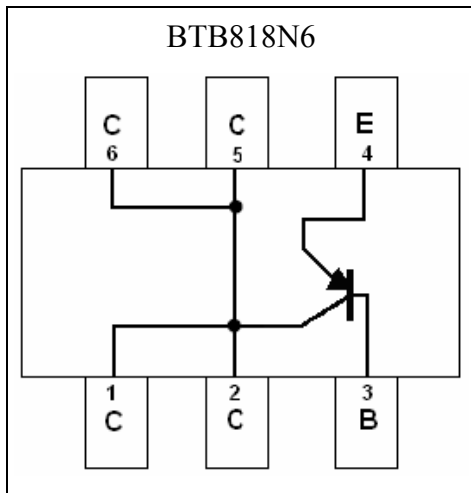
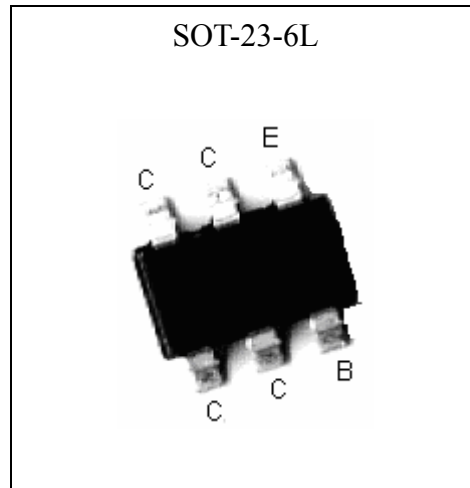

Low Vcesat PNP Epitaxial Planar Transistor

BTB818N6

Features

- Low $V_{CE(sat)}$, $V_{CE(sat)} = -0.2V$ (typical), at $I_C / I_B = -400mA / -20mA$
- Pb-free package

Equivalent Circuit

Outline

Absolute Maximum Ratings ($T_a = 25^\circ C$)

Parameter	Symbol	Limits	Unit
Collector-Base Voltage	V_{CBO}	-40	V
Collector-Emitter Voltage	V_{CEO}	-30	V
Emitter-Base Voltage	V_{EBO}	-7	V
Collector Current(DC)	I_C	-1.5	A
Peak Collector Current	I_{CM}	-3 *1	A
Peak Base Current	I_{BM}	-500	mA
Power Dissipation	P_D	1.2 *2	W
Thermal Resistance, Junction to Ambient	$R_{\theta JA}$	104	$^\circ C/W$
Operating Junction and Storage Temperature Range	$T_j; T_{stg}$	-55~+150	$^\circ C$

 Note :1 Single pulse, $P_w = 10ms$

2. When mounted on 25mm×25mm×1.6 mm FR-4 PCB with high coverage of single sided 1 oz copper, in still air condition.

**Characteristics (Ta=25°C)**

Symbol	Min.	Typ.	Max.	Unit	Test Conditions
BV_{CBO}	-40	-	-	V	$I_C=-50\mu A, I_E=0$
BV_{CEO}	-30	-	-	V	$I_C=-1mA, I_B=0$
BV_{EBO}	-7	-	-	V	$I_E=-50\mu A, I_C=0$
I_{CBO}	-	-	-100	nA	$V_{CB}=-40V, I_E=0$
I_{EBO}	-	-	-100	nA	$V_{EB}=-7V, I_C=0$
* $V_{CE(sat)}$	-	-0.2	-0.3	V	$I_C=-400mA, I_B=-20mA$
* $V_{CE(sat)}$	-	-	-0.4	V	$I_C=-800mA, I_B=-80mA$
* $V_{CE(sat)}$	-	-	-0.6	V	$I_C=-500mA, I_B=-5mA$
* $V_{BE(sat)}$	-	-	-1.1	V	$I_C=-500mA, I_B=-5mA$
* $V_{BE(on)}$	-	-	-1.1	V	$V_{CE}=-2V, I_C=-500mA$
* $h_{FE 1}$	100	-	-	-	$V_{CE}=-1V, I_C=-500mA$
* $h_{FE 2}$	100	-	-	-	$V_{CE}=-3V, I_C=-1A$
f_T	-	150	-	MHz	$V_{CE}=-5V, I_C=-10mA, f=100MHz$
Cob	-	12	-	pF	$V_{CB}=-10V, f=1MHz$

*Pulse Test : Pulse Width $\leq 380\mu s$, Duty Cycle $\leq 2\%$ **Ordering Information**

Device	Package	Shipping	Marking
BTB818N6	SOT-23-6L (Pb-free)	3000 pcs / Tape & Reel	BK

Typical Characteristics

Emitter Grounded Output Characteristics

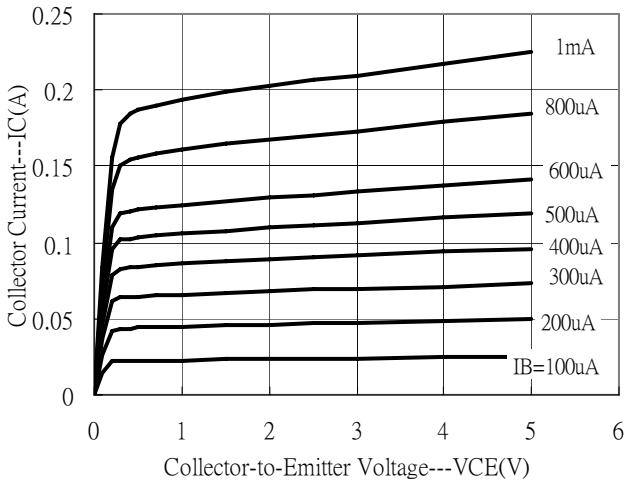

Emitter Grounded Output Characteristics

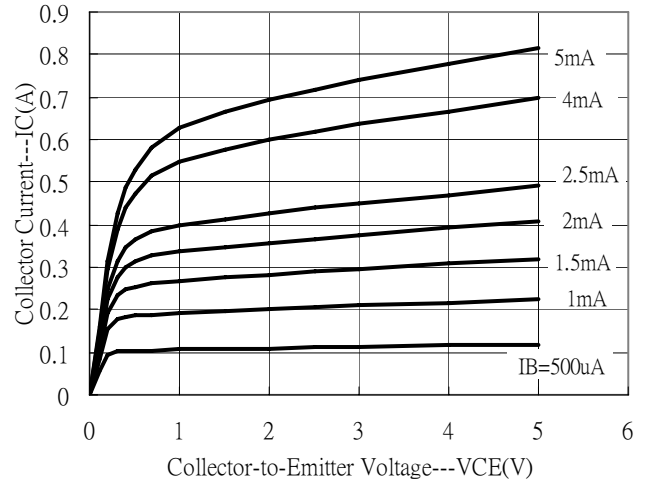

Emitter Grounded Output Characteristics

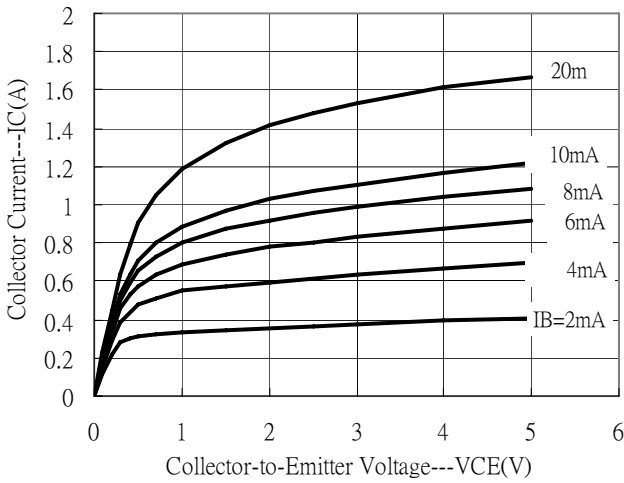

Emitter Grounded Output Characteristics

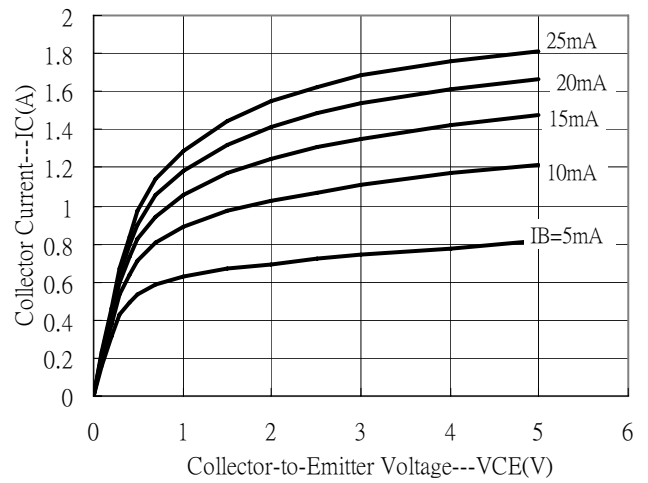

Current Gain vs Collector Current

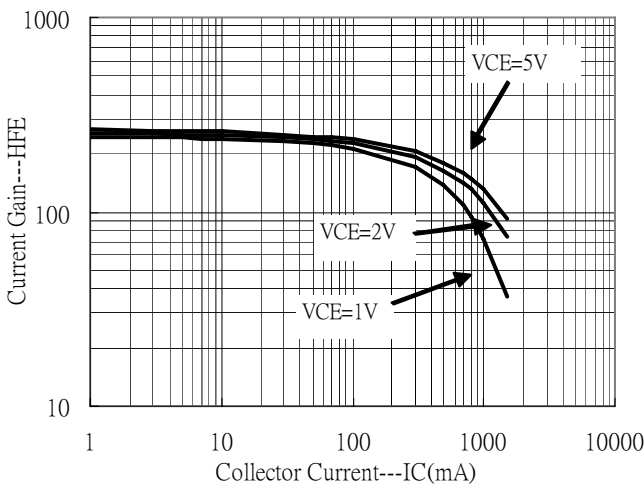

Saturation Voltage vs Collector Current

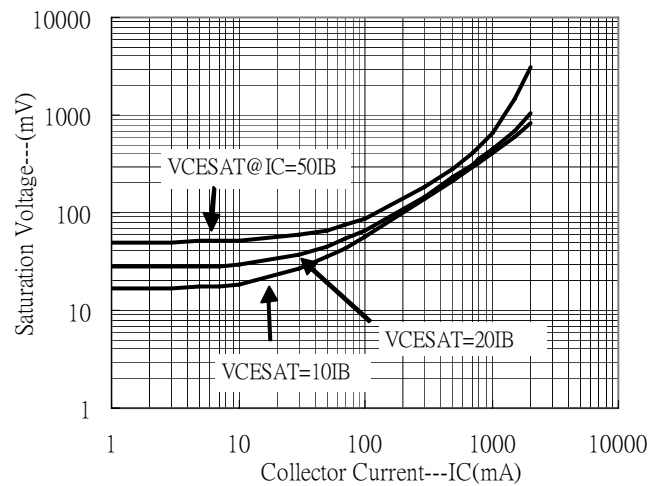

Typical Characteristics(Cont.)

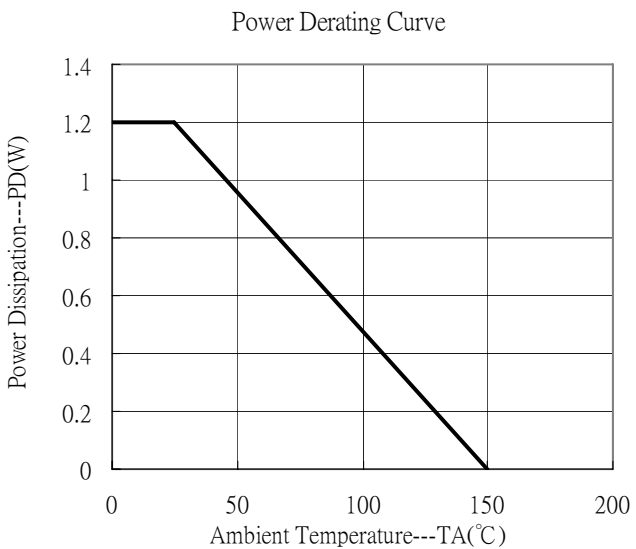
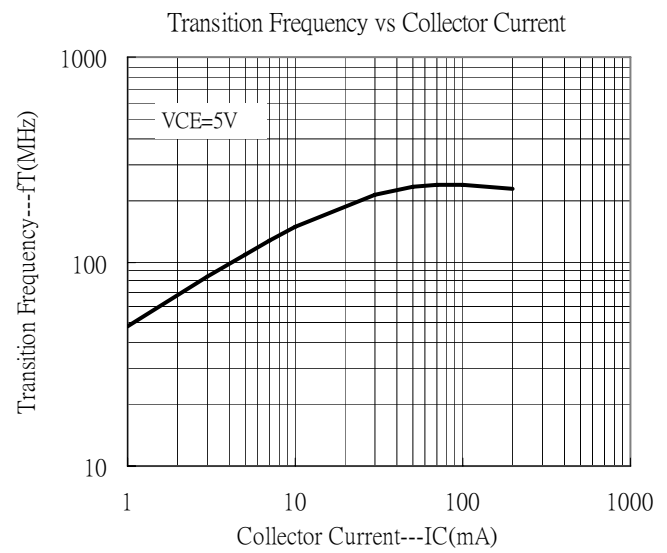
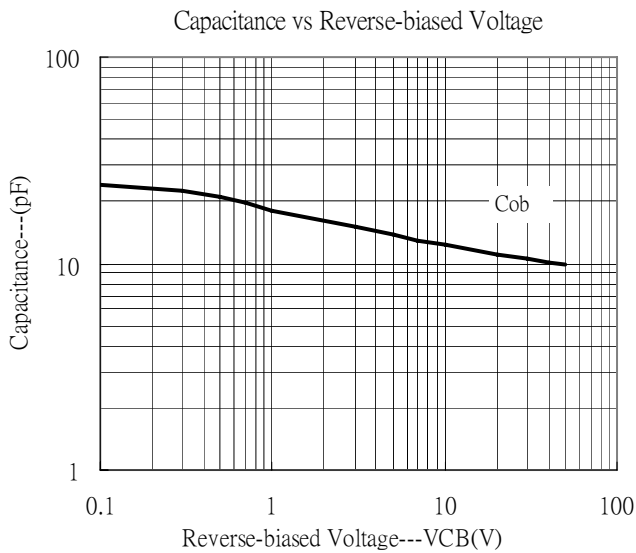
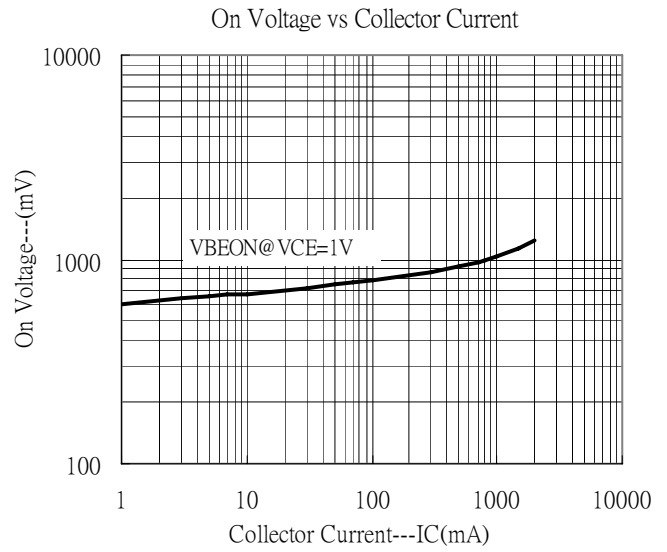
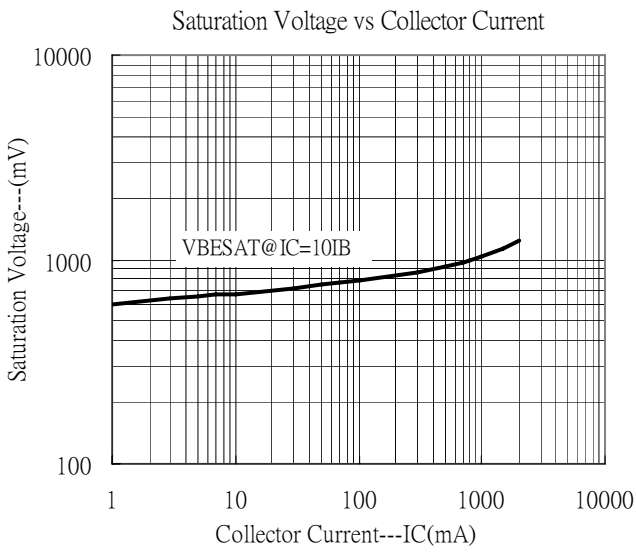

Recommended wave soldering condition

Product	Peak Temperature	Soldering Time
Pb-free devices	260 +0/-5 °C	5 +1/-1 seconds

Recommended temperature profile for IR reflow

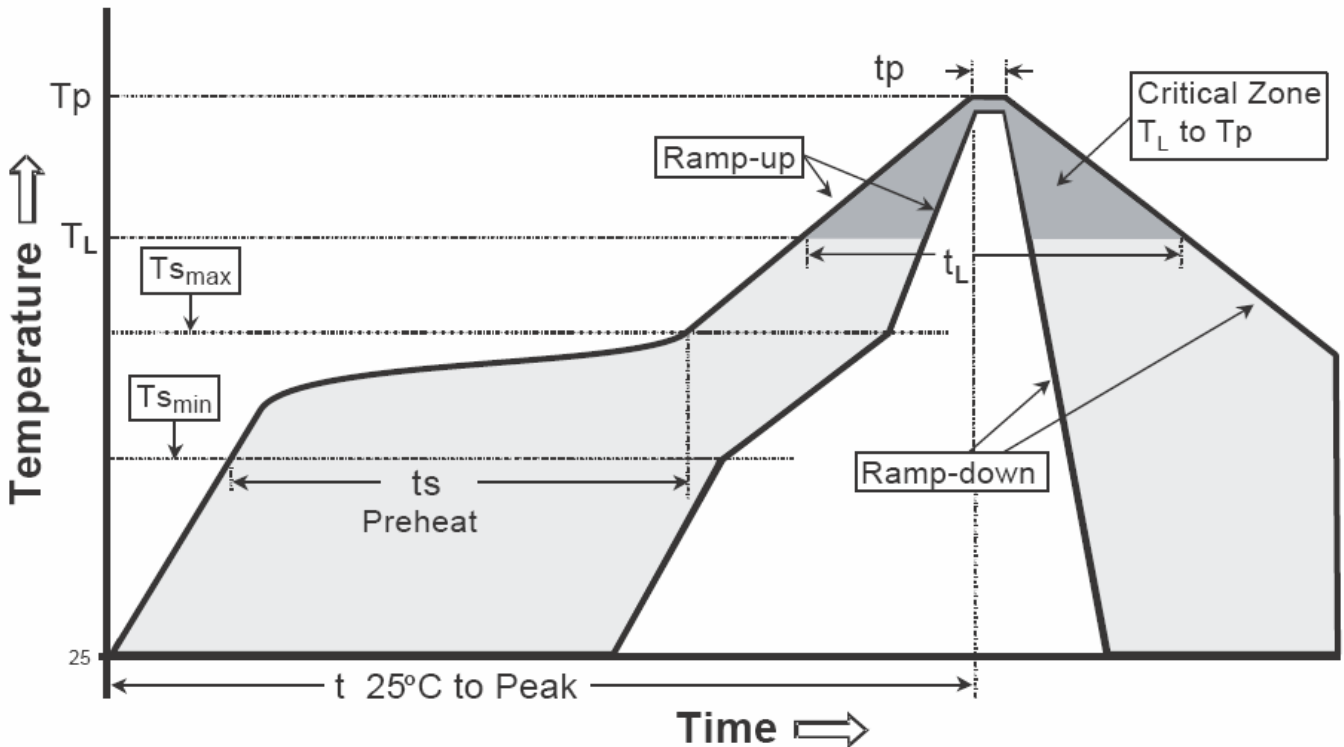

Profile feature	Sn-Pb eutectic Assembly	Pb-free Assembly
Average ramp-up rate (T _{smax} to T _p)	3°C/second max.	3°C/second max.
Preheat		
-Temperature Min(T _{s min})	100°C	150°C
-Temperature Max(T _{s max})	150°C	200°C
-Time(t _{s min} to t _{s max})	60-120 seconds	60-180 seconds
Time maintained above:		
-Temperature (T _L)	183°C	217°C
- Time (t _L)	60-150 seconds	60-150 seconds
Peak Temperature(T _P)	240 +0/-5 °C	260 +0/-5 °C
Time within 5°C of actual peak temperature(tp)	10-30 seconds	20-40 seconds
Ramp down rate	6°C/second max.	6°C/second max.
Time 25 °C to peak temperature	6 minutes max.	8 minutes max.

Note : All temperatures refer to topside of the package, measured on the package body surface.

SOT-23-6L Dimension

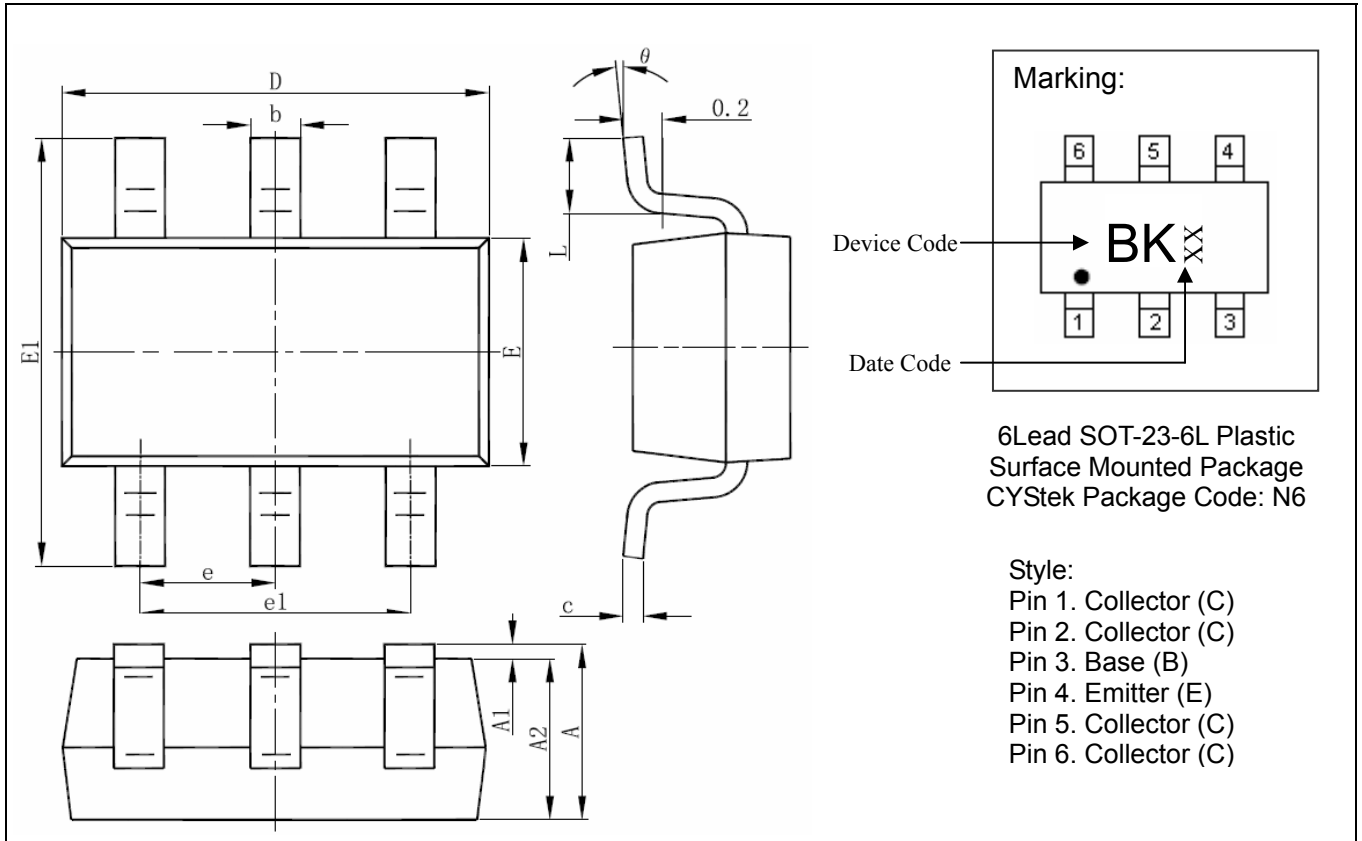

DIM	Millimeters		Inches		DIM	Millimeters		Inches	
	Min.	Max.	Min.	Max.		Min.	Max.	Min.	Max.
A	1.050	1.250	0.041	0.049	E	1.500	1.700	0.059	0.067
A1	0.000	0.100	0.000	0.004	E1	2.650	2.950	0.104	0.116
A2	1.050	1.150	0.041	0.045	e	0.950 (BSC)		0.037 (BSC)	
b	0.300	0.500	0.012	0.020	e1	1.800	2.000	0.071	0.079
c	0.100	0.200	0.004	0.008	L	0.300	0.600	0.012	0.024
D	2.820	3.020	0.111	0.119	θ	0°	8°	0°	8°

Notes : 1.Controlling dimension : millimeters.
 2.Maximum lead thickness includes lead finish thickness, and minimum lead thickness is the minimum thickness of base material.
 3.If there is any question with packing specification or packing method, please contact your local CYStek sales office.

Material :

- Lead : Pure tin plated.
- Mold Compound : Epoxy resin family, flammability solid burning class:UL94V-0.

Important Notice:

- All rights are reserved. Reproduction in whole or in part is prohibited without the prior written approval of CYStek.
- CYStek reserves the right to make changes to its products without notice.
- CYStek **semiconductor products are not warranted to be suitable for use in Life-Support Applications, or systems.**
- CYStek assumes no liability for any consequence of customer product design, infringement of patents, or application assistance.