

Multi Layer Ferrite Power Beads

ISO 9002 CERTIFIED

Type CZP

1. General

- Designed to reduce noise at high frequencies
- Standard EIA Packages: 1J, 2A, 2B
- Nickel barrier with solder overcoat for excellent solderability
- Magnetically shielded

2. Dimensions

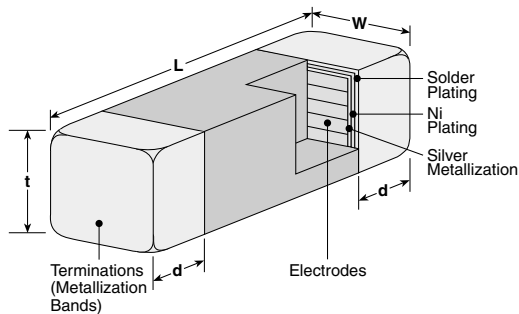

Table 1

| Dimensions - inches (mm) | | | | |
|----------------------------|----------------------------|----------------------------|----------------------------|----------------------------|
| Part | L | W | t | d |
| 1J (0603) | 0.063±0.006 (1.60±0.15) | 0.031±0.006 (0.80±0.15) | 0.031±0.006 (0.80±0.15) | 0.014±0.006 (0.36±0.15) |
| 2A (0805) | 0.079±0.008 (2.00±0.20) | 0.049±0.008 (1.25±0.20) | 0.035±0.008 (0.90±0.20) | 0.020±0.010 (0.51±0.25) |
| 2B (1206) | 0.126±0.008 (3.20±0.20) | 0.063±0.008 (1.60±0.20) | 0.043±0.008 (1.10±0.20) | 0.020±0.010 (0.51±0.25) |

3. Type Designation

The type designation shall be in the following form:

Old Type



New Type

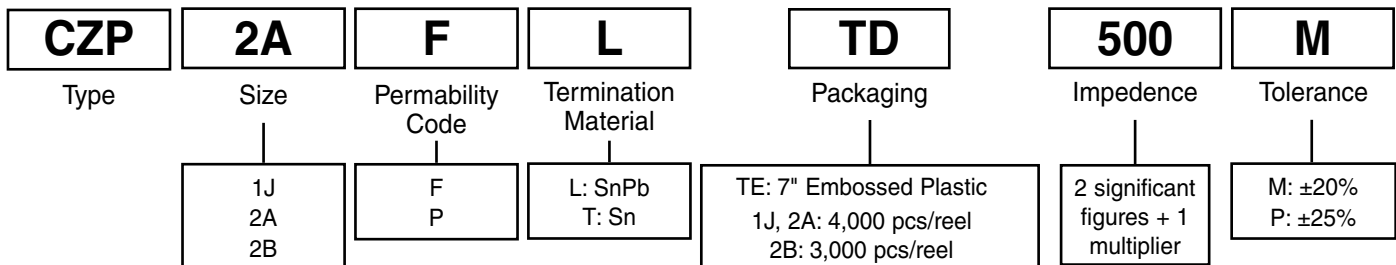

4. Standard Applications

| Ordering Code | Impedance @ 100MHz † Ω | Maximum DC Resistance †† Ω | Allowable DC Current (mA) | Operating Temperature |
|----------------|---------------------------|-------------------------------|---------------------------|-----------------------|
| CZP1JF*TE050** | 5 | 0.04 | 1,000 | -55°C to 125°C |
| CZP1JP*TE100** | 10 | 0.02 | 4,000 | |
| CZP1JF*TE300** | 30 | 0.06 | 3,000 | |
| CZP1JF*TE600** | 60 | 0.1 | 500 | |
| CZP1JF*TE121** | 120 | 0.1 | 2,000 | |
| CZP1JF*TE301** | 300 | 0.1 | 2,000 | |
| CZP2AF*TE070** | 7 | 0.02 | 3,000 | -55°C to 125°C |
| CZP2AF*TE100** | 10 | 0.02 | 3,000 | |
| CZP2AF*TE110** | 11 | 0.025 | 3,000 | |
| CZP2AF*TE150** | 15 | 0.025 | 3,000 | |
| CZP2AF*TE220** | 22 | 0.025 | 3,000 | |
| CZP2AF*TE300** | 30 | 0.025 | 3,000 | |
| CZP2AF*TE400** | 40 | 0.03 | 2,000 | |
| CZP2AF*TE450** | 45 | 0.03 | 2,000 | |
| CZP2AF*TE600** | 60 | 0.025 | 3,000 | |
| CZP2AF*TE800** | 80 | 0.1 | 1,000 | |
| CZP2AF*TE201** | 200 | 0.15 | 1,000 | |
| CZP2AF*TE221** | 220 | 0.05 | 2,000 | |
| CZP2AF*TE301** | 300 | 0.15 | 1,000 | |
| CZP2AF*TE601** | 600 | 0.2 | 1,000 | |
| CZP2AF*TE102** | 1000 | 0.2 | 1,000 | |
| CZP2BF*TE190** | 19 | 0.02 | 3,000 | -55°C to 125°C |
| CZP2BF*TE260** | 26 | 0.02 | 3,000 | |
| CZP2BF*TE300** | 30 | 0.02 | 3,000 | |
| CZP2BF*TE310** | 31 | 0.02 | 3,000 | |
| CZP2BF*TE500** | 50 | 0.025 | 3,000 | |
| CZP2BF*TE650** | 65 | 0.03 | 2,000 | |
| CZP2BF*TE700** | 70 | 0.03 | 2,000 | |
| CZP2BF*TE800** | 80 | 0.03 | 2,000 | |

*Add Termination Material Character (L,T) ** Add Tolerance Character (J, K, M, P)
 † Impedance Test Method: HP4291A †† DCR Test Method: Keithley 580

4. Standard Applications (continued)

| Ordering Code | Impedance @ 100MHz † Ω | Maximum DC Resistance †† Ω | Allowable DC Current (mA) | Operating Temperature |
|----------------|---------------------------|-------------------------------|---------------------------|-----------------------|
| CZP2BF*TE900** | 90 | 0.1 | 1,000 | -55°C to 125°C |
| CZP2BF*TE101** | 100 | 0.1 | 1,000 | |
| CZP2BF*TE121** | 120 | 0.1 | 1,000 | |
| CZP2BP*TE700** | 70 | 0.2 | 3,000 | |
| CZP2BF*TE601** | 600 | 0.2 | 1,000 | |
| CZP2BP*TE101** | 100 | 0.03 | 3,000 | |
| CZP2BP*TE121** | 120 | 0.04 | 3,000 | |
| CZP2BP*TE601** | 600 | 0.1 | 1,500 | |

*Add Termination Material Character (L,T) ** Add Tolerance Character (J, K, M, P)
 † Impedance Test Method: HP4291A †† DCR Test Method: Keithley 580

5. 0603 (1J) Graphs

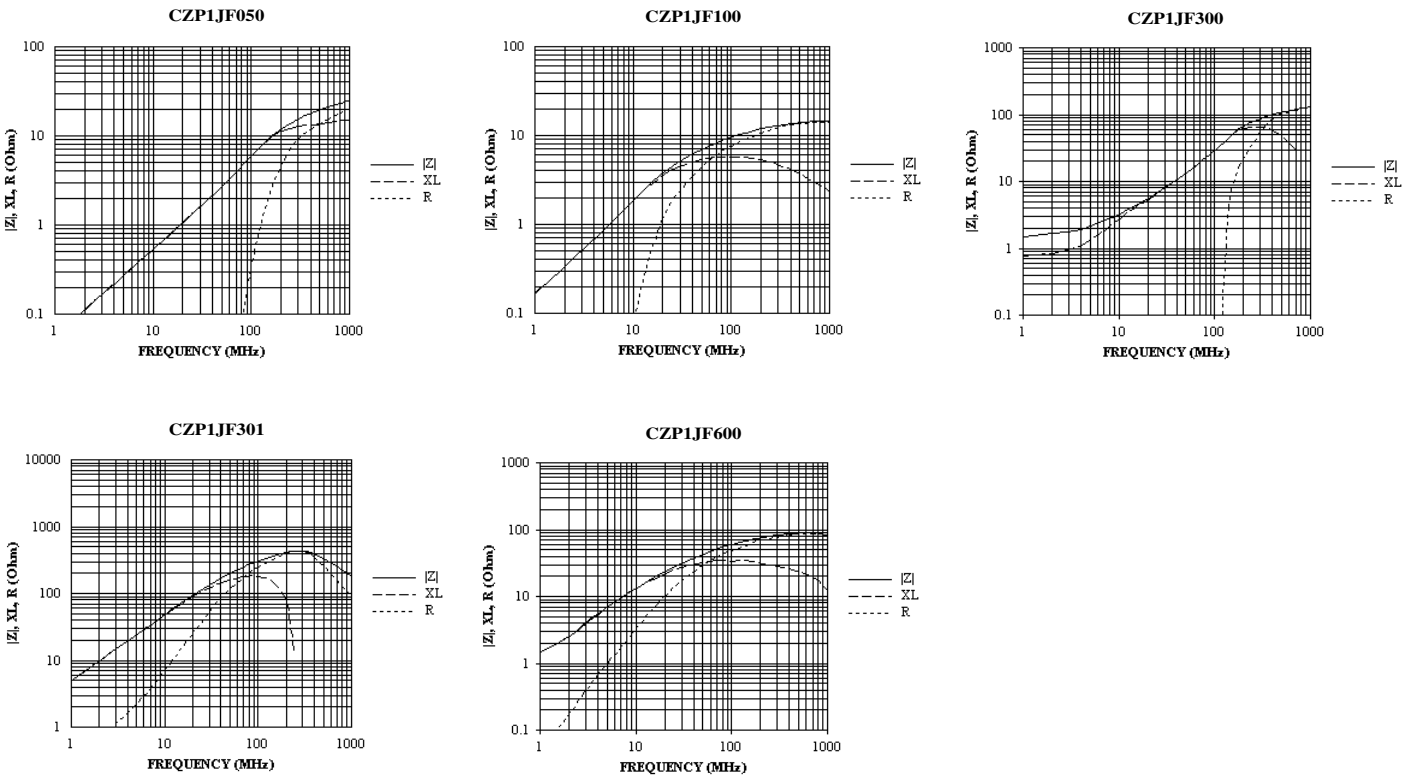

5. 0805 (2A) Graphs

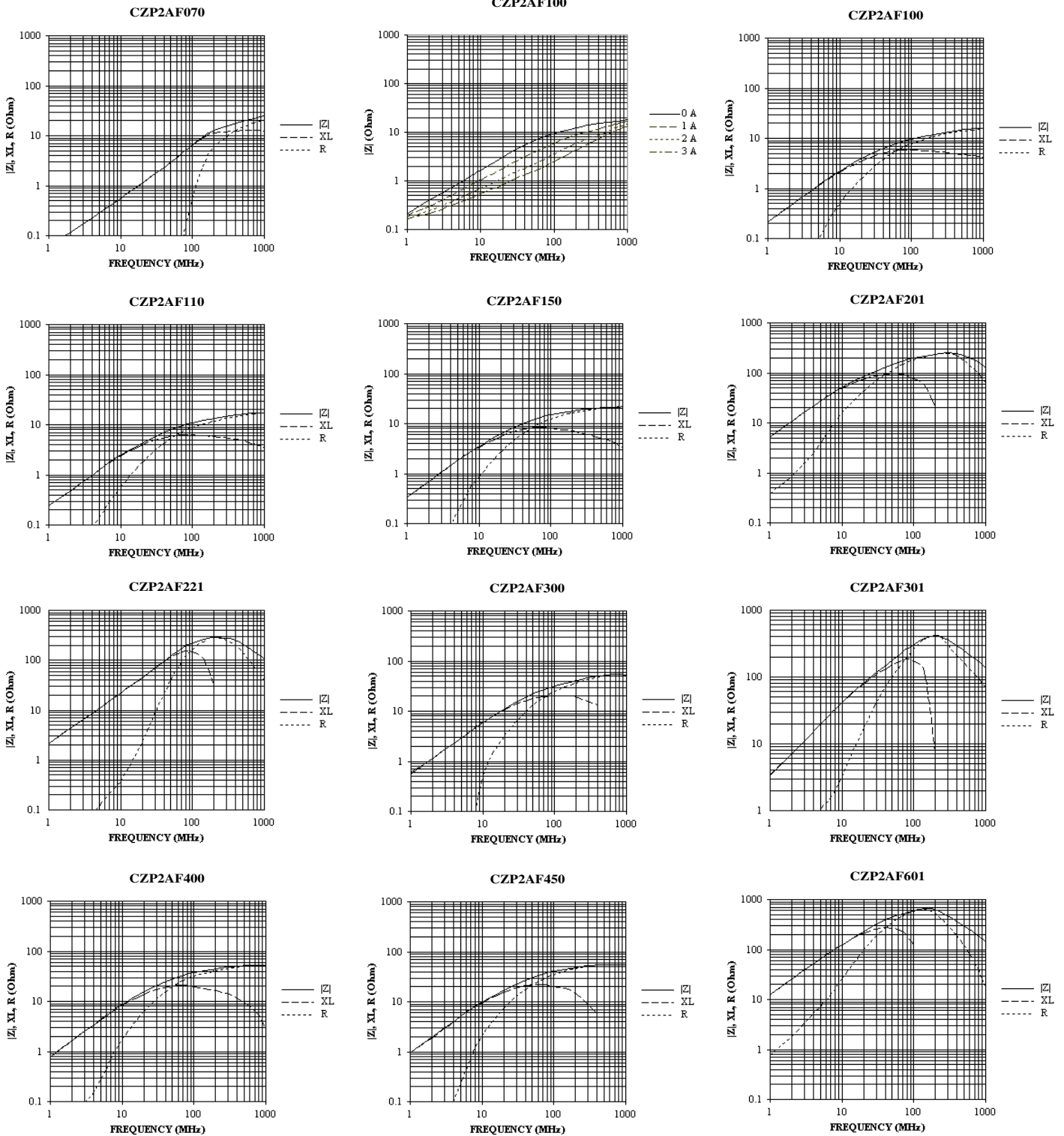

5. 0805 (2A) Graphs (continued)

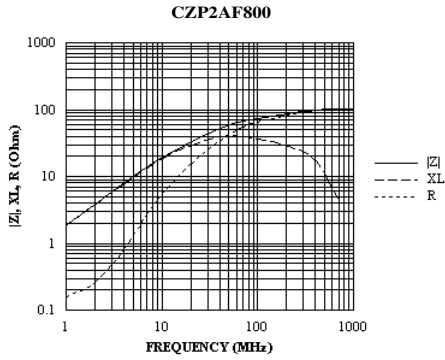

5. 1206 (2B) Graphs

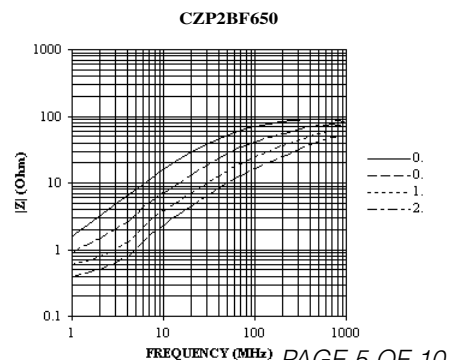
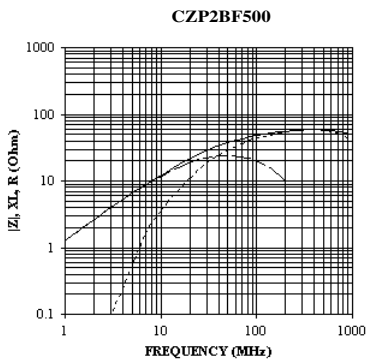
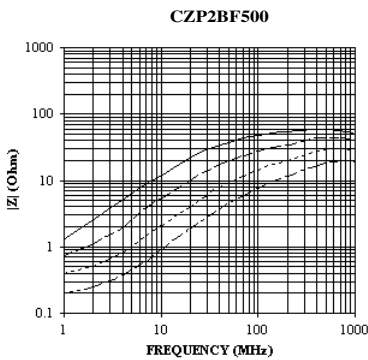
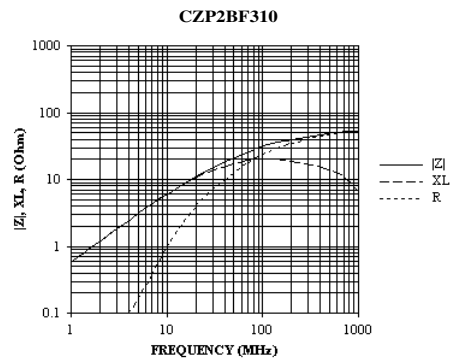
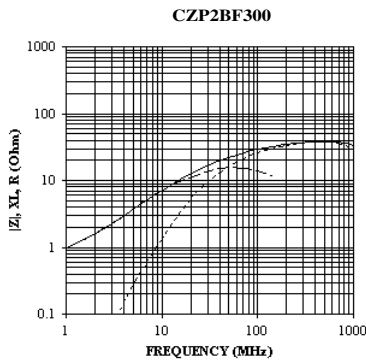
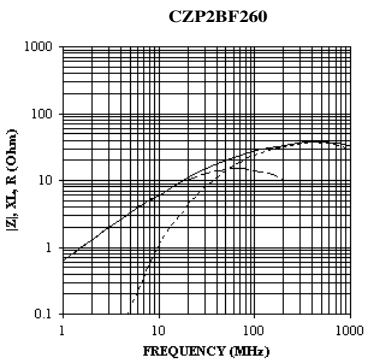
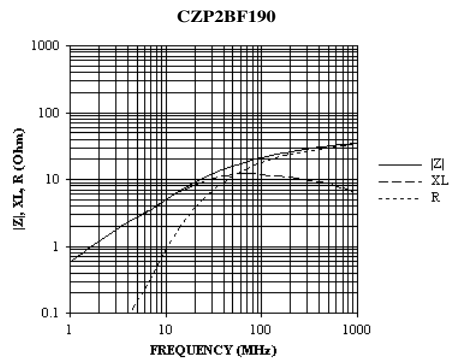
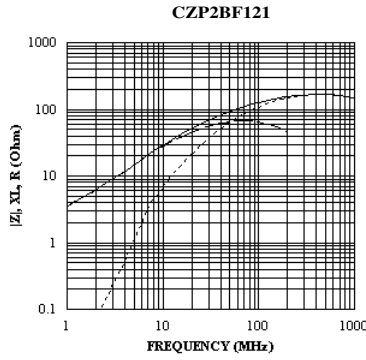
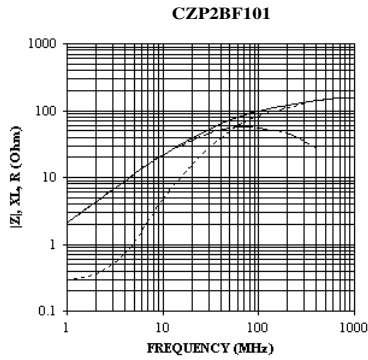

5. 1206 (2B)Graphs (continued)

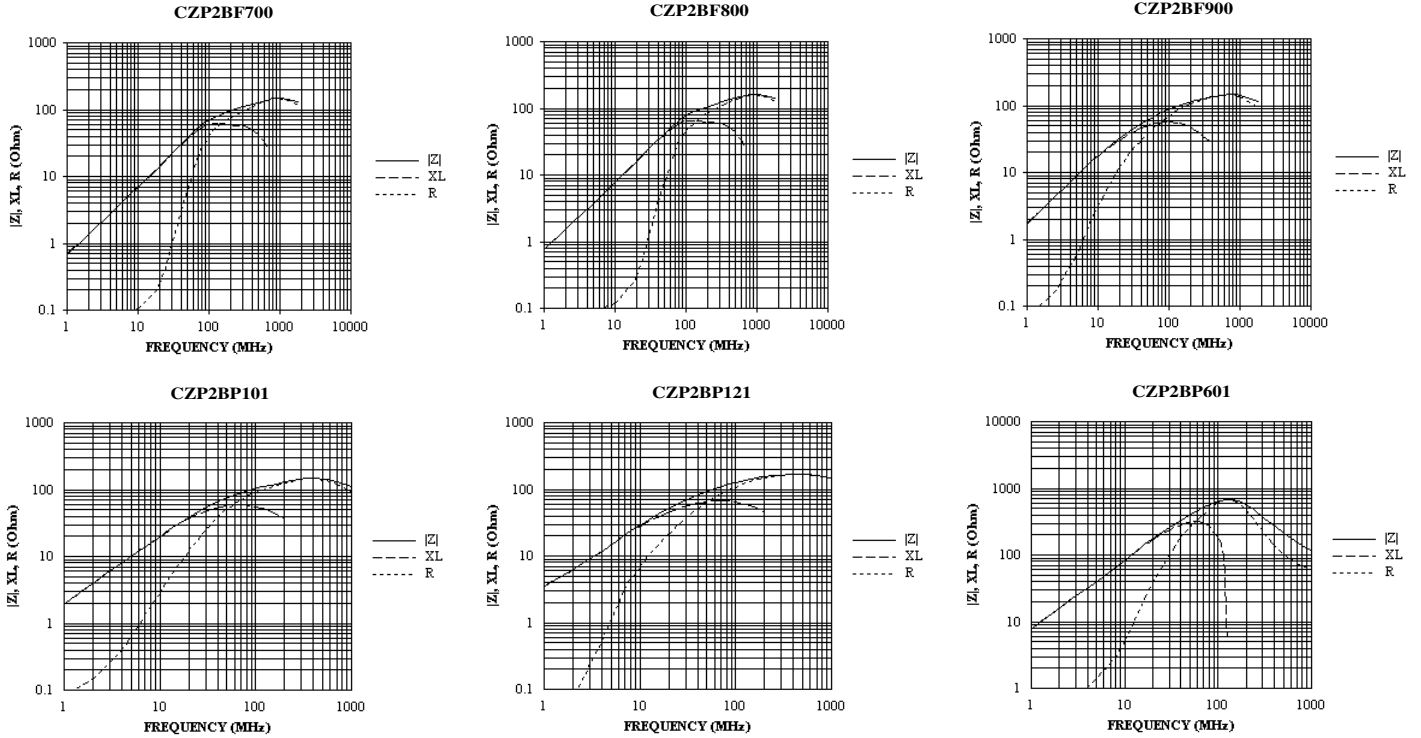

5. Characteristics

| Item | Requirement | Conditions | | | | | | | | | | | | |
|----------------------------------|--|---|------|--------|------|----|-----|--------------------|----|-----|--------------------|----|-----|--------------------|
| Operating Temperature | -55°C ~ +125°C | | | | | | | | | | | | | |
| Storage Temperature | 40°C @ 70% Humidity | Sealed plastic bags with desiccant shall be used to reduce the potential of oxidation on the terminations during storage. | | | | | | | | | | | | |
| Resistance to Solder Heat | Change in Impedance: Relative to value before test $\pm 20\%$. Appearance: There shall be no cracking Solder Coverage: More than 75% of the terminal electrode shall be covered with solder. | Flux: 5-10 sec dip After Flux: Air dry for 15 sec Preheat: 150°C $\pm 10^\circ\text{C}$ Preheat Time: 60 sec Solder Temp: 260°C $\pm 5^\circ\text{C}$ Dip Time: 10 ± 1 sec | | | | | | | | | | | | |
| Solderability | Solder Coverage: More than 95% of the termination shall be covered with solder. | Flux: 5-10 sec dip After Flux: Air dry for 15 sec Solder Temp: 245°C $\pm 5^\circ\text{C}$ Dip Time: 5 ± 0.5 sec | | | | | | | | | | | | |
| Leach Resistance | Appearance: There shall be no visible signs of physical or mechanical damage (i.e. no cracks). Terminations: Termination must not be leached away for more than 5%. | The bead shall be subjected to the following 5 steps for the period of time shown below. The 5 steps constitute one (1) rotation. 4 rotations shall be carried out. 1) Flux: 5-10 sec 2) After Flux: Air dry for 15 sec 3) Solder Temp: 230°C $\pm 5^\circ\text{C}$ 4) Dip Time: 5 ± 0.5 sec 5) Cool: Air cool for 60 seconds | | | | | | | | | | | | |
| Insulation Resistance | Insulation Resistance: Min 1G ohms | | | | | | | | | | | | | |
| Solvent Resistance | Change in Impedance: Relative to value before test $\pm 10\%$. | Cleaning by: Washer: Ultrasonic washer (100W) Solvent: Isopropyl alcohol Time: 3 minutes | | | | | | | | | | | | |
| Terminal Strength (hanging test) | Appearance: The terminal electrode shall not break off, nor shall there be damage to the body. | <table border="1"> <thead> <tr> <th>Type</th> <th>W(kgf)</th> <th>Time</th> </tr> </thead> <tbody> <tr> <td>1J</td> <td>0.5</td> <td>30 sec ± 2 sec</td> </tr> <tr> <td>2A</td> <td>1.0</td> <td>30 sec ± 2 sec</td> </tr> <tr> <td>2B</td> <td>1.5</td> <td>30 sec ± 2 sec</td> </tr> </tbody> </table> | Type | W(kgf) | Time | 1J | 0.5 | 30 sec ± 2 sec | 2A | 1.0 | 30 sec ± 2 sec | 2B | 1.5 | 30 sec ± 2 sec |
| Type | W(kgf) | Time | | | | | | | | | | | | |
| 1J | 0.5 | 30 sec ± 2 sec | | | | | | | | | | | | |
| 2A | 1.0 | 30 sec ± 2 sec | | | | | | | | | | | | |
| 2B | 1.5 | 30 sec ± 2 sec | | | | | | | | | | | | |
| Terminal Strength (push test) | Appearance: There shall be no evidence of mechanical degradations to terminals or body. | <table border="1"> <thead> <tr> <th>Type</th> <th>W(kgf)</th> <th>Time</th> </tr> </thead> <tbody> <tr> <td>1J</td> <td>1.4</td> <td>60 sec</td> </tr> <tr> <td>2A</td> <td>1.8</td> <td>60 sec</td> </tr> <tr> <td>2B</td> <td>2.3</td> <td>60 sec</td> </tr> </tbody> </table> | Type | W(kgf) | Time | 1J | 1.4 | 60 sec | 2A | 1.8 | 60 sec | 2B | 2.3 | 60 sec |
| Type | W(kgf) | Time | | | | | | | | | | | | |
| 1J | 1.4 | 60 sec | | | | | | | | | | | | |
| 2A | 1.8 | 60 sec | | | | | | | | | | | | |
| 2B | 2.3 | 60 sec | | | | | | | | | | | | |
| Bending Strength | Appearance: There shall be no physical or mechanical damage. Impedance: Relative to initial value before test $\pm 10\%$. | Board: 90x40x1.6mm Bend: 1mm Time: 5 sec | | | | | | | | | | | | |

5. Characteristics (continued)

| Item | Requirement | Conditions | | | | | | | | | | | | | | | | | | |
|------------------|--|--|------|-------------|------|---------|-----------------------------|-------|--------|-----------------------------|--------------------|------------|-------|--------------|--------|------------------------------|--------------------|------------|-------|--------------|
| Mechanical Shock | <p>Appearance: There shall be no physical or mechanical damage.</p> <p>Impedance: Relative to initial value before test $\pm 10\%$.</p> | <p>Force: 50G</p> <p>Time: 11 msec</p> <p>There shall be 3 shocks in each of 6 directions (18 shocks total).</p> | | | | | | | | | | | | | | | | | | |
| Vibration | <p>Impedance: Relative to initial value $\pm 10\%$.</p> | <p>Only endurance conditioning by sweeping shall be made. The entire frequency range from 10-2,000Hz and return to 10Hz in 20 minutes (this shall constitute one cycle).</p> <p>Amplitude: 1.5mm</p> <p>The test shall have a 15G peak and shall be applied for a period of 4 hours (12 cycles) in each of 3 mutually perpendicular directions (a total of 36 cycles within a total of 12 hours).</p> | | | | | | | | | | | | | | | | | | |
| Thermal Shock | <p>Appearance: There shall be no physical or mechanical damage.</p> <p>Impedance: Relative to initial value $\pm 20\%$.</p> <p>DCR: The DCR shall not exceed initial specified value.</p> <p>Testing of the parts will be made at 0 hours, 250 hours and 500 hours. Before testing, the parts shall be allowed to cool to room temperature for 24 hours.</p> | <table border="1"> <thead> <tr> <th>Step</th> <th>Temperature</th> <th>Time</th> </tr> </thead> <tbody> <tr> <td>1-start</td> <td>-40°C $\pm 2^\circ\text{C}$</td> <td>_____</td> </tr> <tr> <td>2-hold</td> <td>-40°C $\pm 2^\circ\text{C}$</td> <td>30 min ± 5 min</td> </tr> <tr> <td>3-transfer</td> <td>_____</td> <td>0.5 min max.</td> </tr> <tr> <td>4-hold</td> <td>+105°C $\pm 2^\circ\text{C}$</td> <td>30 min ± 5 min</td> </tr> <tr> <td>5-transfer</td> <td>_____</td> <td>0.5 min max.</td> </tr> </tbody> </table> <p>Steps 1 thru 5 constitute one complete cycle and the test shall consist of a total of 500 cycles.</p> | Step | Temperature | Time | 1-start | -40°C $\pm 2^\circ\text{C}$ | _____ | 2-hold | -40°C $\pm 2^\circ\text{C}$ | 30 min ± 5 min | 3-transfer | _____ | 0.5 min max. | 4-hold | +105°C $\pm 2^\circ\text{C}$ | 30 min ± 5 min | 5-transfer | _____ | 0.5 min max. |
| Step | Temperature | Time | | | | | | | | | | | | | | | | | | |
| 1-start | -40°C $\pm 2^\circ\text{C}$ | _____ | | | | | | | | | | | | | | | | | | |
| 2-hold | -40°C $\pm 2^\circ\text{C}$ | 30 min ± 5 min | | | | | | | | | | | | | | | | | | |
| 3-transfer | _____ | 0.5 min max. | | | | | | | | | | | | | | | | | | |
| 4-hold | +105°C $\pm 2^\circ\text{C}$ | 30 min ± 5 min | | | | | | | | | | | | | | | | | | |
| 5-transfer | _____ | 0.5 min max. | | | | | | | | | | | | | | | | | | |
| Load Humidity | <p>Appearance: There shall be no physical or mechanical damage.</p> <p>Impedance: Relative to initial value $\pm 15\%$.</p> <p>Measurements shall be taken at 0 hours, 250 hours, 500 hours and 1,000 hours and shall meet the conditions stated above.</p> | <p>Temperature: 85°C $\pm 2^\circ\text{C}$</p> <p>Relative Humidity: 85%</p> <p>Time: 1,000 hours total</p> <p>Apply: 100% rated current</p> | | | | | | | | | | | | | | | | | | |
| Life Test | <p>Appearance: There shall be no physical or mechanical damage</p> <p>Impedance: Relative to initial value $\pm 15\%$</p> <p>Measurements shall be taken at 0 hours, 250 hours, 500 hours and 1,000 hours and shall meet the conditions stated above.</p> | <p>Temperature: 85°C $\pm 2^\circ\text{C}$</p> <p>Time: 1,000 hours total</p> <p>Apply: 100% rated current</p> | | | | | | | | | | | | | | | | | | |

6. Packaging Specifications

KOA's multilayer components are provided on tape-and-reel for use in pick-and-place machines. The reel size is 7 inch.

7. Dimensions - inches (mm)

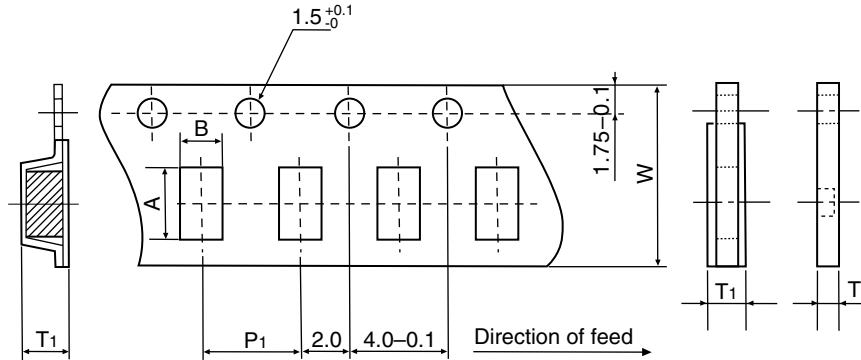

Dimensions - inches (mm)

| Tape | A | B | W | P ₁ | T ₁ |
|--------------------|--------------------------|--------------------------|--------------------------|--------------------------|--------------------------|
| 1J 0603 | 0.075±0.002 (1.9±0.1) | 0.043±0.002 (1.1±0.1) | 0.318±0.002 (8.1±0.1) | 0.157±0.004 (4.0±0.1) | 0.043±0.002 (1.1±0.1) |
| 2A 0805 | 0.093±0.002 (2.4±0.1) | 0.063±0.002 (1.6±0.1) | 0.318±0.002 (8.1±0.1) | 0.157±0.004 (4.0±0.1) | 0.046±0.002 (1.2±0.1) |
| 2B 1206 | 0.138±0.002 (3.5±0.1) | 0.071±0.002 (1.8±0.1) | 0.318±0.002 (8.1±0.1) | 0.157±0.004 (4.0±0.1) | 0.071±0.002 (1.8±0.1) |

Dimensions - inches (mm)

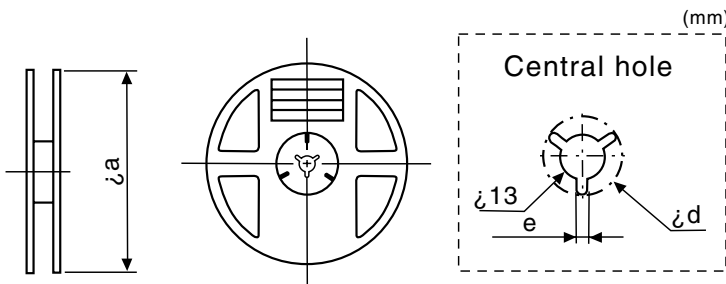

| Tape | øa | ød | e |
|--------------------|------------|---------------|----------------|
| 1J 0603 | | | |
| 2A 0805 | 7 (178) | 0.827 (21) | 0.079 (2.0) |
| 2B 1206 | | | |

9. Recommended PC Board Land Patterns - mm (inches)

| Chip Size | L | G | H |
|------------------|-------------|-------------|-------------|
| 1J (0603) | 2.6 (0.102) | 0.6 (0.023) | 0.8 (0.031) |
| 2A (0805) | 3.0 (0.118) | 1.0 (0.039) | 1.0 (0.039) |
| 2B (1206) | 4.4 (0.173) | 2.2 (0.087) | 1.4 (0.055) |

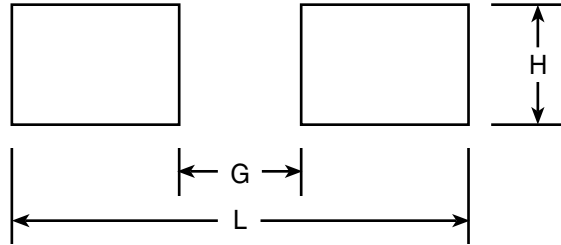

10. Recommended Temperature Profiles for Soldering

Recommended Temperature Profile for Wave Soldering

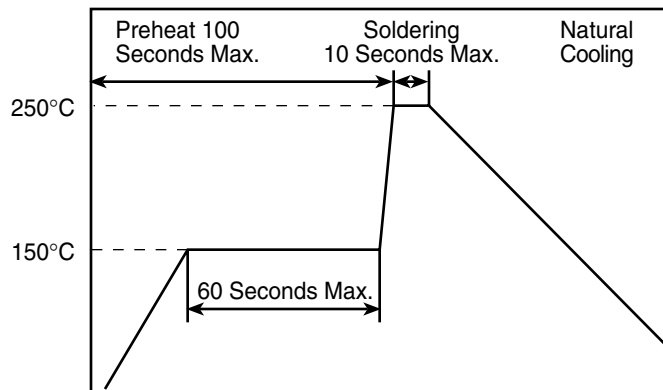

Recommended Temperature Profile for Reflow Soldering

