

Version : 5.0

TECHNICAL SPECIFICATION
MODEL NO : PA025XSC

The content of this information is subject to be changed without notice.
Please contact PVI or its agent for further information.

Customer's Confirmation

Customer _____

Date _____

By _____

PVI's Confirmation

Confirmed By _____

Prepared By _____

Revision History

Rev.	Issued Date	Revised Contents
1.0	Aug.13, 2004	New
1.1	Jan.11, 2005	Removed Page 25: Indication of Lot Number Label Add Page 25: Reliability Test (Note: The protective film must be removed before temperature test)
1.2	Jun.07, 2005	Modify: Page03: Weight tolerance change to 18±2 Page25: Packing – change tray & cushion
1.3	Dec.22, 2005	1. Page 3: Outline Dimension Add FPC PI Tape outline . 2. Page 5 : 5. Input / Output Terminals Modify FPC pin No.23 Form V _{EE} to N/C (No connection) 3. Page 25. 12. Reliability Test Add High Temperature Operation Test=60°C ,240hrs
5.0	Nov 12 , 2007	Page 27 14. Packing Delete carton packing

TECHNICAL SPECIFICATION***CONTENTS***

<i>NO.</i>	<i>ITEM</i>	<i>PAGE</i>
-	Cover	1
-	Revision History	2
-	Contents	3
1	Application	4
2	Features	4
3	Mechanical Specifications	4
4	Mechanical Drawing of TFT-LCD module	5
5	Input / Output Terminals	6
6	Pixel Arrangement	8
7	Absolute Maximum Ratings	9
8	Electrical Characteristics	9
9	Power On Sequence	20
10	Optical Characteristics	20
11	Handling Cautions	24
12	Reliability Test	25
13	Block Diagram	26
14	Packing	27
-	Appendix	28

1. Application

This technical specification applies to 2.5" color TFT-LCD panel. The 2.5" color TFT LCD panel is designed for camcorder, digital camera application and other electronic products which require high quality flat panel displays.

2. Features

- .Amorphous silicon TFT-LCD panel with LED backlight unit
- . Compatible with NTSC & PAL system
- .High Resolution : 112,320 Dots
- . Slim and compact
- .Optimum Viewing Direction: 6 o'clock
- . Up/Down and Left/Right Image Reversion

3. Mechanical Specifications

Parameter	Specifications	Unit
Screen Size	2.45(diagonal)	inch
Surface Treatment	Anti - Glare	
Display Format	160×(R,G,B)×234	dot
Active Area	49.68(H) × 37.44(V)	mm
Pixel Pitch	0.310(H) × 0.160(V)	mm
Pixel configuration	Delta	
Outline Dimension	60.6(W)×48.4 (H)×3.45 (D)(typ.)	mm
Back-light	4-LED	-
Weight	18±2	g
Display mode	Normally white	
Gray scale inversion direction	6 (Note 10-1)	o'clock

4. Mechanical Drawing of TFT-LCD Module

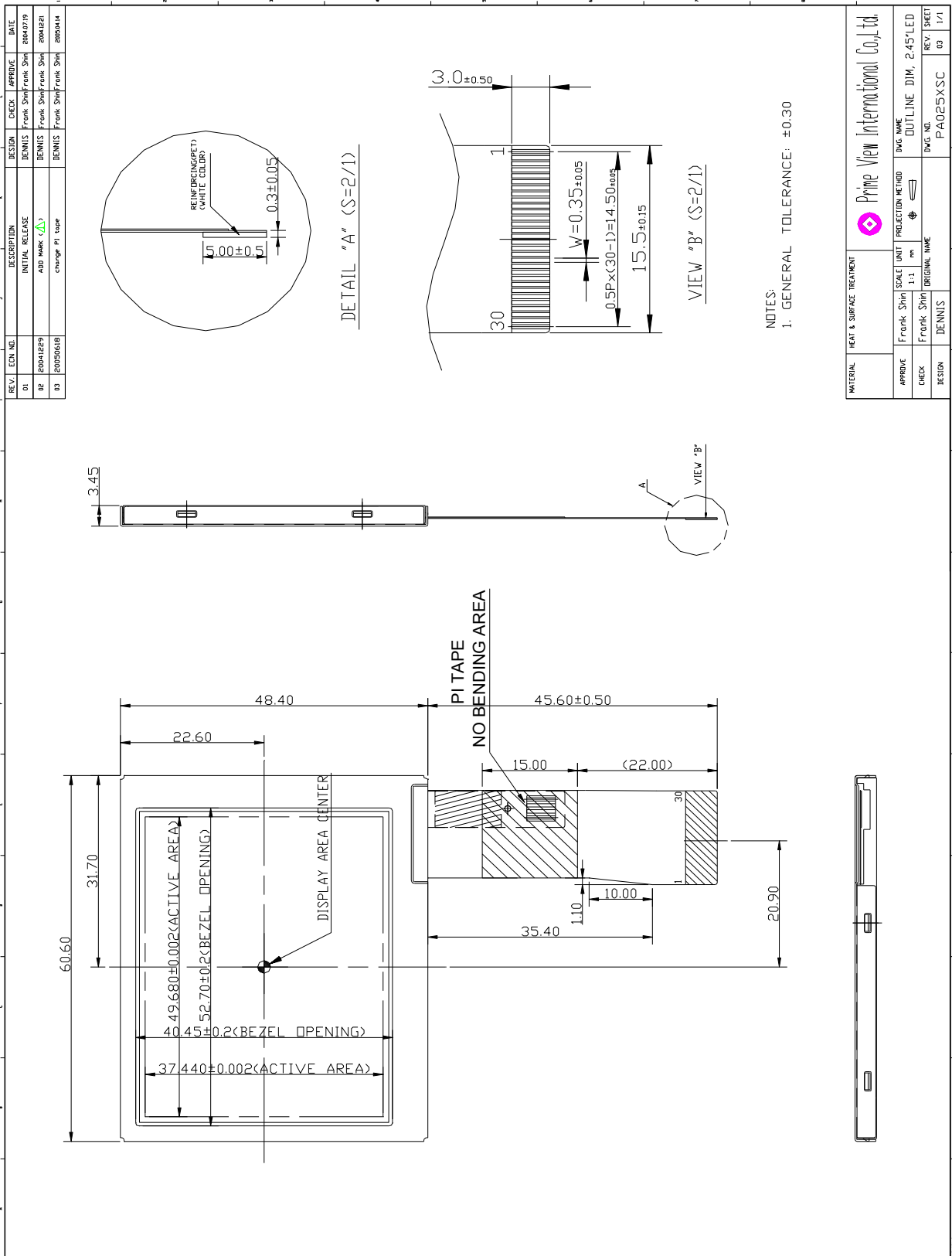

NOTES:
1. GENERAL TOLERANCE: ±0.30

MATERIAL		HEAT & SURFACE TREATMENT		Prime View International Co., Ltd.	
APPROVE	Frunk Shm	SCALE	UNIT	DWG NAME	OUTLINE DIM. 245*LED
CHECK	Frunk Shm	1:1	mm	PROJECTION METHOD	1st Angle
DESIGN	DENNIS	ORIGINAL NAME		DWG NO.	PA025XSC
				REV.	SHEET
				03	1/1

5. Input / Output Terminals

TFT-LCD Module Connector

FPC Down Connect , 30Pins , Pitch : 0.5 mm

Pin No	Symbol	I/O	Description	Remark
1	STH1	I/O	Start pulse for source driver	Note5-6
2	AV _{SS}	I	Analog GND for source driver	
3	AV _{DD}	I	Analog power input for source driver	Note5-3
4	V _B	I	Video Input B	Note5-1
5	V _G	I	Video Input G	
6	V _R	I	Video Input R	
7	V _{SS}	I	Digital GND	
8	V _{DD}	I	Digital power input	Note5-3
9	CPH1	I	Sampling and shift clock for source driver	
10	CPH2	I	Sampling and shift clock for source driver	
11	CPH3	I	Sampling and shift clock for source driver	
12	STH2	I/O	Start pulse for source driver	Note5-6
13	Q2H	I	Video input rotation control	
14	INH	I	Output enable for source driver	
15	R/L	I	Left/Right Control for source driver	Note5-6
16	V _{COM}	I	Common electrode voltage	Note5-1
17	XOE	I	Output enable for gate driver	
18	CPV	I	Clock input for gate driver	
19	U/D	I	Up/Down Control for gate driver	Note5-6
20	DIO2	I/O	Vertical start pulse	Note5-6
21	DIO1	I/O	Vertical start pulse	
22	V _{GL}	I	Gate off voltage(alternative every 1-H)	Note5-2
23	NC	-	No connection	
24	V _{SS}	I	GND	
25	V _{CC}	I	Logic power for gate driver	Note5-3
26	V _{GH}	I	Gate on voltage	Note5-4
27	NC	-	No connection	
28	NC	-	No connection	
29	GLED	I	Ground for LED backlight	
30	VLED	I	Supply voltage for LED backlight	Note5-5

Note 5-1 $V_{COM(TYP.)} = 6V_{PP}$.

Phase of the video signal input and V_{COM}

The relation between these values could refer to 8-1 Operating condition.

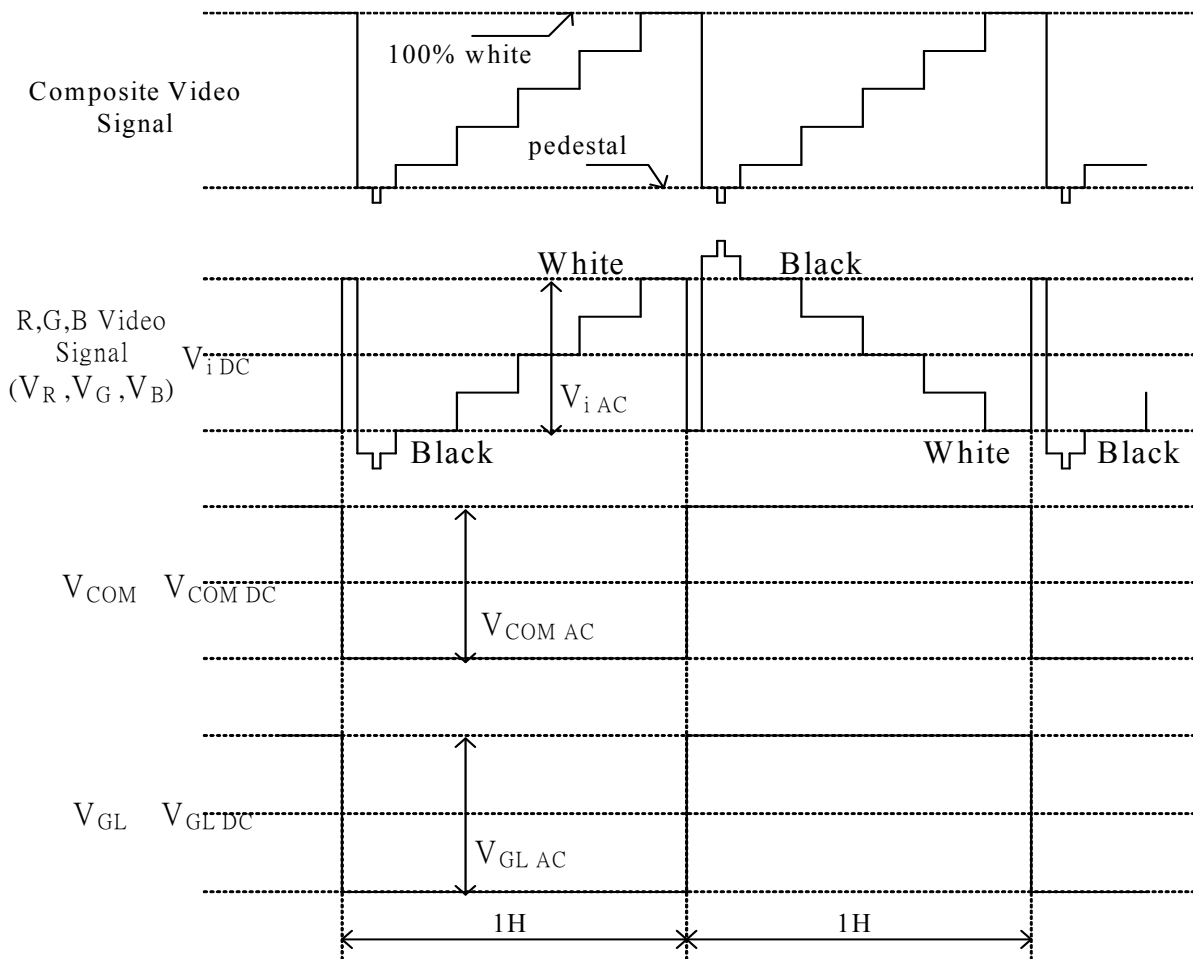

Fig.1

Liquid crystal transmission of the video signal input, V_{COM} and timing

	V_{COM}	
	H Level	L Level
Video Signal Input Maximum	Black	White
Video Signal Input Minimum	White	Black

White : maximum transmission / Black : minimum transmission

Note 5 – 2 : $V_{GL(TYP.)} = -12V$

Note 5 – 3 : $V_{DD(TYP.)}, V_{CC(TYP.)} = +3.3V, AV_{DD(TYP.)} = 5.0V$

Note 5 – 4 : $V_{GH(TYP.)} = +15V$

Note 5 – 5 : $V_{LED} = 20mA$

Note 5 – 6 : STH1, STH2 and R/L mode

R/L	STH1	STH2	Remark
High(V _{DD})	Input	Output	Left to Right
Low(0 Volt.)	Output	Input	Right to Left

DIO1,DIO2,and U/D mode

U/D	DIO1	DIO2	Remark
High(V _{CC})	Input	Output	Down to Up
Low(0 Volt.)	Output	Input	Up to Down

U/D(PIN 19)=High R/L(PIN 15)=Low

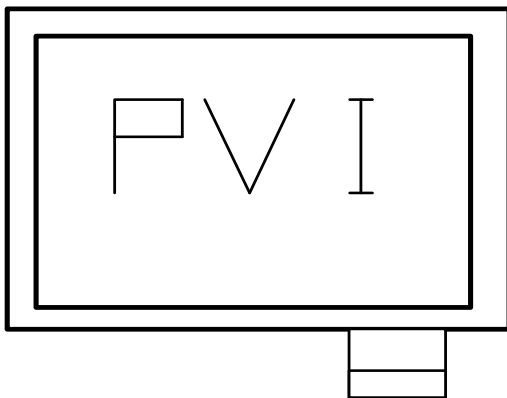

U/D(PIN 19)=Low R/L(PIN 15)=High

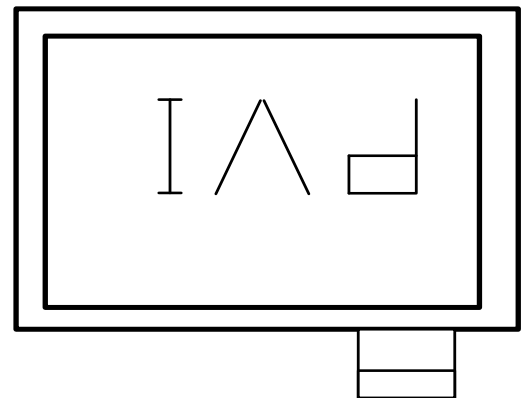

6. Pixel Arrangement

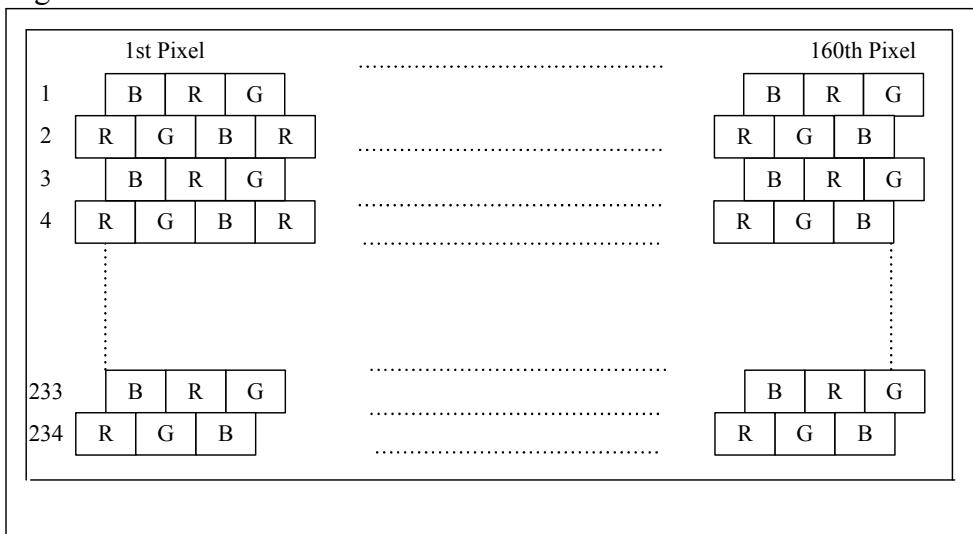

7. Absolute Maximum Ratings :

The followings are maximum values , which if exceeded, may cause faulty operation or damage to the unit.

$$\text{GND} = 0\text{V} , \text{Ta} = 25^{\circ}\text{C}$$

Parameter	Symbol	MIN.	MAX.	Unit	Remark
Supply Voltage For Source Driver	AV_{DD}	-0.3	+7.0	V	
	V_{DD}	-0.3	+7.0	V	
Supply Voltage For Gate Driver	V_{CC}	-0.3	+7.0	V	
	$V_{GH}-V_{GL}$	+15	+40	V	
	H Level V_{GH}	-0.3	+45	V	
	L Level V_{GL}	-23	+0.3	V	

8. Electrical Characteristics
8-1) Operating Condition

Parameter	Symbol	MIN.	Typ.	MAX.	Unit	Remark
Supply Voltage For Source Driver	Analog AV_{DD}	+4.5	+5.0	+5.5	V	Depend on T/C signal voltage
	Logic V_{DD}	+3.0	+3.3	+3.6	V	
Supply Voltage For Gate Driver	V_{GH}	+14.5	+15.0	+15.5	V	
	V_{GLDC}	-12.5	-11.0	-9.5	V	DC Component of V_{GL}
	V_{GLAC}	-	+6.0	-	V_{P-P}	AC Component of V_{GL}
	Logic V_{CC}	+3.0	+3.3	+3.6	V	Depend on T/C signal voltage
Analog Signal input Level (VR , VG , VB)	V_{IAC}	-	+3.6	+4.0	V	Note 8-2
	V_{IDC}	-	+2.5	-	V	
Digital input voltage	H level V_{IH}	+0.7Vcc	-	Vcc	V	
	L level V_{IL}	0	-	0.3Vcc	V	
Digital output voltage	H level V_{OH}	Vcc-0.4	-	Vcc	V	
	L level V_{OL}	0	-	0.4	V	
V_{COM}	V_{COMAC}	-	6.0	-	V_{P-P}	AC Component of V_{COM}
	V_{COMDC}	-	1.0	-	V	DC Component of V_{COM} Note 8-1

Note 8-1 : PVI strongly suggests that the V_{COMDC} level shall be adjustable ,and the adjustable level range is $1.0\text{V}\pm 1\text{V}$,every module's V_{COMDC} level shall be carefully adjusted to show a best image performance.

Note 8-2: Both NTSC and PAL system Video Signal input waveform is based on 8 steps gray scale.

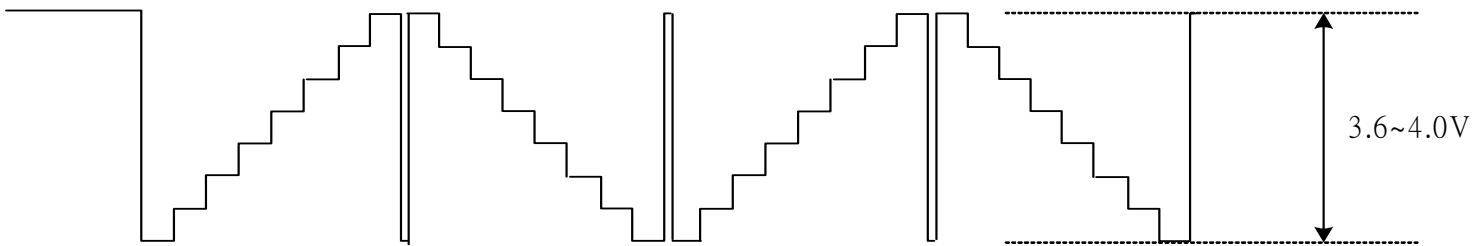

8-2) Current Consumption

Ta = 25°C

Parameter	Symbol	Min.	Typ.	Max.	Unit	Remark
Supply voltage of LED backlight	V _{LED}	-	-	(11.0)	V	Note 8-4
Supply current of LED backlight	I _{LED}	-	20	-	mA	Note 8-5
Backlight Power Consumption	P _{LED}	-	-	0.22	W	Note 8-6

Note 8-4 : I_{LED} = 20mA(Constant Current).

Note 8-5: The LED driving condition is defined for each LED module. (4 LED Serial)

Input current = 20mA * 1 = 20mA

Note 8-6: P_{LED}=V_{LED}* I_{LED}



8-3) Backlight driving & Power Consumption

Ta= 25 °C

Parameter	Symbol	Condition	Min.	Typ.	Max.	Unit	Remark
Current for Driver	I _{GH}	V _{GH} =+15V	-	0.1	0.2	mA	
	I _{GL}	V _{GL} =-12V	-	0.36	0.9	mA	V _{GL} center voltage
	I _{CC}	V _{CC} =+3.3V	-	0.2	0.4	mA	
	A I _{DD}	A V _{DD} =+5V	-	3.5	5.0	mA	
	I _{DD}	V _{DD} =+5V	-	0.6	1.5	mA	
LCD Panel Power Consumption	-	-	-	31.82	57.30	mW	
Backlight power Consumption	P _{LED}	-	-	-	0.22	W	
Total power Consumption	-	-	-	-	0.28	W	

8-4) Input / Output Connector

LCD Module Connector
 FFC Down Connector, 30 Pins
 Pitch : 0.5 mm

8-5) Timing Characteristics Of Input Signals

Characteristics	Symbol	Min.	Typ.	Max.	Unit	Remark
1Field Scanning Period	t1V	-	262.5	-	H	
1Line Scanning Period	t1H	-	63.5	-	μs	
Source Driver Operating Frequency	fhc	1.0	3.14	5.0	MHz	
Signal Sampling Pulse Width	tchw	200	317.7	1000	ns	
Signal Sampling Pulse Delay	tchd	95.3	105.9	116.5	ns	tchd 12,23
Signal Sampling Pulse Width(H)	tchwh	142.9	158.8	174.7	ns	
Signal Sampling Pulse Delay(L)	tchwl	142.9	158.8	174.7	ns	
Source Start Signal Pulse Width	tshw	90	317.7	630*	ns	*tshset=tshhld
Source Start Signal Setup Time	tshset	20	158.8	-	ns	
Source Start Signal Hold Time	tshhld	20	158.8	-	ns	
Source Output Enable Pulse Width	tohw	1.0	2.0	-	μs	
Source Start Signal Rising Time	tss	-	9.8	-	μs	
Video Input Signal Start Point	tvS	-	10.0	-	μs	
Phase Difference Between OEH&CPV	toc	1.5	2.3	-	μs	
Gate Clock Period	tcwv	10	63.5	-	μs	
Gate Clock Pulse Width(H)	tcwh	10	31.7	48	μs	
Gate Clock Pulse Width(L)	tcwl	10	31.7	48	μs	
Gate Start Signal Pulse Width	tsvw	5	63.5	126**	μs	**tsvset=tsvhld
Gate Start Signal Setup Time	tsvset	5	53.2	-	μs	
Gate Start Signal Hold Time	tsvhld	5	10.3	-	μs	
Phase Difference Between OEH&STH	tosp	-	4	-	μs	
Phase Difference Between SYNC&OEH	tohs	-	1.4	-	μs	
Gate Output Enable Pulse Width	toev	-	2.5	-	μs	
V _{COM} Delay Time	t _{DCOM}	-	-	3	μs	
RGB Delay Time	t _{DRGB}	-	-	2	μs	
Vertical Display Start	tsv	-	3	-	tH	

8-6) Signal Timing Waveforms

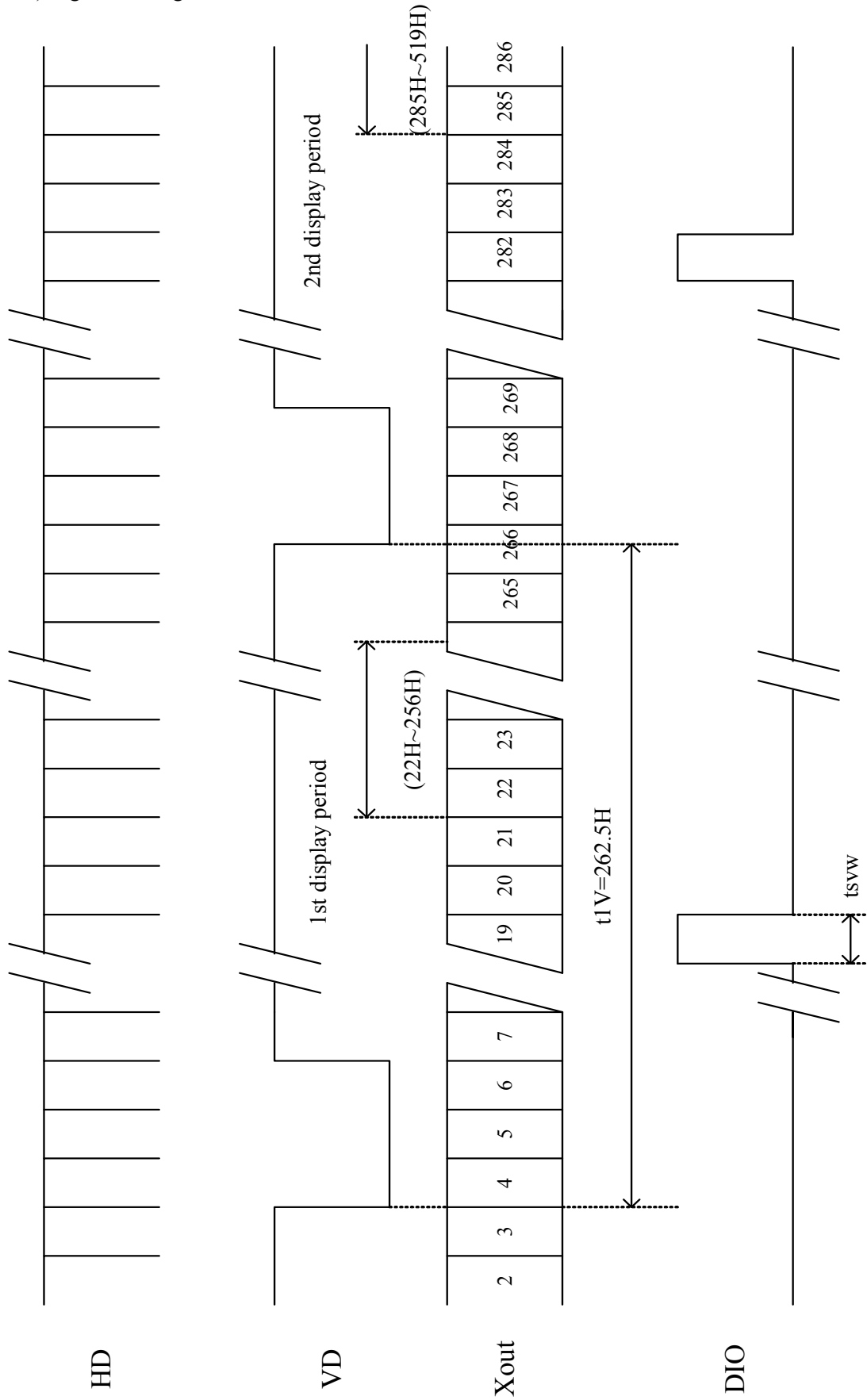
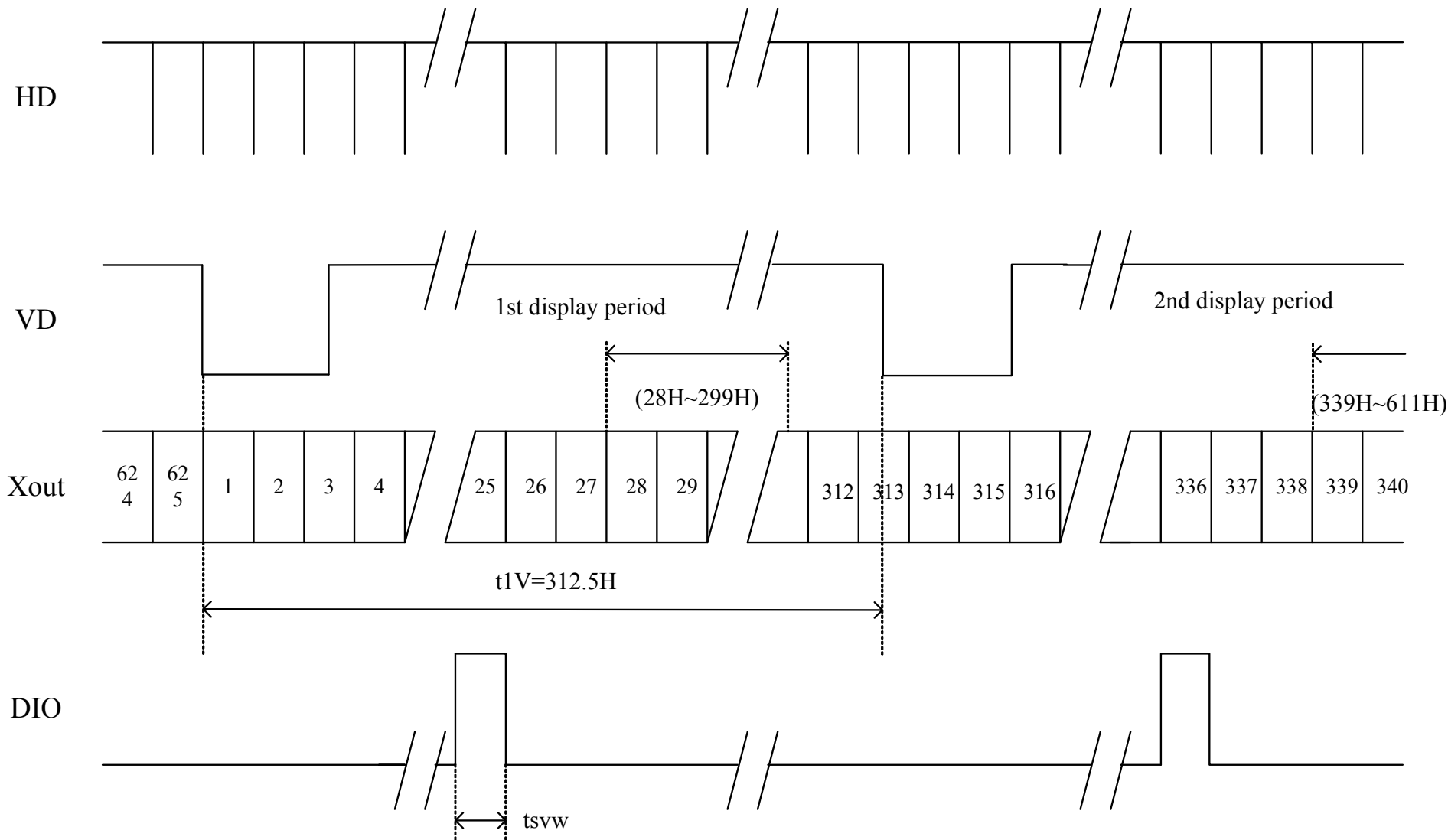

Fig. 8-1 Vertical Start Line for NTSC



** odd field : Scan lines $14n+6$ $14n+12$ ($n = 2, 3, 4..$) are not displayed.
 even field : Scan lines $14n+12$ $14n+20$ ($n = 2, 3, 4..$) are not displayed.

Fig. 8-2 Vertical Start Line for PAL

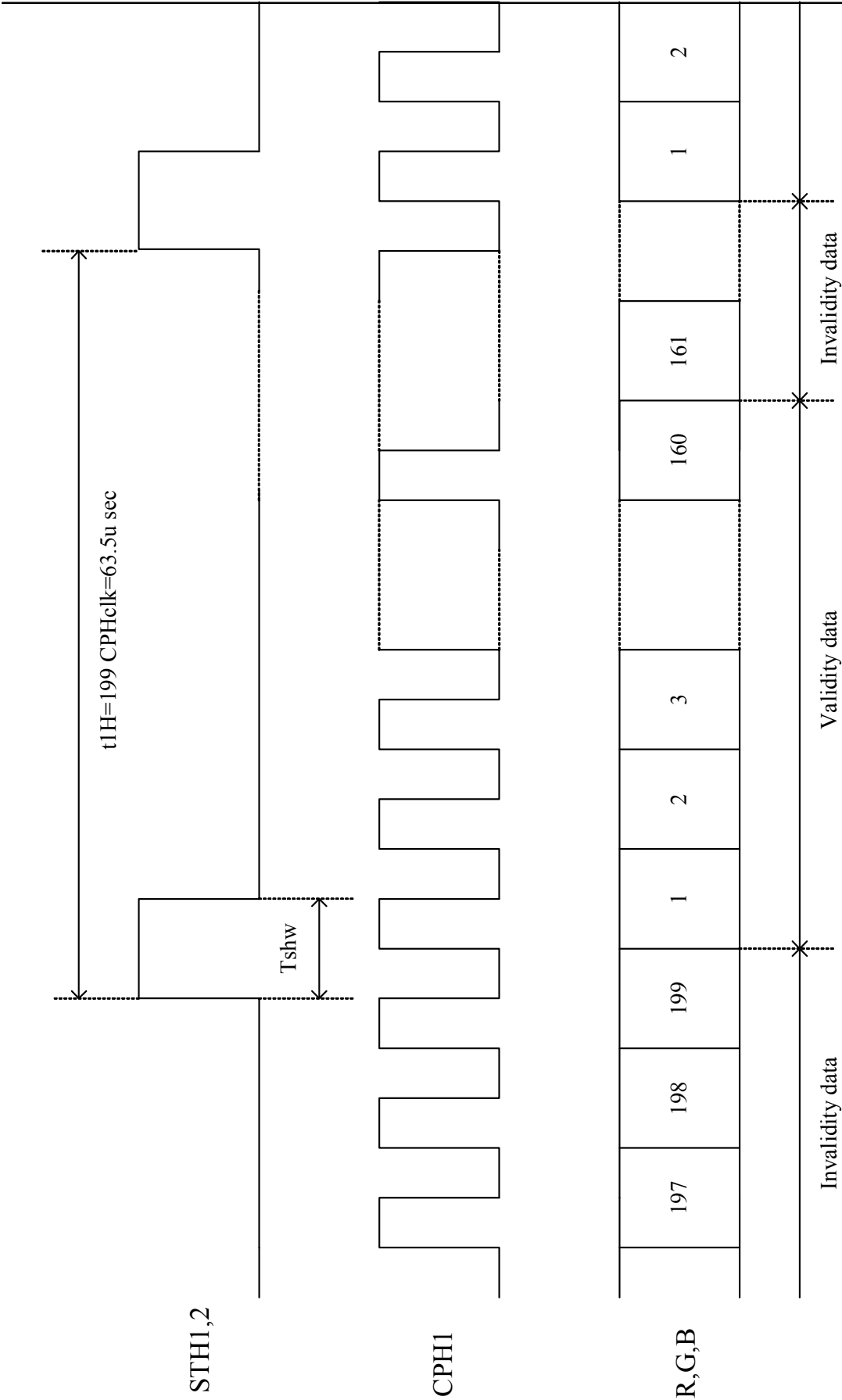

Fig. 8-3 Horizontal Start Pixel

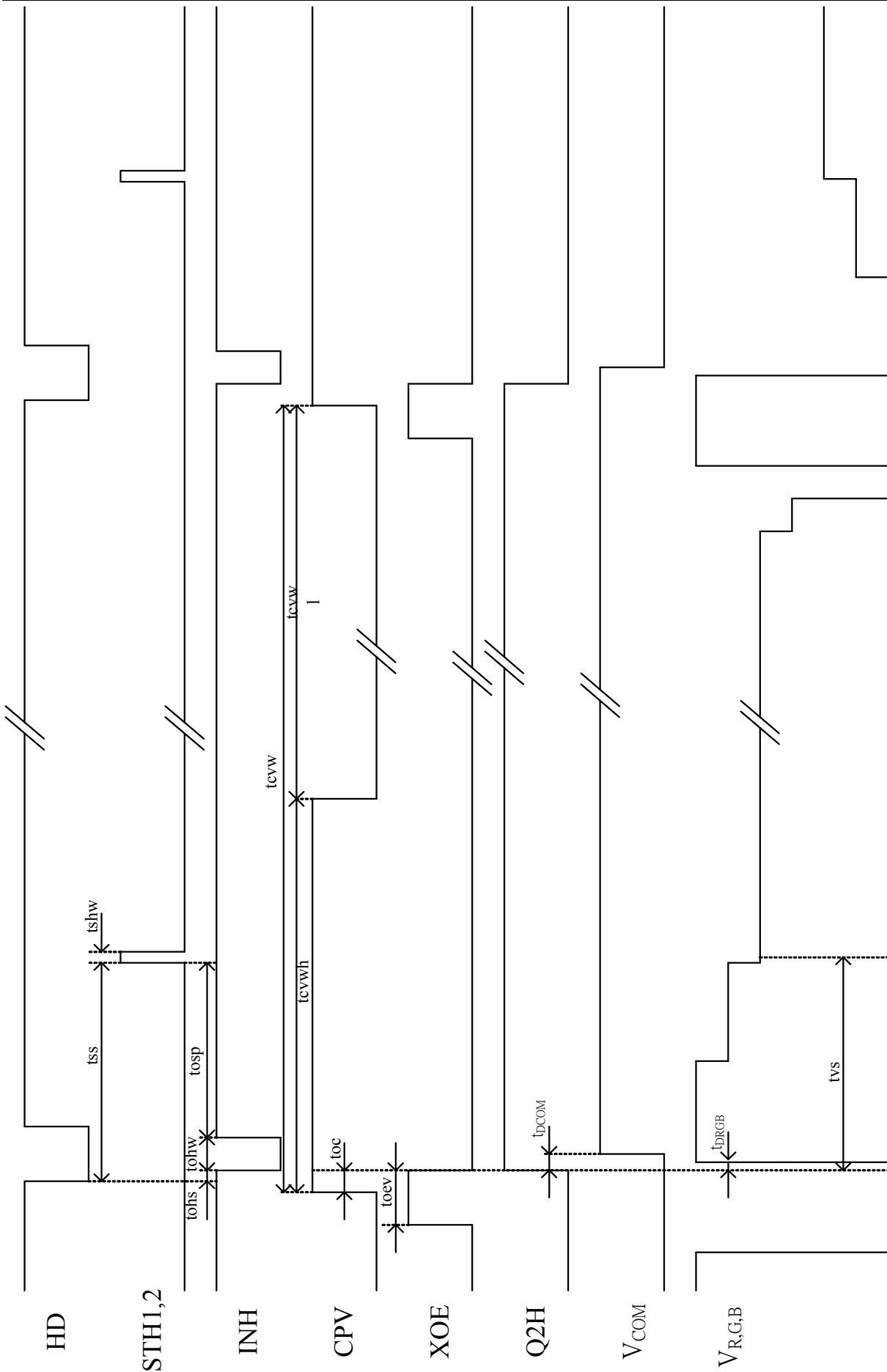

Fig. 8-4 Detail Horizontal Timing

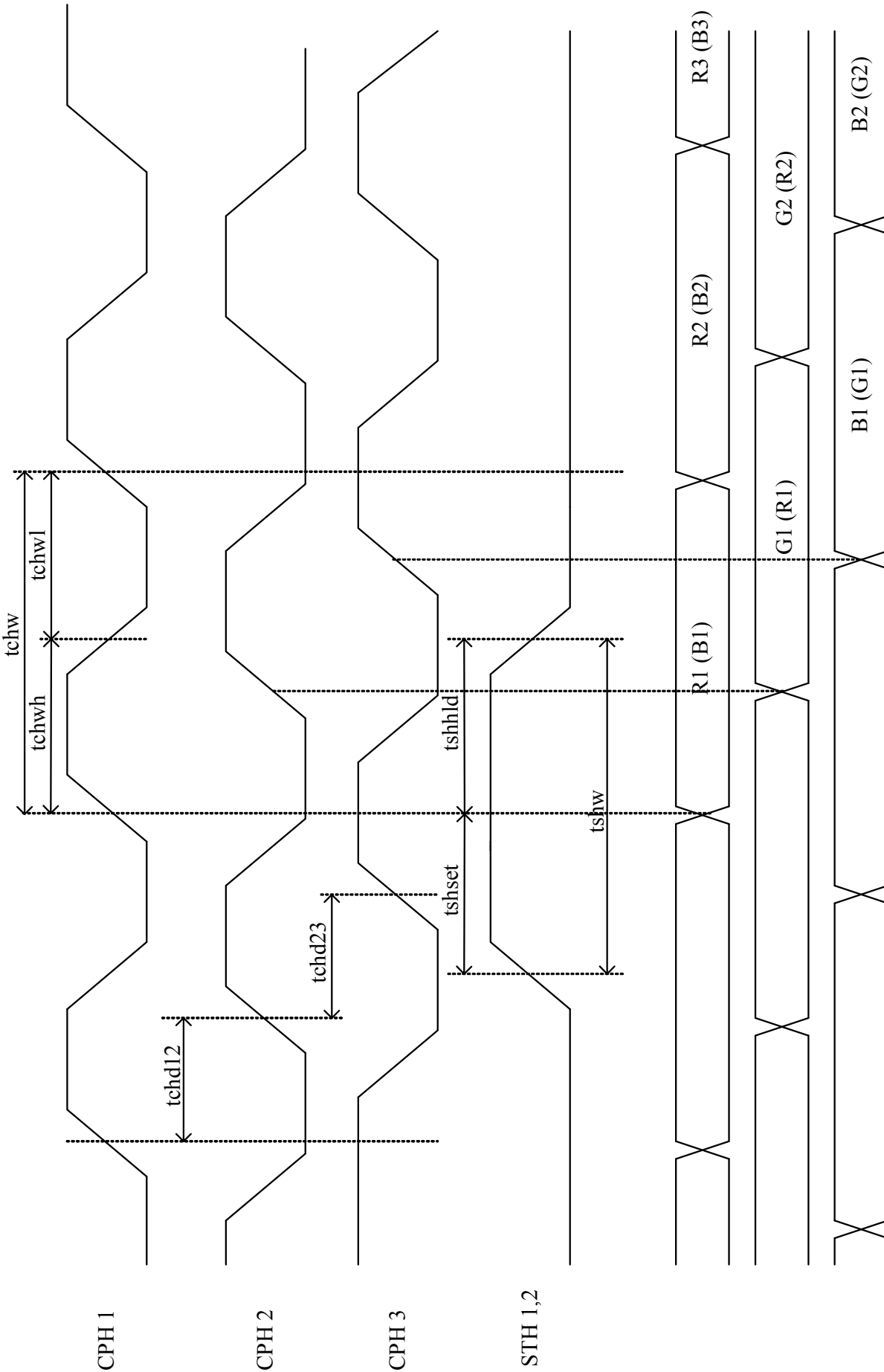

Fig. 8-5 Sampling Clock Timing

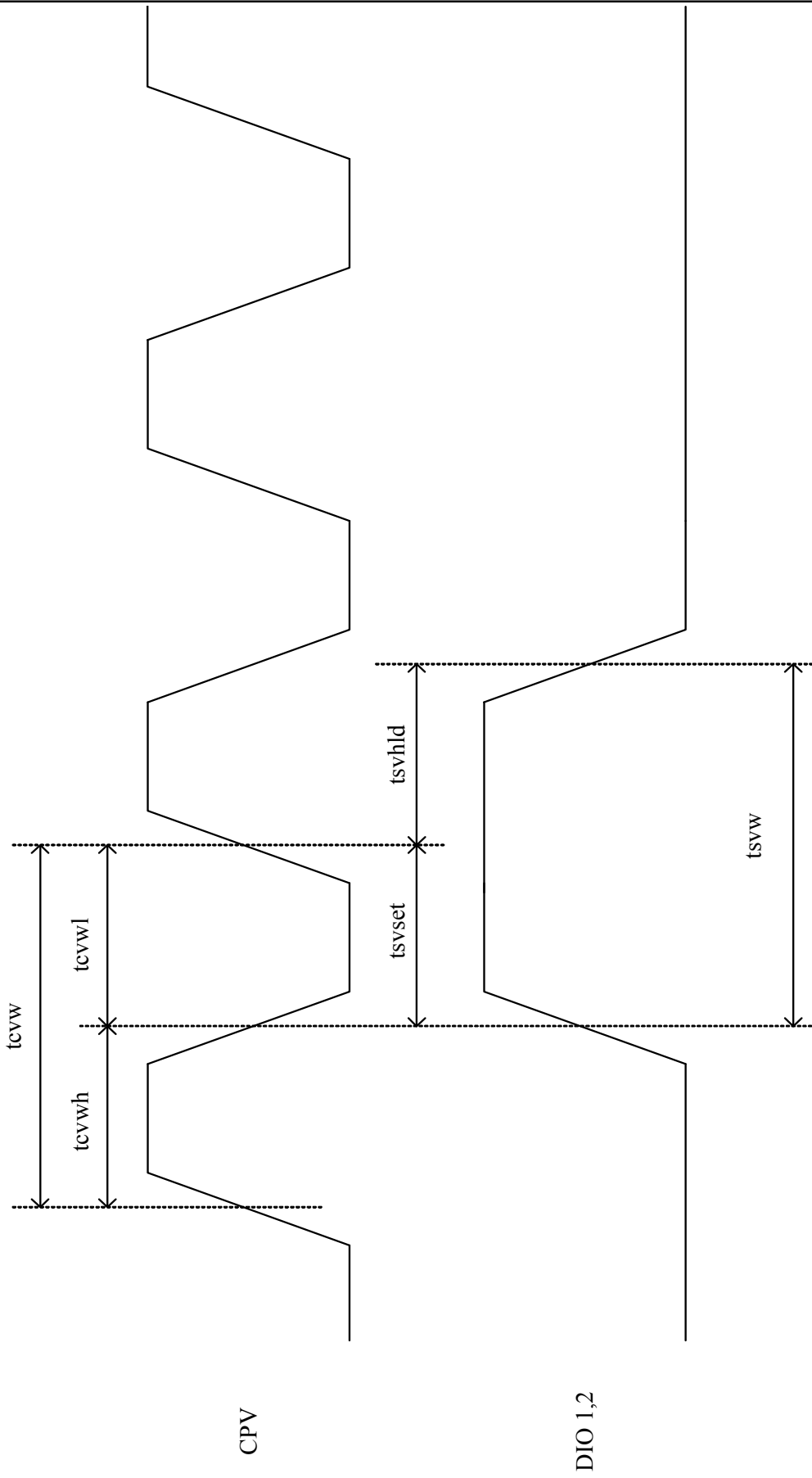

Fig. 8-6 Vertical Shift Clock Timing

Vertical timing (From up to down)

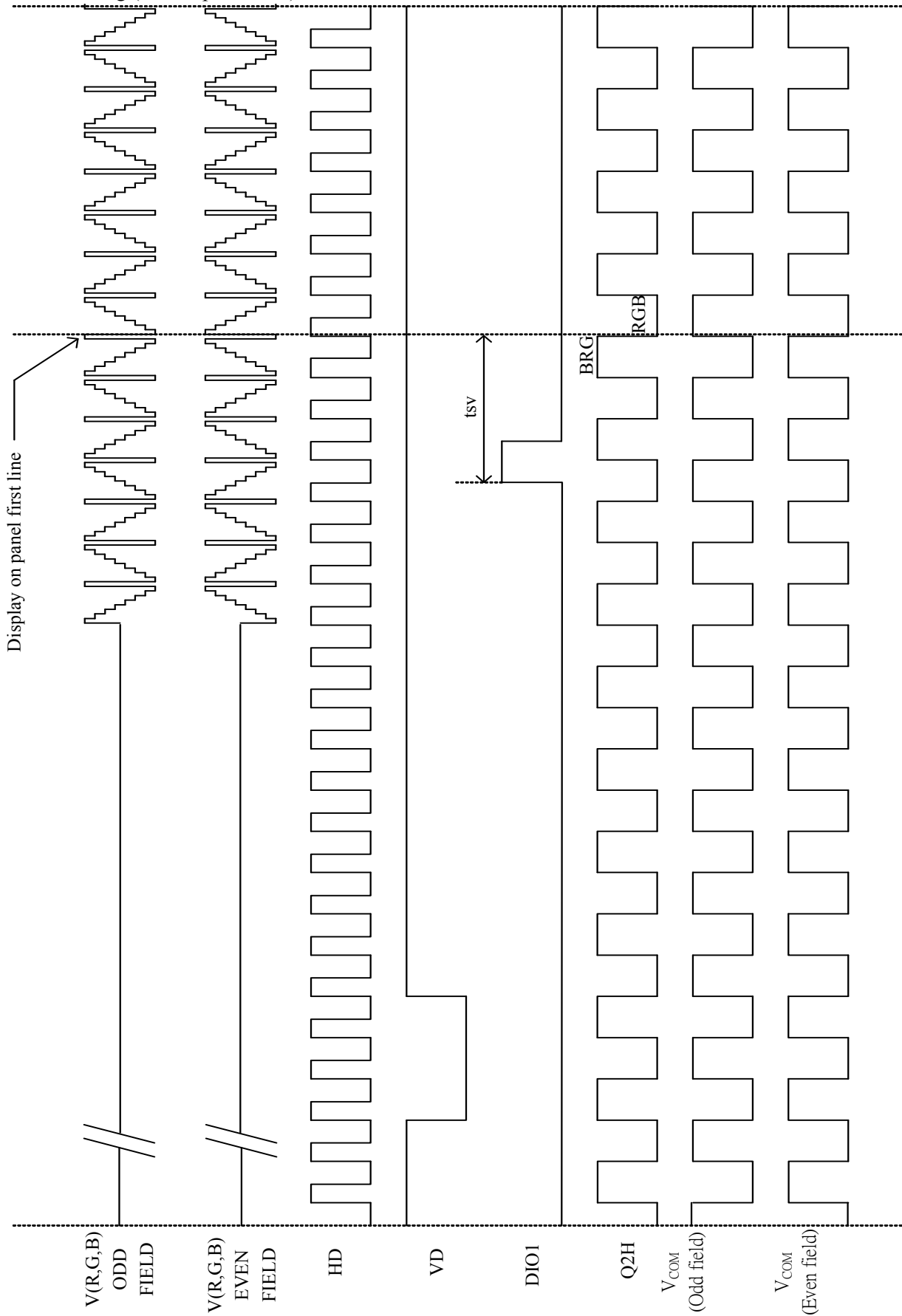

Fig. 8-7(a) Vertical Timing (From Up to Down)

Vertical timing (From down to up)

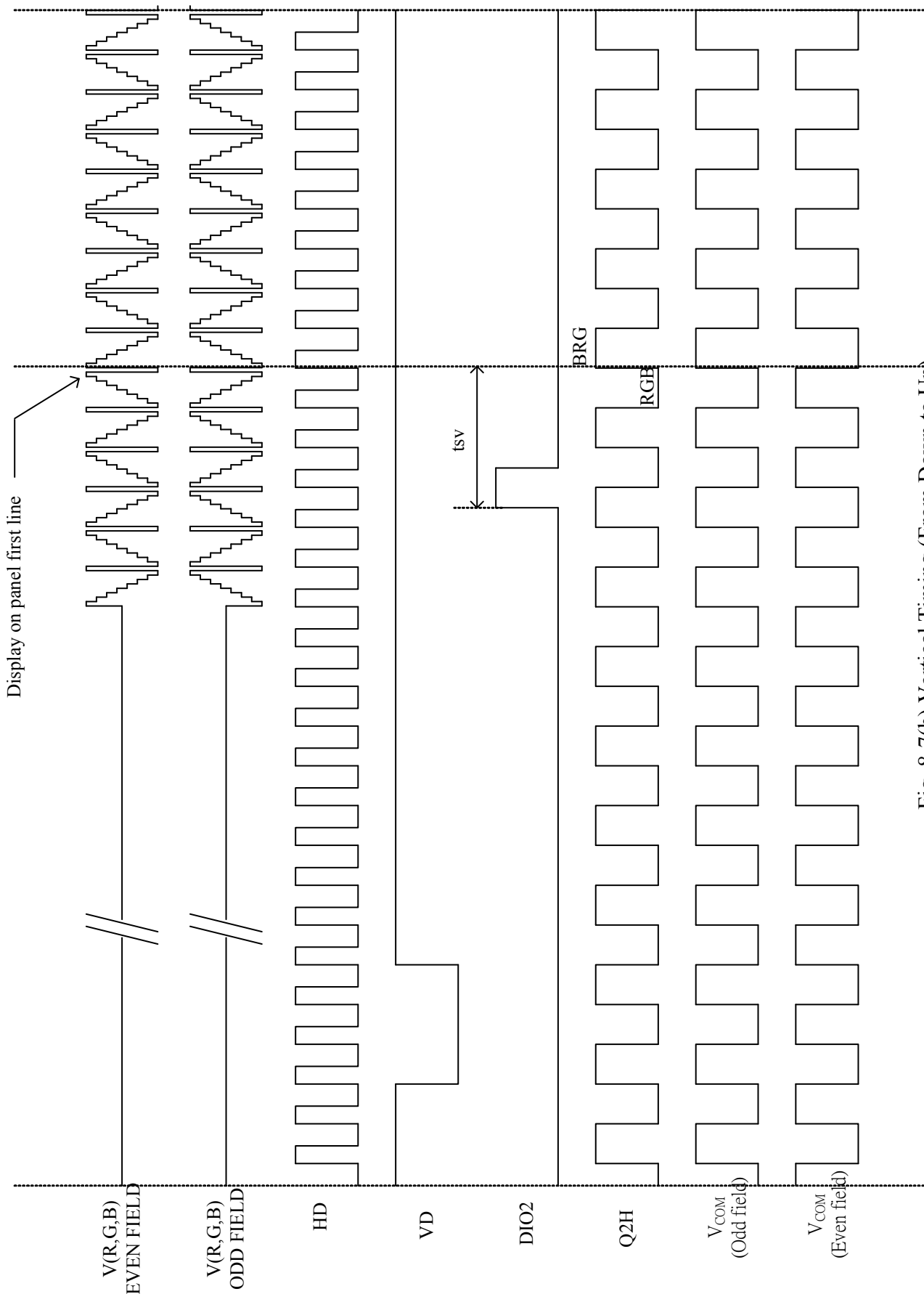
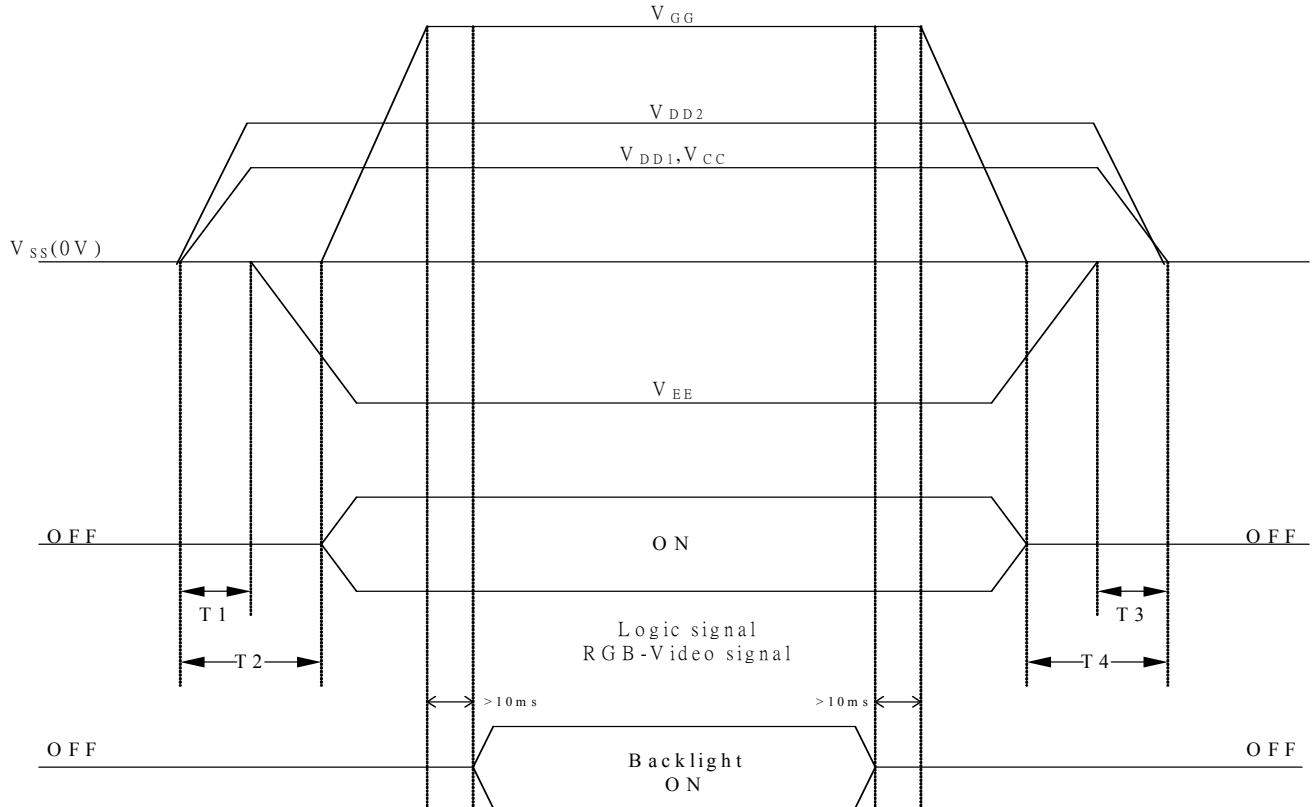

Fig. 8-7(b) Vertical Timing (From Down to Up)

9. Power on Sequence(Voltage source)

The Power on Sequence only effect by $V_{CC}, V_{SS}, V_{DD}, V_{EE}$ and V_{GH} , the others do not care.



- 1) $10ms \leq T1 < T2$
- 2) $0ms < T3 \leq T4 \leq 10ms$

10. Optical Characteristics

10-1) Specification:

$T_a = 25^\circ C$

Parameter	Symbol	Condition	MIN.	TYP.	MAX.	Unit	Remarks	
Viewing Angle	Horizontal	$\theta 21, \theta 22$	± 45	± 50	-	deg	Note 10-1	
	Vertical	$\theta 11$	30	35	-	deg	Note 10-1	
		$\theta 12$	10	15	-	deg	Note 10-1	
Contrast Ratio	CR	At optimized Viewing angle	200	350	-	-	Note 10-2	
Response time	Rise	T_r	-	15	30	ms	Note 10-3	
	Fall	T_f	-	25	50	ms		
Uniformity	U		70	75		%	Note 10-4	
Brightness	L		200	250		cd/m ²		
Chromaticity	White	x	$\theta = 0^\circ$	0.28	0.31	0.34	-	
		y	$\theta = 0^\circ$	0.30	0.33	0.36	-	
LED Life Time		$+25^\circ C$	-	10000	-	hrs	Note 10-5	

All the optical measurement shall be executed 30 minutes after backlight being turn-on. The optical characteristics shall be measured in dark room (ambient illumination on panel surface less than 1 Lux). The measuring configuration shows as following figure.

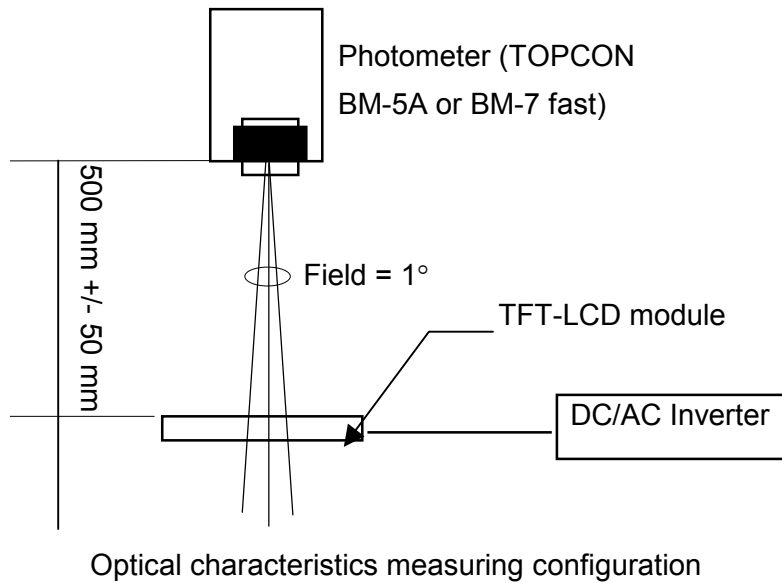

Topcon BM-5A or BM-7 fast luminance meter 1° field of view is used in the testing (after 30 minutes' operation).

Note 10-1 : The definitions of viewing angles

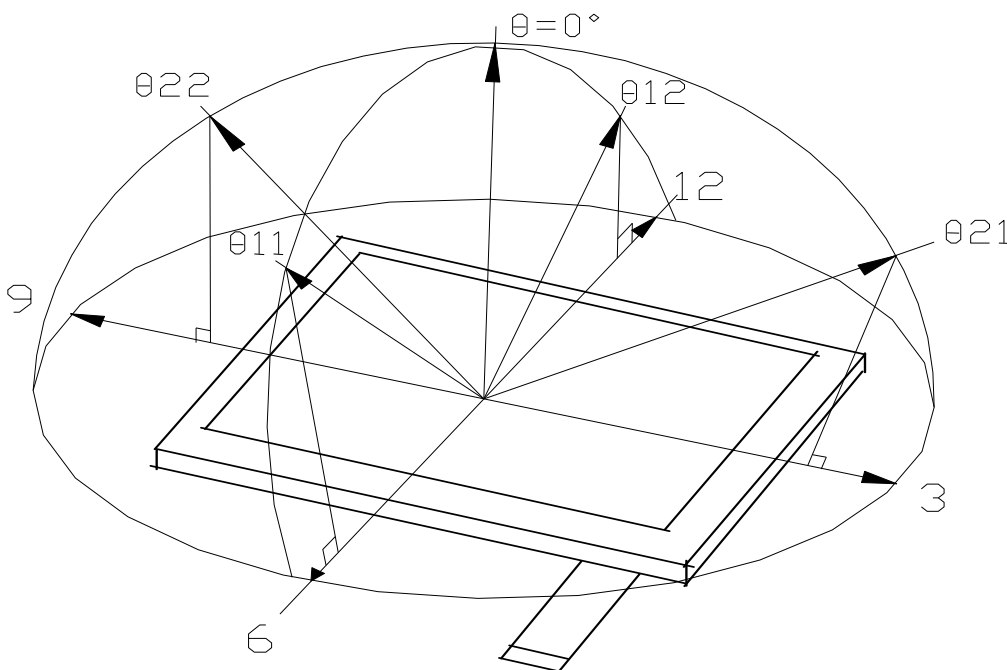

Note 10-2 : CR = $\frac{\text{Luminance when Testing point is White}}{\text{Luminance when Testing point is Black}}$
 (Testing configuration see 10-2)
 Contrast Ratio is measured in optimum common electrode voltage.

Note 10-3 : The definition of response time :

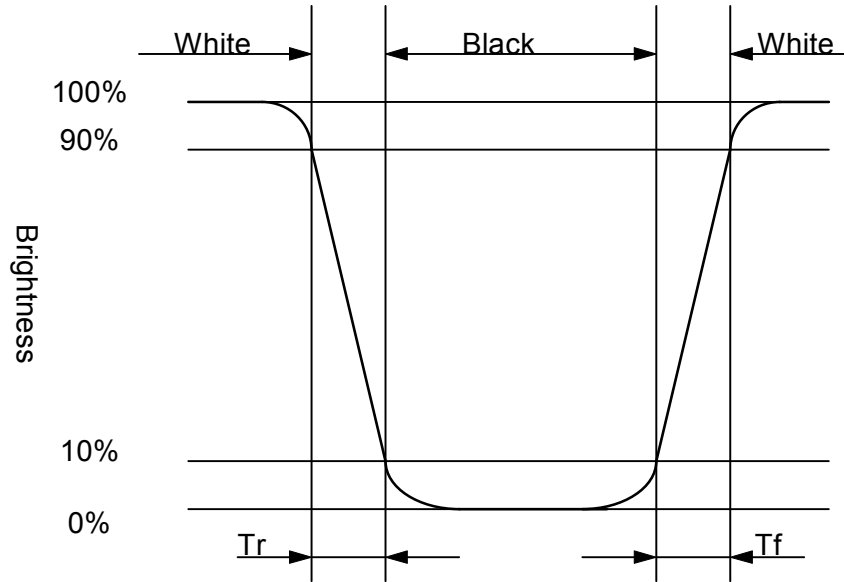

Note 10-4: The uniformity of LCD is defined as

$$U = \frac{\text{The Minimum Brightness of the 9 testing Points}}{\text{The Maximum Brightness of the 9 testing Points}}$$

Luminance meter : BM-5A or BM-7 fast(TOPCON)

Measurement distance : 500 mm +/- 50 mm

Ambient illumination : < 1 Lux

Measuring direction : Perpendicular to the surface of module

The test pattern is white (Gray Level 63).

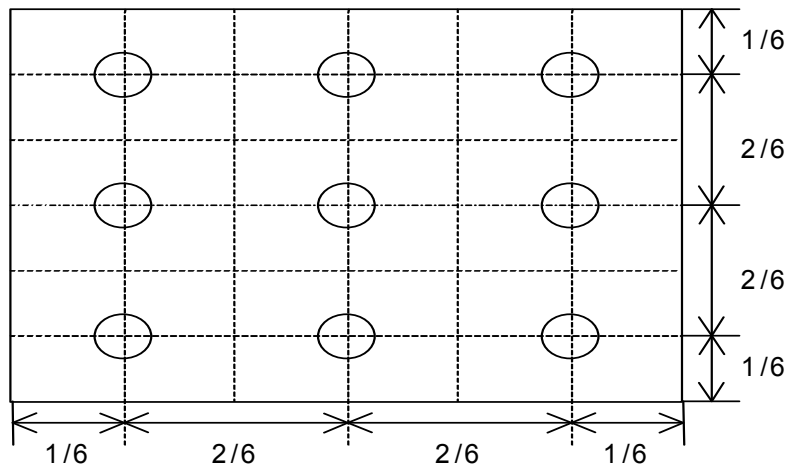

Note 10-5: The “LED Life time “ is defined as the module brightness decrease to 50% original Brightness that the ambient temperature is 25°C and $I_{LED} = 20mA$.

10-2) Testing configuration

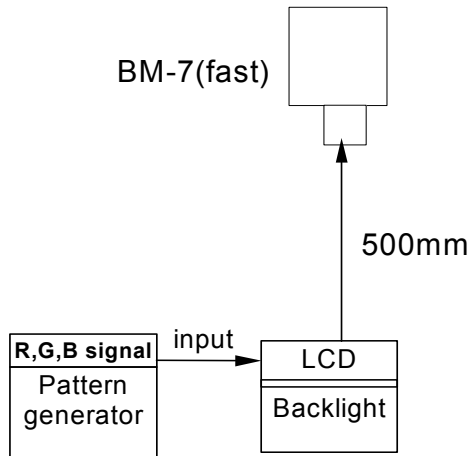

Caution: 1. Environmental illumination ≤ 1 lux
 2. Before test CR, Vcom voltage must be adjusted carefully to get the best CR.

- LCD Display

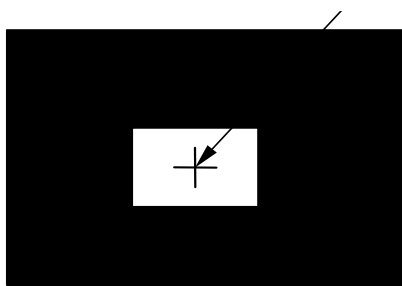

Pattern A

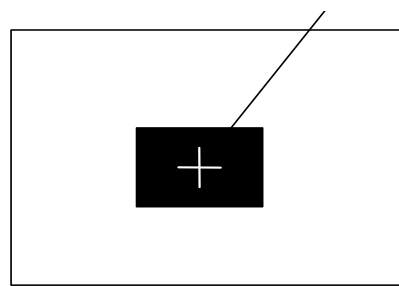

Pattern B

- R, G, B Waveform of Pattern A at Testing Point

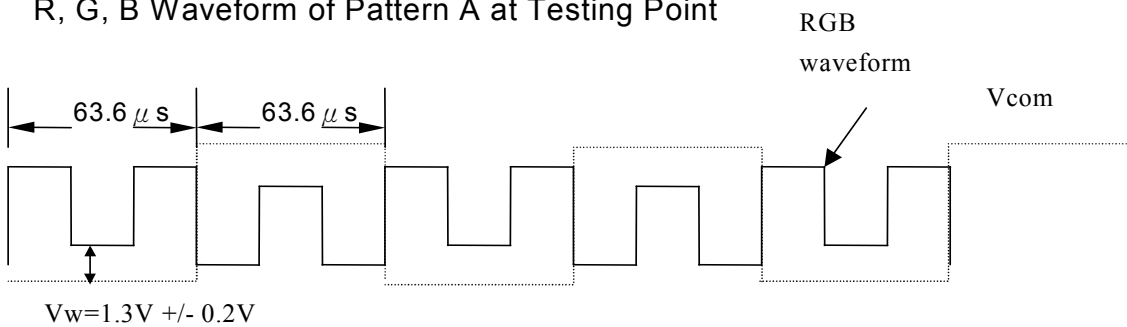

- R, G, B Waveform of Pattern B at Testing Point

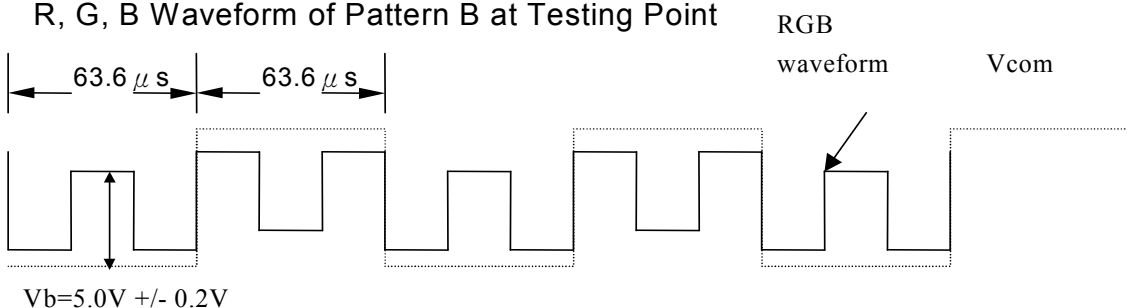

11. Handling Cautions

11-1) Mounting of module

- a) Please power off the module when you connect the input/output connector.
- b) Polarizer which is made of soft material and susceptible to flaw must be handled carefully.
- c) Protective film (Laminator) is applied on surface to protect it against scratches and dirt. It is recommended to peel off the laminator before use and taking care of static electricity.

11-2) Precautions in mounting

- a) When metal part of the TFT-LCD module (shielding lid and rear case) is soiled, wipe it with soft dry cloth.
- b) Wipe off water drops or finger grease immediately. Long contact with water may cause discoloration or spots.
- c) TFT-LCD module uses glass which breaks or cracks easily if dropped or bumped on hard surface. Please handle with care.
- d) Since CMOS LSI is used in the module. So take care of static electricity and earth yourself when handling.

11-3) Adjusting module

- a) Adjusting volumes on the rear face of the module have been set optimally before shipment.
- b) Therefore, do not change any adjusted values. If adjusted values are changed, the specifications described may not be satisfied.

11-4) Others

- a) Do not expose the module to direct sunlight or intensive ultraviolet rays for many hours.
- b) Store the module at a room temperature place.
- c) The voltage of beginning electric discharge may over the normal voltage because of leakage current from approach conductor by to draw lump read lead line around.
- d) If LCD panel breaks, it is possibly that the liquid crystal escapes from the panel. Avoid putting it into eyes or mouth. When liquid crystal sticks on hands, clothes or feet. Wash it out immediately with soap.
- e) Observe all other precautionary requirements in handling general electronic components.
- f) Please adjust the voltage of common electrode as material of attachment by 1 module.

12. Reliability Test

No	Test Item	Test Condition
1	High Temperature Storage Test	Ta = +70°C, 240 hrs
2	Low Temperature Storage Test	Ta = -20°C, 240 hrs
3	High Temperature Operation Test	Ta = 60°C, 240 hrs
4	Low Temperature Operation Test	Ta = 0°C, 240 hrs
5	High Temperature & High Humidity Operation Test	Ta = 60°C, 90%RH, 240 hrs
6	Thermal Cycling Test (non-operating)	-20°C → +70°C, 200 Cycles 30 min 30 min
7	Vibration Test (non-operating)	Frequency : 10 ~ 55 Hz Amplitude : 1.5 mm Sweep time: 11 mins Test Period : 6 Cycles for each direction of X, Y, Z
8	Shock Test (non-operating)	100G, 6ms Direction : ±X, ±Y, ±Z Cycle : 3 times
9	Electrostatic Discharge Test (non-operating)	200pF, 0Ω ±200V 1 time / each terminal

Ta: ambient temperature

Note : The protective film must be removed before temperature test.

[Criteria]

In the standard conditions, there is not display function NG issue occurred. (including : line defect ,no image).All the cosmetic specification is judged before the reliability stress.

13. Block Diagram

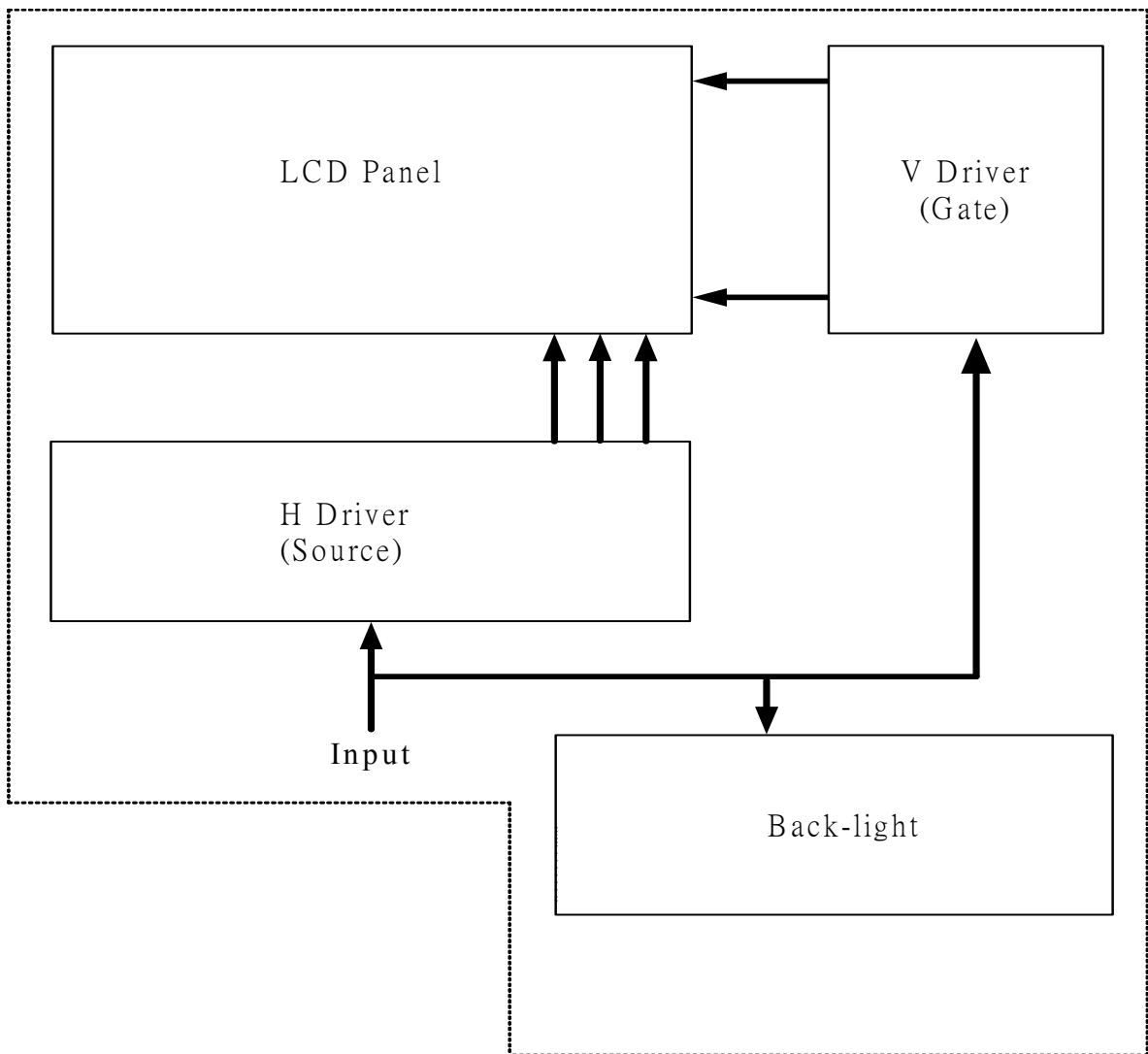

14. Packing

REV.	DESCRIPTION	DESIGN	DATE
⚠	Cancel the carton(50-0100101)	Ethan	2007.11.5

NOTE:

1. One layer include: 1 piece of cushion sheet, 16 pcs panel & 1 piece of tray.
2. Q'TY: 160 pcs panel/carton.
3. Dimension: 455*375*190mm
4. Weight: 5.5 KG
5. tray高180*交叉堆疊, 堆疊後可從側邊檢視圓弧防呆方向是否正確

ITEM	PART NO.	DESCRIPTION	QTY	REMARK
6	50-0100091	CARTON INTERNAL	1	
5	50-0500041	摺口袋450*380*700mm	1	抗靜電
4		PA025XSC	160	
3	50-0200058	EPE CUSHION SHEET	10	抗靜電
2	50-0300992	TRAY	11	抗靜電
1	50-0300491	EPE FOAM	2	

MTL.SPEC.		UNSPECIFIED TOL'S		REMARK	
		ANGLE			
		ROUGHNESS			
APPROVE	Frank Shin	'05.06.06	SCALE	UNIT	SHEET
CHECK	Frank Shin	'05.06.06	1:1	mm	1 OF 1
DESIGN	Dennis	'05.06.06	MTL.NO.		DWG.NO.

元太科技股份有限公司
Prime View International Co.,Ltd.

DWG.TITLE
PA025XSC PACKING Dim

REV.	01	A	4	SIZE
------	----	---	---	------

Appendix

