



*Document Version: 1.4*

*Date: 2006/2/28*

## **Product Specifications**

**26.0" WXGA Color TFT-LCD Module**  
**Model Name: T260XW02 V4**

**( ) Preliminary Specifications**

**(\* ) Final Specifications**



## Contents

No	ITEM
	COVER
	CONTENTS
	RECORD OF REVISIONS
<b>1</b>	GENERAL DESCRIPTION
<b>2</b>	ABSOLUTION MAXIMUM RATINGS
<b>3</b>	ELECTRICAL SPECIFICATIONS
<b>3-1</b>	ELECTRICAL CHARACTERISTICS
<b>3-2</b>	INTERFACE CONNECTIONS
<b>3-3</b>	SIGNAL TIMING SPECIFICATIONS
<b>3-4</b>	SIGNAL TIMING WAVEFORMS
<b>3-5</b>	COLOR INPUT DATA REFERENCE
<b>3-6</b>	POWER SEQUENCE
<b>4</b>	OPTICAL SPECIFICATIONS
<b>5</b>	MECHANICAL CHARACTERISTICS
<b>6</b>	RELIABILITY
<b>7</b>	INTERNATIONAL STANDARDS
<b>7-1</b>	SAFETY
<b>7-2</b>	EMC
<b>8</b>	PACKING
<b>9</b>	PRECAUTIONS



## Record of Revision

Version	Date	No	Old Description	New Description	Remark
1.0	7/12 '05		Original version		
1.1	10/11 '05		First release		
1.2	12/15 '05		Timing update		
1.3	1/17 '06			Modify inverter mylar shielding screw hole portion	p.20~21
1.4	2/28 '06		Timing table	Add recommend maximum rating	p.11



## 1. General Description

This specification applies to the 26.0 inch Color TFT-LCD Module T260XW02. This LCD module has a TFT active matrix type liquid crystal panel 1366x768 pixels, and diagonal size of 26.0 inch. This module supports 1366x768 XGA-WIDE mode (Non-interlace).

Each pixel is divided into Red, Green and Blue sub-pixels or dots which are arranged in vertical stripes. Gray scale or the brightness of the sub-pixel color is determined with a 8-bit gray scale signal for each dot.

The T260XW02 has been designed to apply the 8-bit 1 channel LVDS interface method. It is intended to support displays where high brightness, wide viewing angle, high color saturation, and high color depth are very important.

### \* General Information

Items	Specification	Unit	Note
Active Screen Size	26.0	inches	
Display Area	575.769 (H) x 323.712(V)	mm	
Pixel Pitch	0.4215	mm	
Outline Dimension	626.0 (H) x 373.0 (V) x 43.3(D)	mm	With inverter
Driver Element	a-Si TFT active matrix		
Display Colors	16.7M	Colors	
Number of Pixels	1366 x 768	Pixel	
Pixel Arrangement	RGB vertical stripe		
Display Mode	Normally Black		
BL Structure	8 U-Lamps		
Surface Treatment	AG, 3H		



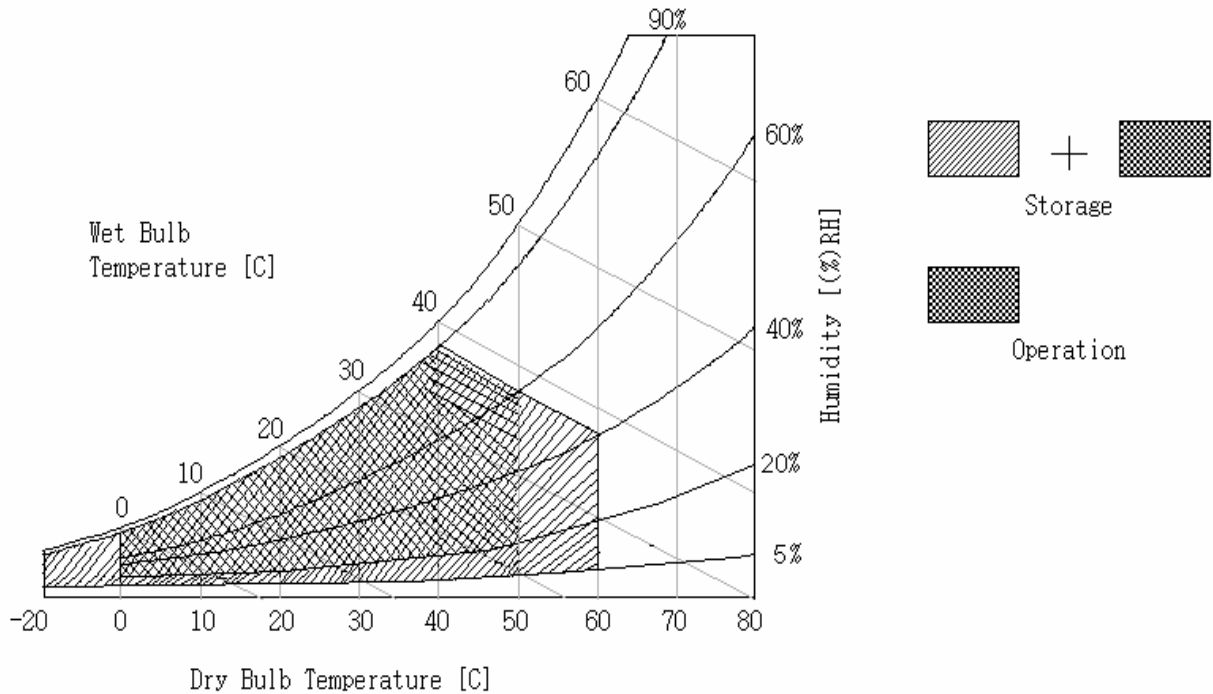
## 2. Absolute Maximum Ratings

The following are maximum values which, if exceeded, may cause faulty operation or damage to the unit.

Item	Symbol	Min	Max	Unit	Conditions
Logic/LCD Drive Voltage	VDD	-0.3	13.2	[Volt]	Note 1
Input Voltage of Signal	Vin	-0.3	3.6	[Volt]	Note 1
BLU Input Voltage	VDDDB	-0.3	27.0	[Volt]	Note 1
BLU Brightness Control Voltage	BLON	-0.3	6.0	[Volt]	Note 1
Operating Temperature	TOP	0	+50	[°C]	Note 2
Operating Humidity	HOP	10	90	[%RH]	Note 2
Storage Temperature	TST	-20	+60	[°C]	Note 2
Storage Humidity	HST	10	90	[%RH]	Note 2

Note 1 : Duration = 50msec

Note 2 : Maximum Wet-Bulb should be 39°C and No condensation.





### 3. Electrical Specification

The T260XW02 requires two power inputs. One is employed to power the LCD electronics and to drive the TFT array and liquid crystal. The second input power for the BLU, is to power inverter..

#### 3-1 Electrical Characteristics

Parameter	Symbol	Values			Unit	Notes
		Min.	Typ.	Max.		
<b>LCD:</b>						
<b>Power Supply Input Voltage</b>	V <sub>CC</sub>	10.8	12.0	13.2	V <sub>DC</sub>	
<b>Power Supply Input Current</b>	I <sub>CC</sub>	-	583	682	mA	1
<b>Power Consumption</b>	P <sub>c</sub>	-	7.0	9.0	Watt	1
<b>Inrush Current</b>	I <sub>RUSH</sub>	-	-	3.0	A <sub>peak</sub>	2
<b>Backlight Power Consumption</b>			72	81.6	Watt	
<b>Life Time</b>		50,000	60,000		Hours	3

**Note :**

1. V<sub>CC</sub>=12.0V,  $f_v = 60\text{Hz}$ ,  $f_{CLK} = 81.0\text{ MHz}$ , 25°C.
2. Duration = 470 ms
3. The performance of the Lamp in LCM, for example: lifetime or brightness, is extremely influenced by the characteristics of the DC-AC Inverter. So all the parameters of an inverter should be carefully designed so as not to produce too much leakage current from high-voltage output of the inverter. When you design or order the inverter, please make sure unwanted lighting caused by the mismatch of the lamp and the inverter (no lighting, flicker, etc) never occurs. When you confirm it, the LCD Assembly should be operated in the same condition as installed in your instrument.
4. Do not attach a conducting tape to lamp connecting wire. If the lamp wire attach to conducting tape, TFT-LCD Module have a low luminance and the inverter has abnormal action because leakage current occurs between lamp wire and conducting tape.
5. The relative humidity must not exceed 80% non-condensing at temperatures of 40°C or less. At temperatures greater than 40°C, the wet bulb temperature must not exceed 39°C. When operate at low temperatures, the brightness of CCFL will drop and the lifetime of CCFL will be reduced.



### 3-2 Interface Connections

- LCD connector (CN1): FI-X30SSL-HF (JAE) or equivalent
- Mating Connector: FI-X30H (JAE), FI-X30HL (JAE-Lock type) or equivalent
- LVDS Transmitter: SN75LVDS83(Texas Instruments) or equivalent

**Note:**

1. All GND (ground) pins should be connected together and should also be connected to the LCD's metal frame. All Vcc (power input) pins should be connected together.

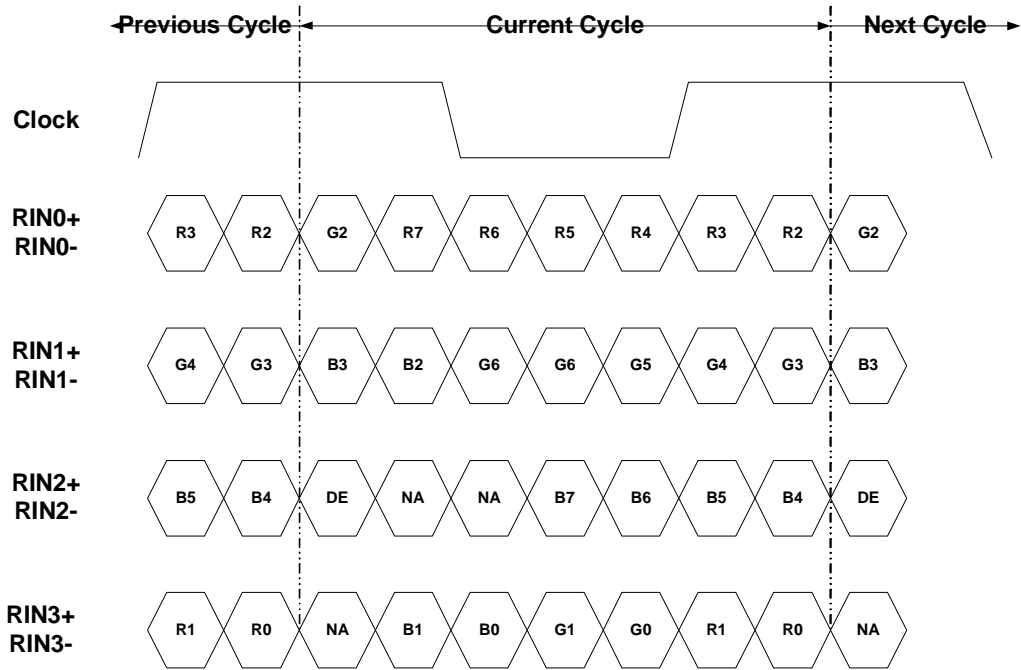
Pin No	Symbol	Description	Default
1	VCC	+12V, DC, Regulated	
2	VCC	+12V, DC, Regulated	
3	VCC	+12V, DC, Regulated	
4	VCC	+12V, DC, Regulated	
5	GND	Ground and Signal Return	
6	GND	Ground and Signal Return	
7	GND	Ground and Signal Return	
8	GND	Ground and Signal Return	
9	LVDS Option	Low/Open for Normal (NS), High for JEIDA	Option
10	Reserved	Open or High	AUO internal test
11	GND	Ground and Signal Return for LVDS	
12	RXIN0-	LVDS Channel 0 negative	
13	RXIN0+	LVDS Channel 0 positive	
14	GND	Ground and Signal Return for LVDS	
15	RXIN1-	LVDS Channel 1 negative	
16	RXIN1+	LVDS Channel 1 positive	
17	GND	Ground and Signal Return for LVDS	
18	RXIN2-	LVDS Channel 2 negative	
19	RXIN2+	LVDS Channel 2 positive	
20	GND	Ground and Signal Return for LVDS	
21	RXCLKIN-	LVDS Clock negative	
22	RXCLKIN+	LVDS Clock positive	
23	GND	Ground and Signal Return for LVDS	
24	RXIN3-	LVDS Channel 3 negative	
25	RXIN3+	LVDS Channel 3 positive	
26	GND	Ground and Signal Return for LVDS	
27	Reserved	Open or High	AUO internal test
28	Reserved	Open or High	AUO internal test
29	GND	Ground and Signal Return	
30	GND	Ground and Signal Return	

**\*\* LVDS Option : Low/Open è NS (Normal)**

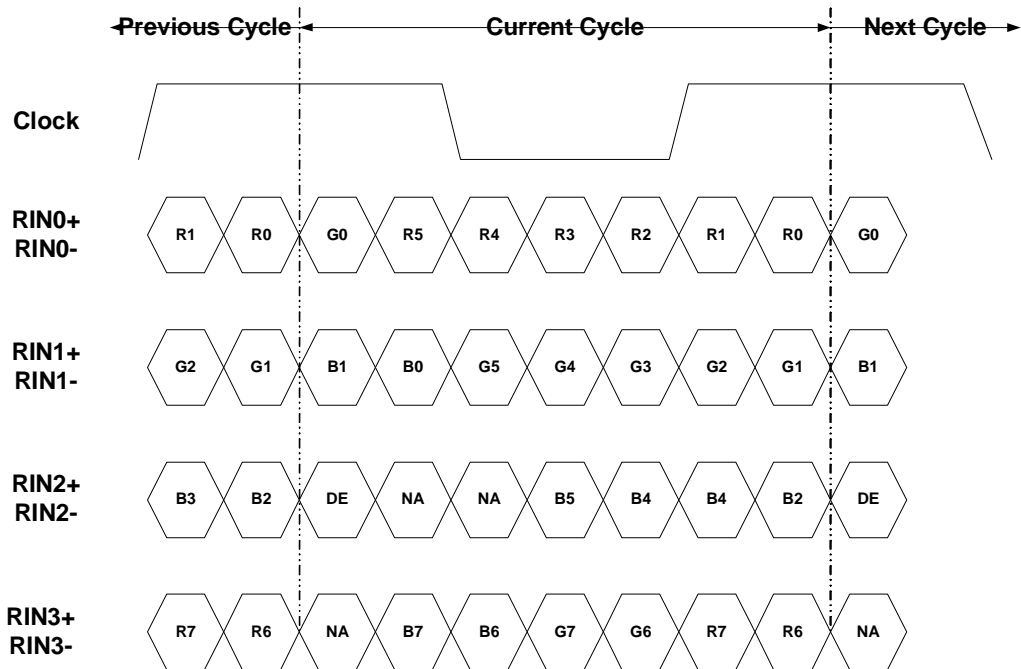
**High (3.3V) è JEIDA**



**LVDS Option = H (3.3V) è JEIDA**



**LVDS Option = GND or OPEN è NS**







## BACKLIGHT CONNECTOR PIN CONFIGURATION

### 1. Electrical specification

(Ta=25±5°C)

No	ITEM	SYMBOL	CONDITION	MIN	TYP	MAX	UNIT	Note	
1	Input Voltage	V <sub>DDB</sub>	---	21.6	24.0	26.4	V <sub>DC</sub>		
2	Input Current	I <sub>DDB</sub>	V <sub>DDB</sub> =24V Max. Brightness	---	3.0	3.4	A <sub>DC</sub>	V <sub>DIM</sub> : Open	
3	Input Power	P <sub>DDB</sub>	V <sub>DDB</sub> =24V Dimming Max.	---	72	81.6	W	V <sub>DIM</sub> : Open	
4	Input inrush current, 0.3ms	I <sub>RUSH</sub>	V <sub>DDB</sub> =24V Dimming Max.	---	---	3.4	A <sub>DC</sub>	V <sub>DIM</sub> : Open	
5	Output Frequency	F <sub>BL</sub>	V <sub>DDB</sub> =24V	---	58	---	kHz		
6	ON/OFF Control Voltage	V <sub>BLON</sub>	ON	V <sub>DDB</sub> =24V	2.0	3.3	5.0	V <sub>DC</sub>	or Open
			OFF	V <sub>DDB</sub> =24V	0.0	---	0.8	V <sub>DC</sub>	
7	ON/OFF Control Current	I <sub>BLON</sub>	V <sub>DDB</sub> =24V	-1	---	1.5	mA <sub>DC</sub>		
8	External PWM Control Voltage	EV <sub>PWM</sub>	MAX	---	2.0	3.3	5.0	V <sub>DC</sub>	or Open
			MIN	---	-0.3	---	0.8	V <sub>DC</sub>	
9	External PWM Control Current	EI <sub>PWM</sub>	MAX	PWM=100%	0.5	---	---	mA <sub>DC</sub>	
			MIN	PWM=100%	0.5	---	---	mA <sub>DC</sub>	
10	External PWM Duty Ratio	ED <sub>PWM</sub>	---	30	---	100	%		
11	External PWM Frequency	EF <sub>PWM</sub>	---	120	180	300	Hz		

### 2. Input specification

CN1: S14B-PH-SM3-TB(JST) or Compatible

CN2: S2B-ZR-SM3A-TF(JST) or Compatible


CN3~10: SM02(12)B-BHS-1-TB(JST) or Compatible

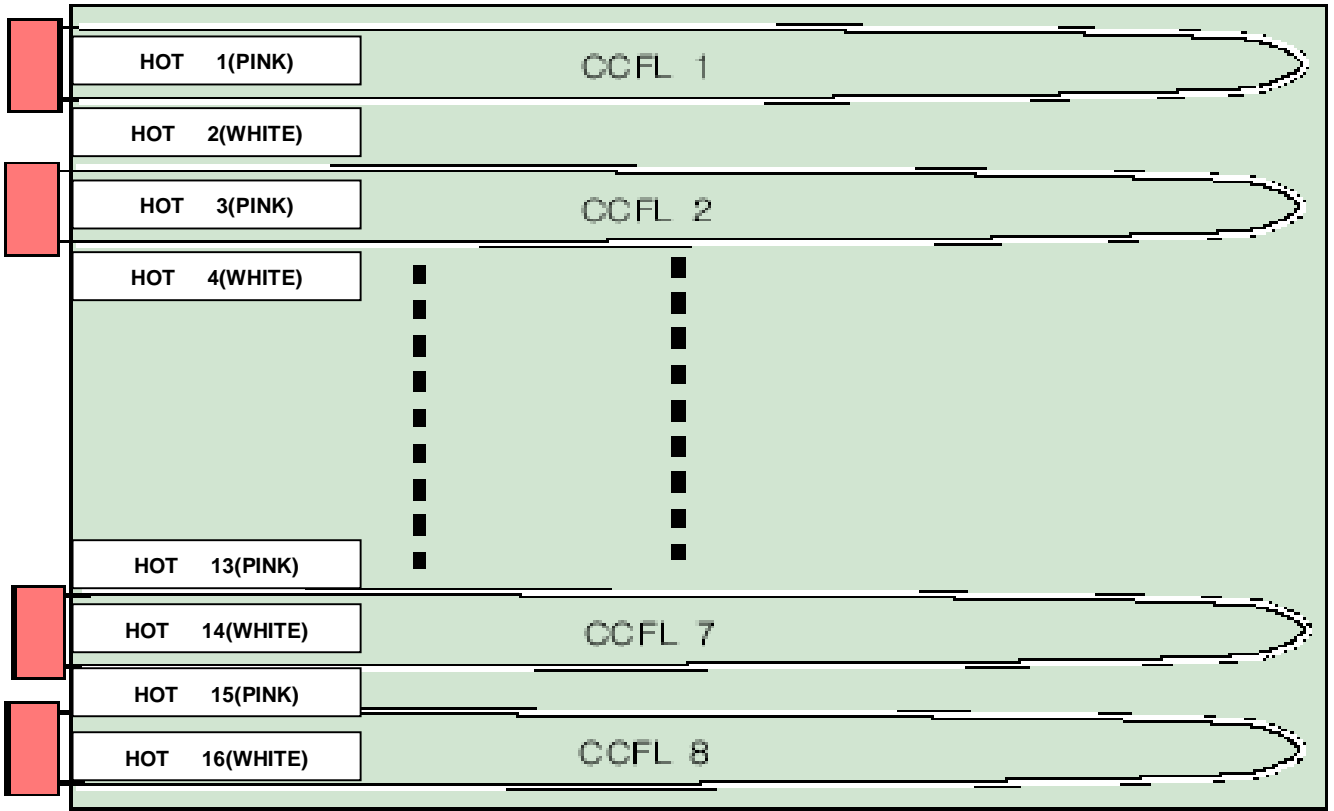
Pin No	Symbol	Description	Default
1	VIN	Operating Voltage Supply, +24V DC regulated	24V
2	VIN	Operating Voltage Supply, +24V DC regulated	24V
3	VIN	Operating Voltage Supply, +24V DC regulated	24V
4	VIN	Operating Voltage Supply, +24V DC regulated	24V
5	VIN	Operating Voltage Supply, +24V DC regulated	24V
6	GND	Ground	GND
7	GND	Ground	GND
8	GND	Ground	GND
9	GND	Ground	GND
10	GND	Ground	GND
11	Reserved	N.C.*	-
12	BL ON/OFF	On/Off Control	-
13	PWM DIM	External PWM Dimming Control	-
14	Reserved	N.C.**	-

\*: Pin11 and Pin14 are floating

\*\* : Pin14 setting can use GND or 3.3V and w/o any function problem

### 3. Backlight Diagram

 **HOT: High Voltage**





### 3-3 Signal Timing Specifications

This is the signal timing required at the input of the User connector. All of the interface signal timing should be satisfied with the following specifications for its proper operation.

\* Timing Table

DE only Mode

Signal	Item	Symbol	Function ok			Recommend for Waterfall		Unit
			Min	Type	Max	50Hz	60Hz	
Vertical Section	Period	Tv	784	—	1015	789~822	789~822	Th
	Active	Tdisp (v)	768			768		Th
	Blanking	Tblk (v)	16	—	247	21~54	21~54	Th
Horizontal Section	Period	Th	1414	—	2000	1414~1722	1414~1722	Tclk
	Active	Tdisp (h)	1366			1366		Tclk
	Blanking	Tblk (h)	48	—	634	48~356	48~356	Tclk
Clock	Period	CLK		—			18.18	ns
	Frequency	Freq	55	—	88	55~88	55~88	MHz
Vertical Frequency	Frequency	Vs	44		66	48~52	58~62	Hz
Horizontal Frequency	Frequency	Hs	39.45		53	39.45~41.1	47.34~49.32	KHz

\*1) DCLK signal input must be valid while power supply is applied.

\*2) Display position is specific by the rise of DE signal only.

Horizontal display position is specified by the falling edge of 1<sup>st</sup> DCLK right after the rise of DE, is displayed on the left edge of the screen.

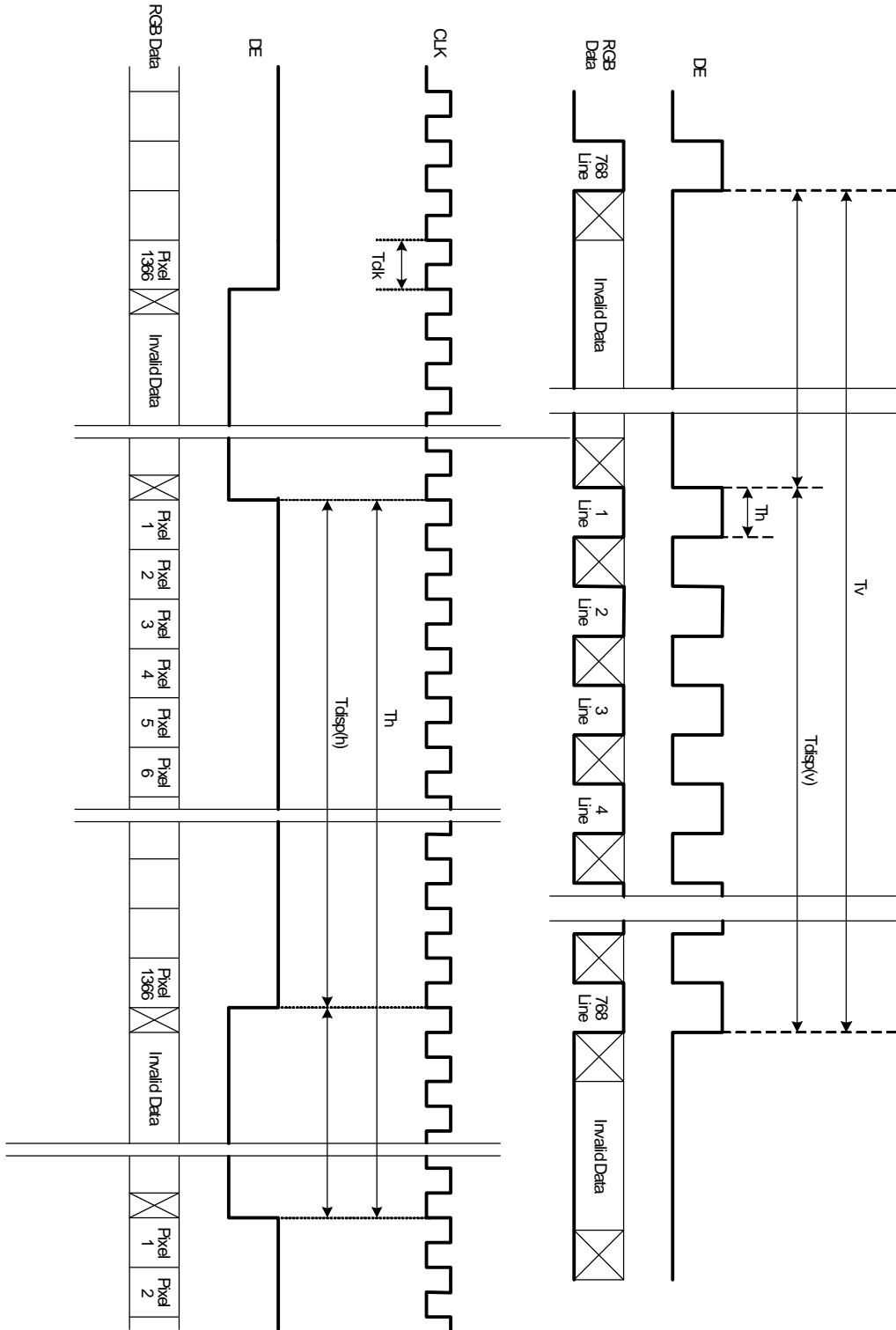
Vertical display position is specified by the rise of DE after a “Low” level period equivalent to eight times of horizontal period. The 1<sup>st</sup> data corresponding to one horizontal line after the rise of DE is displayed at the top line of screen.

\*3.) If a period of DE “High” is less than 1366 DCLK or less than 768 lines, the rest of the screen displays black.

\*4.) The display position does not fit to the screen if a period of DE “High” and the effective data period do not synchronize with each other.



### 3-4 Signal Timing Waveforms





### 3-5 Color Input Data Reference

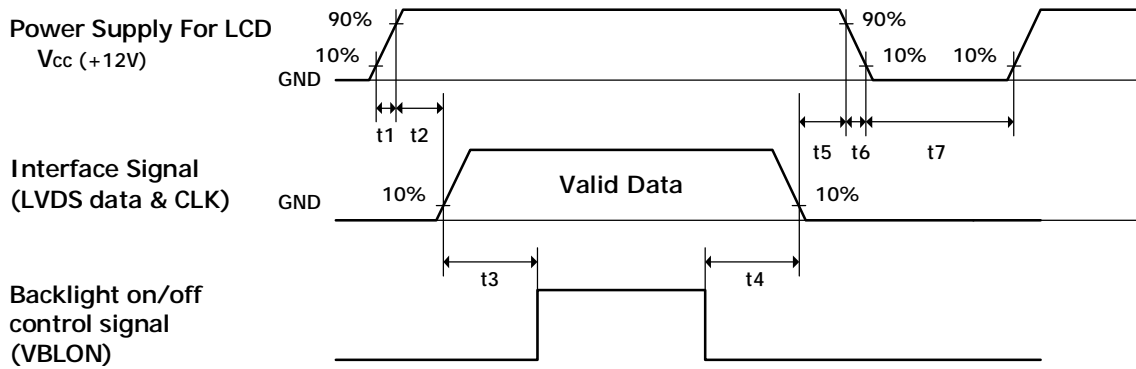
The brightness of each primary color (red, green and blue) is based on the 8 bit gray scale data input for the color; the higher the binary input, the brighter the color. The table below provides a reference for color versus data input.

#### COLOR DATA REFERENCE

Color		Input Color Data																							
		RED								GREEN								BLUE							
		MSB				LSB				MSB				LSB				MSB				LSB			
		R7	R6	R5	R4	R3	R2	R1	R0	G7	G6	G5	G4	G3	G2	G1	G0	B7	B6	B5	B4	B3	B2	B1	B0
Basic Color	Black	0	0	0	0	0	0	0	0	0	0	0	0	0	0	0	0	0	0	0	0	0	0	0	0
	Red(255)	1	1	1	1	1	1	1	1	0	0	0	0	0	0	0	0	0	0	0	0	0	0	0	0
	Green(255)	0	0	0	0	0	0	0	0	1	1	1	1	1	1	1	1	0	0	0	0	0	0	0	0
	Blue(255)	0	0	0	0	0	0	0	0	0	0	0	0	0	0	0	0	1	1	1	1	1	1	1	1
	Cyan	0	0	0	0	0	0	0	0	1	1	1	1	1	1	1	1	1	1	1	1	1	1	1	1
	Magenta	1	1	1	1	1	1	1	1	0	0	0	0	0	0	0	0	1	1	1	1	1	1	1	1
	Yellow	1	1	1	1	1	1	1	1	1	1	1	1	1	1	1	1	0	0	0	0	0	0	0	0
	White	1	1	1	1	1	1	1	1	1	1	1	1	1	1	1	1	1	1	1	1	1	1	1	1
RED	RED(000)	0	0	0	0	0	0	0	0	0	0	0	0	0	0	0	0	0	0	0	0	0	0	0	0
	RED(001)	0	0	0	0	0	0	0	1	0	0	0	0	0	0	0	0	0	0	0	0	0	0	0	0
	----																								
	RED(254)	1	1	1	1	1	1	1	0	0	0	0	0	0	0	0	0	0	0	0	0	0	0	0	0
	RED(255)	1	1	1	1	1	1	1	1	0	0	0	0	0	0	0	0	0	0	0	0	0	0	0	0
GREEN	GREEN(000)	0	0	0	0	0	0	0	0	0	0	0	0	0	0	0	0	0	0	0	0	0	0	0	0
	GREEN(001)	0	0	0	0	0	0	0	0	0	0	0	0	0	0	1	0	0	0	0	0	0	0	0	
	----																								
	GREEN(254)	0	0	0	0	0	0	0	0	1	1	1	1	1	1	0	0	0	0	0	0	0	0	0	
	GREEN(255)	0	0	0	0	0	0	0	0	1	1	1	1	1	1	1	0	0	0	0	0	0	0	0	
BLUE	BLUE(000)	0	0	0	0	0	0	0	0	0	0	0	0	0	0	0	0	0	0	0	0	0	0	0	0
	BLUE(001)	0	0	0	0	0	0	0	0	0	0	0	0	0	0	0	0	0	0	0	0	0	0	0	1
	-----																								
	BLUE(254)	0	0	0	0	0	0	0	0	0	0	0	0	0	0	0	0	1	1	1	1	1	1	1	0
	BLUE(255)	0	0	0	0	0	0	0	0	0	0	0	0	0	0	0	0	1	1	1	1	1	1	1	1



### 3-6 Power Sequence



Parameter	Values			Units
	Min.	Typ.	Max.	
t1	470	-	1000	us
t2	20	-	50	ms
t3	700 or (200)*1	-	-	ms
t4	200	-	-	ms
t5	50	-	-	ms
t6	0.47	-	30	ms
t7	1	-	-	s

\*1: If  $t_3=200\text{ms}$ , input black signal till 700ms from system is necessary.

In case of  $t_3 < 200\text{ms}$ , the abnormal display will be happened. But it will not damage timing controller.

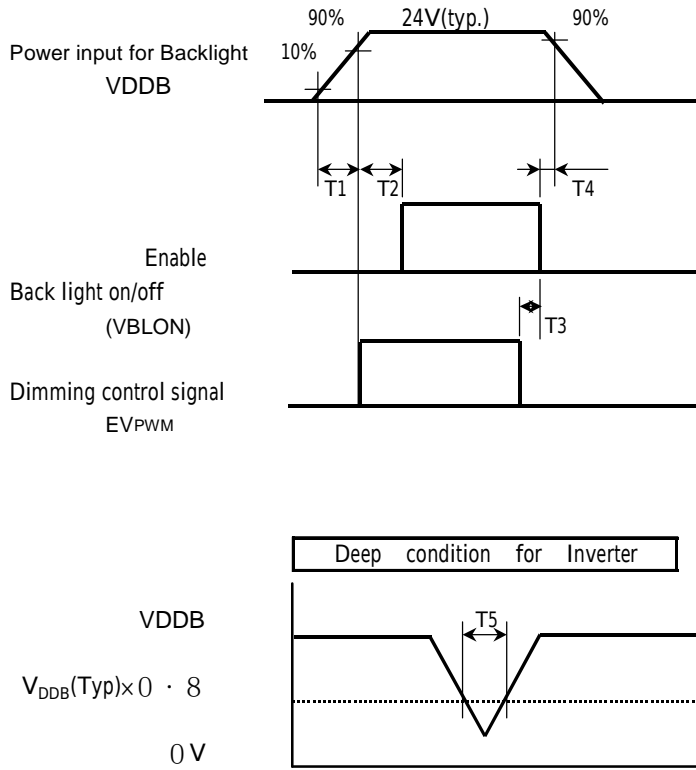
Note:

The timing controller will not be damaged in case of TV set AC input power suddenly shut down. Once power reset, it should follow power sequence as spec. definition.

- (1) Apply the lamp voltage within the LCD operation range. When the back-light turns on before the LCD operation or the LCD turns off before the back-light turns off, the display may momentarily become abnormal screen.



## Power Sequence for Inverter

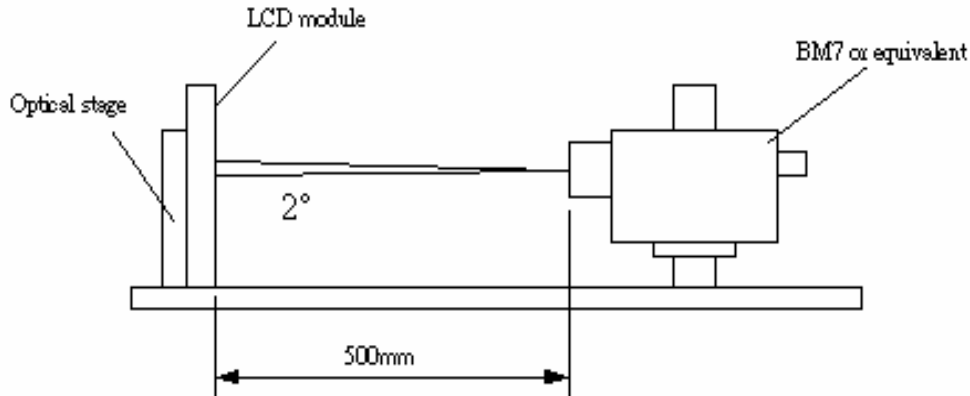


Parameter	Values			Units
	Min.	Typ.	Max.	
T1	20	-	-	ms
T2	500	-	-	ms
T3	0	-	-	ms
T4	1	-	-	ms
T5	-	-	10	ms

## 4. Optical Specification

Optical characteristics are determined after the unit has been 'ON' and stable for approximately 45 minutes in a dark environment at 25°C. The values specified are at an approximate distance 50cm from the LCD surface at a viewing angle of  $\Phi$  and  $\theta$  equal to 0°.

Fig.1 1 presents additional information concerning the measurement equipment and method.



Parameter	Symbol	Values			Units	Notes
		Min.	Typ.	Max.		
Contrast Ratio	CR	500	600			1
Dark Luminance	LBK			1.0	cd/m <sup>2</sup>	2
Surface Luminance, white	LWH	400	500		cd/m <sup>2</sup>	2
Luminance Variation	$\delta_{\text{WHITE}}$ 5 p			1.3		3
Response Time	Rise Time	$T_{\text{rR}}$	15		ms	4
	Decay Time	$T_{\text{rD}}$	5			
	Gray to Gray	$T_{\gamma}$	8			
Color Coordinates						
	RED	$R_{\text{x}}$	0.640	Typ.+0.03		
		$R_{\text{y}}$	0.330			
	GREEN	$G_{\text{x}}$	0.270			
		$G_{\text{y}}$	0.600			
	BLUE	$B_{\text{x}}$	0.150			
		$B_{\text{y}}$	0.060			
	WHITE	$W_{\text{x}}$	0.280			
		$W_{\text{y}}$	0.290			
Viewing Angle						
	x axis, right ( $\varphi = 0^\circ$ )	$\theta_{\text{r}}$	88		Degree	6
	x axis, left ( $\varphi = 180^\circ$ )	$\theta_{\text{l}}$	88		Degree	
	y axis, up ( $\varphi = 90^\circ$ )	$\theta_{\text{u}}$	88		Degree	
	y axis, down ( $\varphi = 0^\circ$ )	$\theta_{\text{d}}$	88		Degree	



Note:

1. Contrast Ratio (CR) is defined mathematically as:

$$\text{Contrast Ratio} = \frac{\text{Surface Luminance of } L_{on1}}{\text{Surface Luminance of } L_{off1}}$$

2. Surface luminance is luminance value at point 1 across the LCD surface 50cm from the surface with all pixels displaying white. From more information see FIG 2. When  $V_{DDB} = 24V$ ,  $I_{DDB} = 3.5A$ .  $L_{WH} = L_{on1}$

Where  $L_{on1}$  is the luminance with all pixels displaying white at center 1 location.

3. The variation in surface luminance,  $\delta_{WHITE}$  is defined (center of Screen) as:

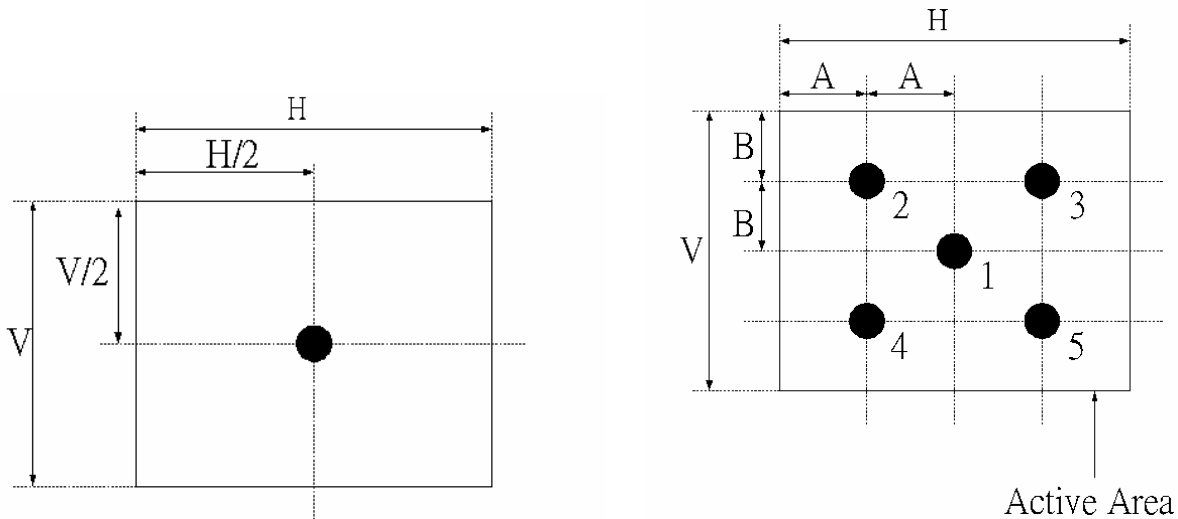
$$\delta_{WHITE(SP)} = \frac{\text{Maximum}(L_{on1}, L_{on2}, \dots, L_{on5})}{\text{Minimum}(L_{on1}, L_{on2}, \dots, L_{on5})}$$

4. Response time is the time required for the display to transition from black to white (Rise Time,  $Tr_R$ ) and from white to black (Decay Time,  $Tr_D$ ). For additional information see FIG3.

5.  $T_\gamma$  is the response time between any two gray scale and is based on  $f_v = 60Hz$  to optimize.

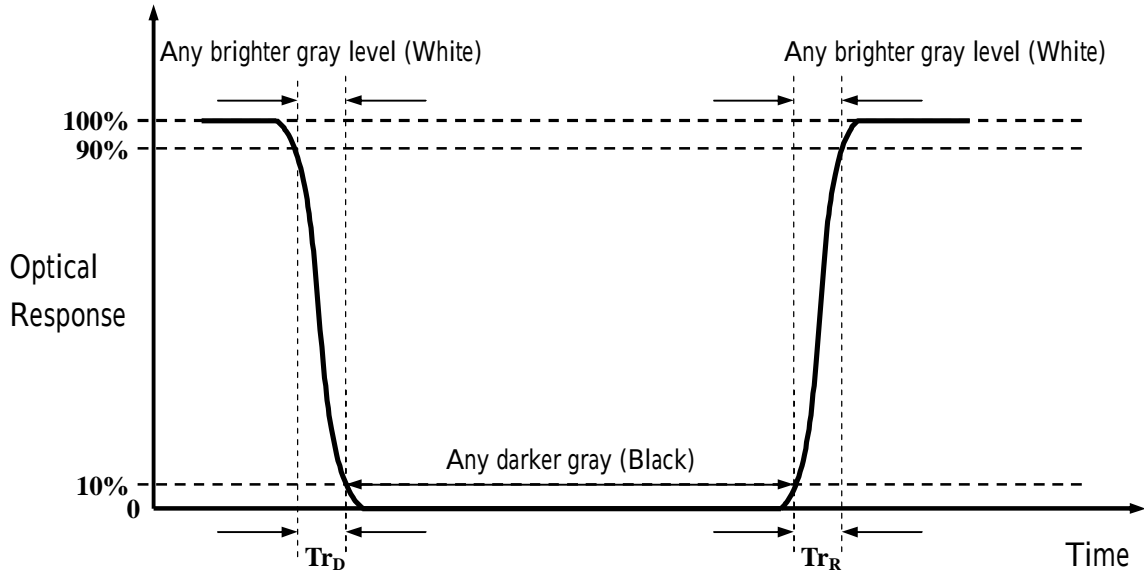
6. Viewing angle is the angle at which the contrast ratio is greater than 10. The angles are determined for the horizontal or x axis and the vertical or y axis with respect to the z axis which is normal to the LCD surface. For more information see FIG4.

**FIG. 2 Luminance**

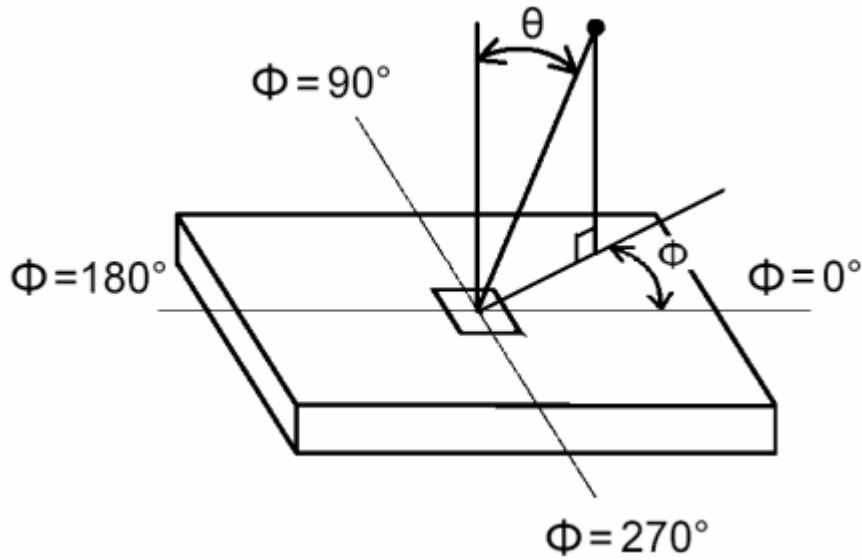


**FIG.3 Response Time**

The response time is defined as the following figure and shall be measured by switching the input signal for “black” and “white”.



**FIG.4 Viewing angle**





## 5. Mechanical Characteristics

The contents provide general mechanical characteristics for the model T260XW02. In addition the figures in the next page are detailed mechanical drawing of the LCD.

<b>Outline Dimension</b>	Horizontal	626.0mm
	Vertical	373.0mm
	Depth	43.3mm(w/i mylar inverter & Shielding)
<b>Bezel Area</b>	Horizontal	580.8mm
	Vertical	328.8mm
<b>Active Display Area</b>	Horizontal	575.769mm
	Vertical	323.712mm
<b>Weight</b>	4200g (Typ.)	
<b>Surface Treatment</b>	Anti-Glare (3H), Haze=40%	







## 6. Reliability

Environment test condition

No	Test Item	Condition
1	High temperature storage test	Ta=60°C 240h
2	Low temperature storage test	Ta=-20°C 240h
3	High temperature operation test	Ta=50°C 80%RH 240h
4	Low temperature operation test	Ta=0°C 240h
5	Vibration test (non-operating)	Wave form: random Vibration level : 1.0G RMS Bandwidth : 10-500Hz Duration: X, Y, Z 20min One time each direction
6	Shock test (non-operating)	Shock level: 100G Waveform: half sine wave, 2ms Direction: ±X, ±Y, ±Z One time each direction
7	Vibration test (with carton)	Random Vibration:10~200Hz,1.5G,30minutes in each X,Y,Z direction
8	Drop test (with carton)	Height: 53.3cm 1 corner, 3 edges, 6 surfaces (ASTMD4169-I)
9	Altitude Storage/shipment	50,000 feet (12Kpa)

{ Result Evaluation Criteria }

There should be no change which might affect the practical display function when the display quality test is conducted under normal operating condition.





## 7. International Standard

### 7-1. Safety

(1) UL1950 Third Edition, Underwriters Laboratories, Inc. Jan. 28, 1995

Standard for Safety of Information Technology Equipment Including electrical Business Equipment.

(2) CAN/CSA C22.2 No. 950-95 Third Edition, Canadian Standards Association, Jan. 28, 1995

Standard for Safety of Information Technology Equipment Including Electrical Business Equipment.

(3) EN60950 : 1992+A2: 1993+A2: 1993+C3: 1995+A4: 1997+A11: 1997

IEC 950: 1991+A1: 1992+A2: 1993+C3: 1995+A4:1996

European Committee for Electrotechnical Standardization (CENELEC)

EUROPEAN STANDARD for Safety of Information Technology Equipment Including Electrical Business Equipment.

### 7-2. EMC

a) ANSI C63.4 “Methods of Measurement of Radio-Noise Emissions from Low-Voltage Electrical and Electrical Equipment in the Range of 9kHz to 40GHz. “American National standards Institute(ANSI), 1992.

b) C.I.S.P.R “Limits and Methods of Measurement of Radio Interface Characteristics of Information Technology Equipment.” International Special committee on Radio Interference.

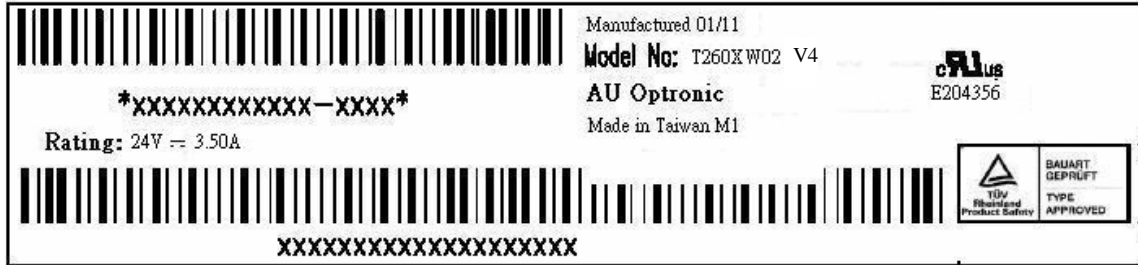
c) EN 55022 “Limits and Methods of Measurement of Radio Interface Characteristics of Information Technology Equipment.” European Committee for Electrotechnical Standardization. (CENELEC), 1998.



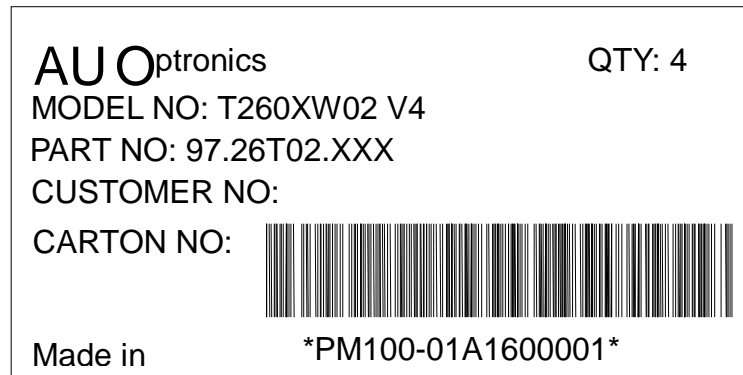


## 8. Packing

Label sample 83mm \* 23mm

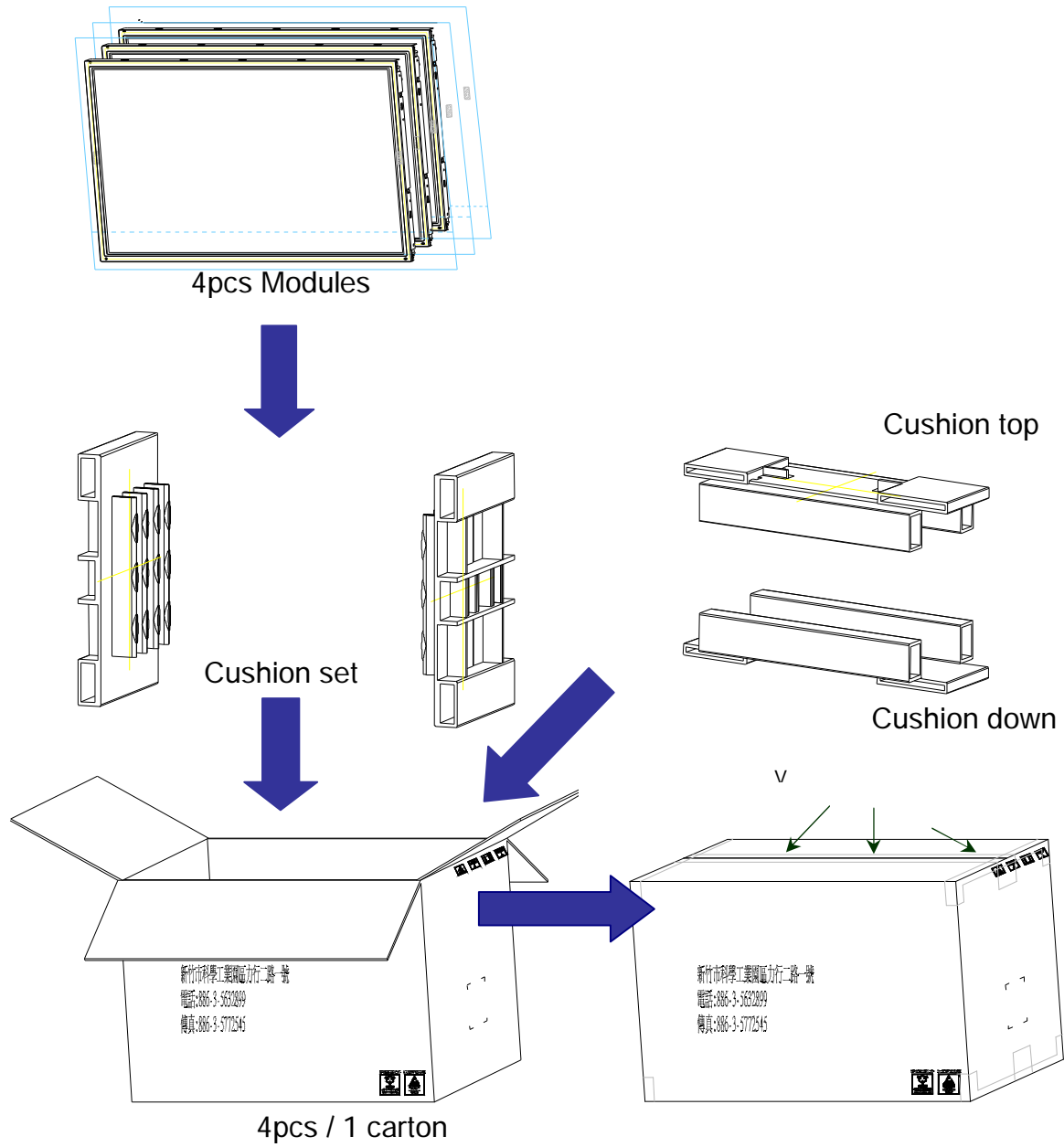


## Carton Label





Carton Size 767(L)mm\*330(W)mm\*480(H)mm





## 9. PRECAUTIONS

Please pay attention to the followings when you use this TFT LCD module.

### 9-1 MOUNTING PRECAUTIONS

- (1) You must mount a module using holes arranged in four corners or four sides.
- (2) You should consider the mounting structure so that uneven force (ex. Twisted stress) is not applied to module. And the case on which a module is mounted should have sufficient strength so that external force is not transmitted directly to the module.
- (3) Please attach the surface transparent protective plate to the surface in order to protect the polarizer. Transparent protective plate should have sufficient strength in order to resist external force.
- (4) You should adopt radiation structure to satisfy the temperature specification.
- (5) Acetic acid type and chlorine type materials for the cover case are not desirable because the former generates corrosive gas of attacking the polarizer at high temperature and the latter causes circuit break by electro-chemical reaction.
- (6) Do not touch, push or rub the exposed polarizers with glass, tweezers or anything harder than HB pencil lead. And please do not rub with dust clothes with chemical treatment. Do not touch the surface of polarizer for bare hand or greasy cloth. (Some cosmetics are detrimental to the polarizer.)
- (7) When the surface becomes dusty, please wipe gently with absorbent cotton or other soft materials like chamois soaks with petroleum benzene. Normal-hexane is recommended for cleaning the adhesives used to attach front/ rear polarizers. Do not use acetone, toluene and alcohol because they cause chemical damage to the polarizer.
- (8) Wipe off saliva or water drops as soon as possible. Their long time contact with polarizer causes deformations and color fading.
- (9) Do not open the case because inside circuits do not have sufficient strength.

### 9-2 OPERATING PRECAUTIONS

- (1) The spike noise causes the mis-operation of circuits. It should be lower than following voltage:  $V = \pm 200\text{mV}$  (Over and under shoot voltage)
- (2) Response time depends on the temperature. (In lower temperature, it becomes longer..)
- (3) Brightness depends on the temperature. (In lower temperature, it becomes lower.) And in lower temperature, response time (required time that brightness is stable after turned on) becomes longer.
- (4) Be careful for condensation at sudden temperature change. Condensation makes damage to polarizer or electrical contacted parts. And after fading condensation, smear or spot will occur.
- (5) When fixed patterns are displayed for a long time, remnant image is likely to occur.
- (6) Module has high frequency circuits. Sufficient suppression to the electromagnetic interference shall be done by system manufacturers. Grounding and shielding methods may be important to minimize the interface.



### **9-3 ELECTROSTATIC DISCHARGE CONTROL**

Since a module is composed of electronic circuits, it is not strong to electrostatic discharge. Make certain that treatment persons are connected to ground through wrist band etc. And don't touch interface pin directly.

### **9-4 PRECAUTIONS FOR STRONG LIGHT EXPOSURE**

Strong light exposure causes degradation of polarizer and color filter.

### **9-5 STORAGE**

When storing modules as spares for a long time, the following precautions are necessary.

- (1) Store them in a dark place. Do not expose the module to sunlight or fluorescent light. Keep the temperature between 5°C and 35°C at normal humidity.
- (2) The polarizer surface should not come in contact with any other object. It is recommended that they be stored in the container in which they were shipped.

### **9-6 HANDLING PRECAUTIONS FOR PROTECTION FILM**

- (1) The protection film is attached to the bezel with a small masking tape. When the protection film is peeled off, static electricity is generated between the film and polarizer. This should be peeled off slowly and carefully by people who are electrically grounded and with well ion-blown equipment or in such a condition, etc.
- (2) When the module with protection film attached is stored for a long time, sometimes there remains a very small amount of glue still on the Bezel after the protection film is peeled off.
- (3) You can remove the glue easily. When the glue remains on the Bezel or its vestige is recognized, please wipe them off with absorbent cotton waste or other soft material like chamois soaked with normal-hexane.