

ESDA6V8BLF

2-Line, Uni-directional, Low-Capacitance, Transient Voltage Suppressors

Descriptions

The ESDA6V8BLF is a bi-directional transient voltage suppressors (TVS) which provide a very high level protection for sensitive electronic components that may be subjected to electrostatic discharge (ESD). It is designed to replace multilayer varistors (MLV) in consumer equipments applications such as mobile phone, notebook, PAD, STB, LCD TV etc.

The ESDA6V8BLF is based on solid-state silicon technology and offer unique electrical characteristics like lower clamping voltage and no device degrading compared to MLV.

The ESDA6V8BLF is past ESD transient voltage up to $\pm 8\text{KV}$ (contact) according to IEC61000-4-2 and will withstand peak current up to 3.5A for 8/20us pulse to meet the IEC61000-4-5.

The ESDA6V8BLF is available in SOT-23-3L package. Standard products are Pb-free and Halogen-free.

Features

- Working voltage: $\pm 5.0\text{V}$ Max
- Transient protection for each line according to IEC61000-4-2 (ESD): $\pm 8\text{kV}$ (contact discharge)
 $\pm 15\text{kV}$ (air discharge)
- IEC61000-4-4 (EFT): 40A (5/50ns)
- IEC61000-4-5 (surge): 3.5A (8/20 μs)
- Low leakage current
- Small package

Applications

- Cell phone
- Notebook
- STB
- Digital camera
- Other electronics equipments

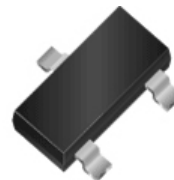

SOT-23

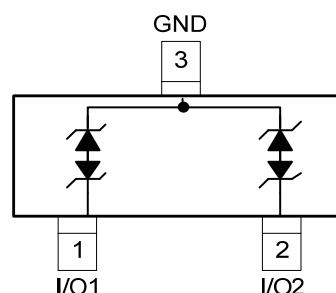

Circuit Diagram

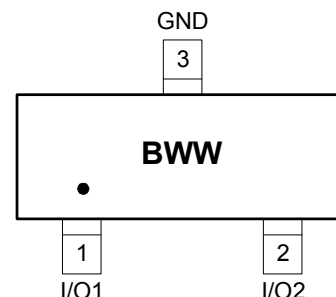

SOT-23

B = Device code

WW = Date code

Marking & Pin configuration

Order information

Device	Package	Shipping
ESDA6V8BLF-3/TR	SOT-23	3000/Tape&Reel

Absolute maximum ratings

ESDA6V8BLF

Parameter	Symbol	Rating	Unit
Peak pulse power (tp=8/20us)	Ppk	38	W
Peak pulse current (tp=8/20us)	Ipp	3.5	A
ESD voltage IEC61000-4-2 air	V _{ESD}	±15	kV
ESD voltage IEC61000-4-2 contact		±8	
Junction temperature	T _J	125	°C
Operating temperature	T _{OP}	-40~85	°C
Lead temperature	T _L	260	°C
Storage temperature	T _{STG}	-55~150	°C

Electronics characteristics (Ta=25°C, unless otherwise noted)

Parameter	Symbol	Condition	Min.	Typ.	Max.	Unit
Reveres maximum working voltage	V _{RWM}				±5.0	V
Reveres leakage current	I _R	V _{RWM} =5V			1.0	uA
Reveres breakdown voltage	V _{BR12}	I _T =1mA	6.5	7.7	8.1	V
Forward voltage	V _{BR21}	I _F =1mA	6.5	7.8	8.1	V
Clamping voltage	V _C	Ipp=1A tp=8/20us			8	V
		Ipp=3.5A tp=8/20us			11	V
Junction capacitance	C _J	F=1MHz, V _R =0V Any I/O pin to Gnd		5.0	10	pF
		F=1MHz, V _R =0V Between I/O pins		2.5	5	pF

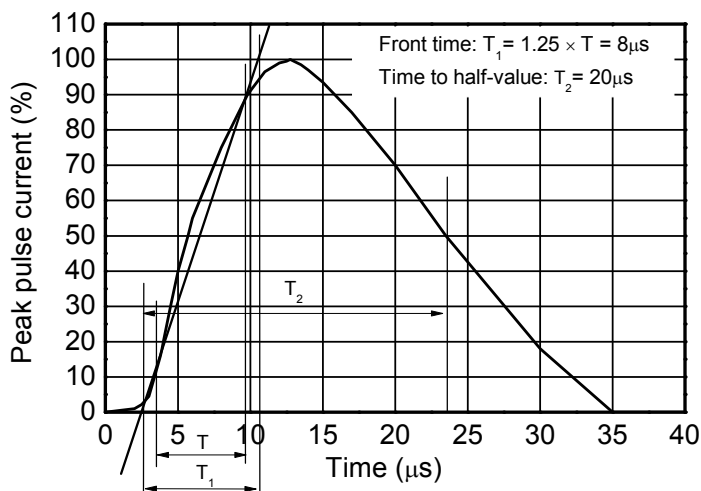

8/20us waveform

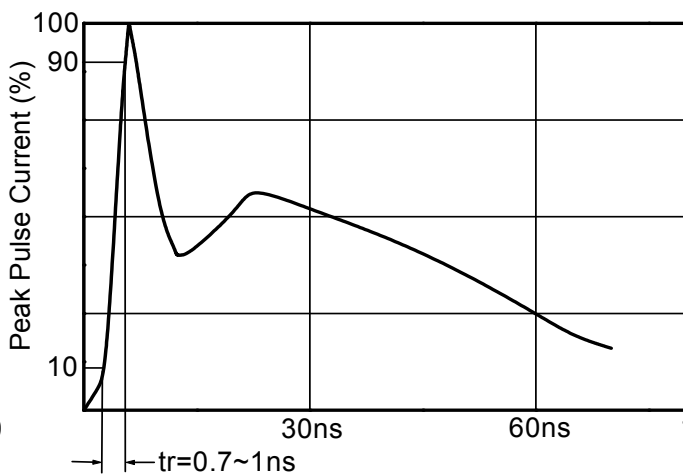

IEC61000-4-2 waveform

Typical characteristics (Ta=25°C, unless otherwise noted)

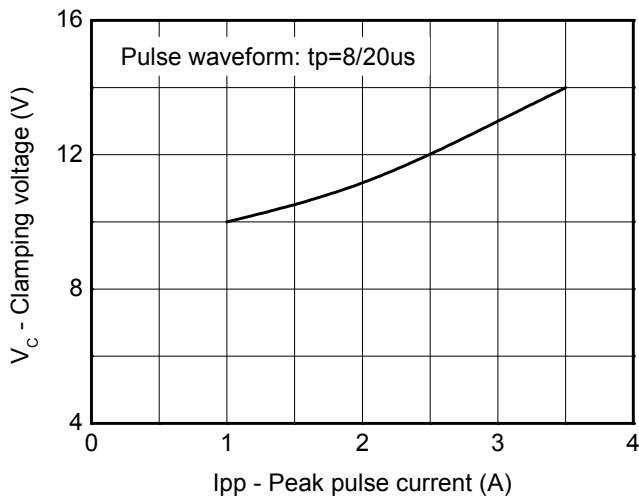

Clamping voltage vs. Peak pulse current

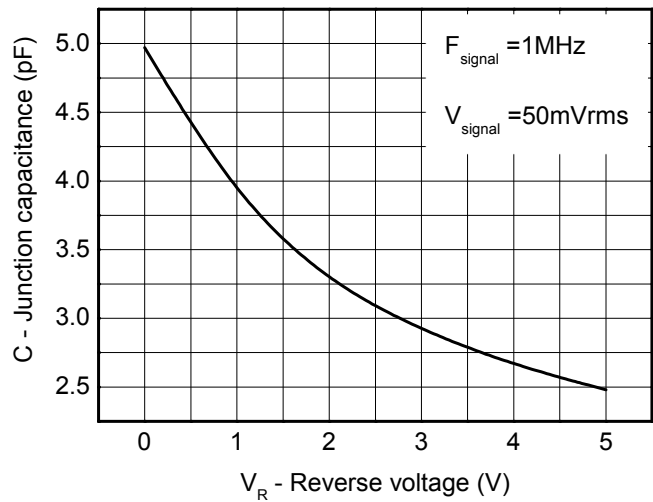

Capacitance vs. Reverse voltage

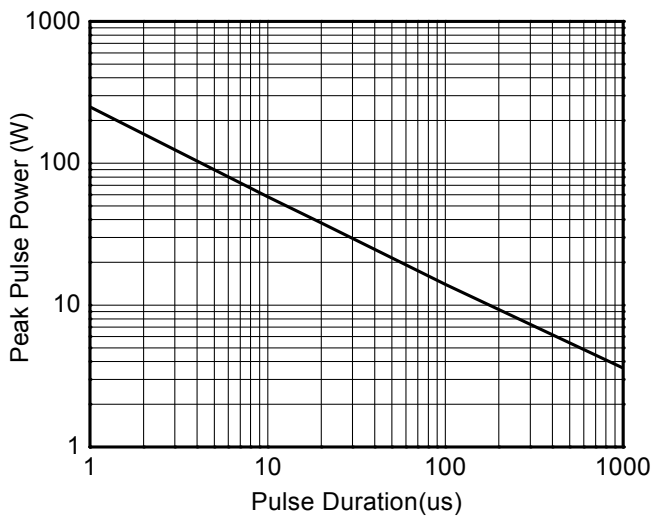

Non-Repetitive Peak Pulse Power vs. Pulse time

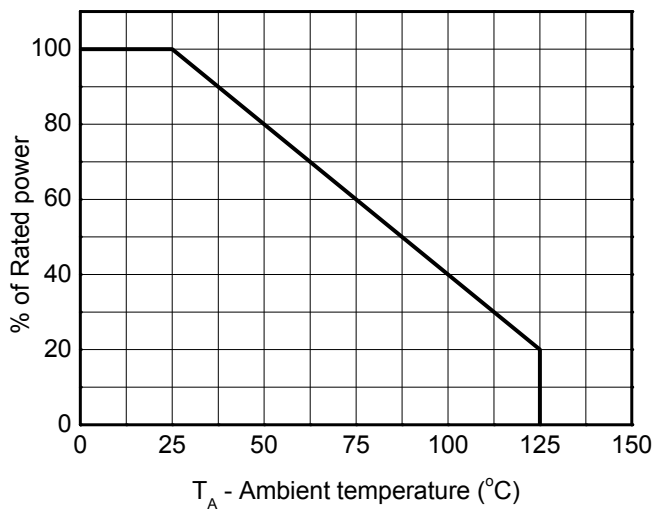

Power derating vs. Temperature

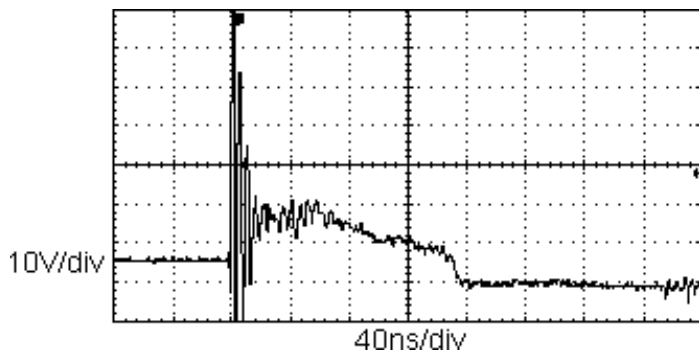

**ESD clamping voltage
(IEC61000-4-2 +8kV contact)**

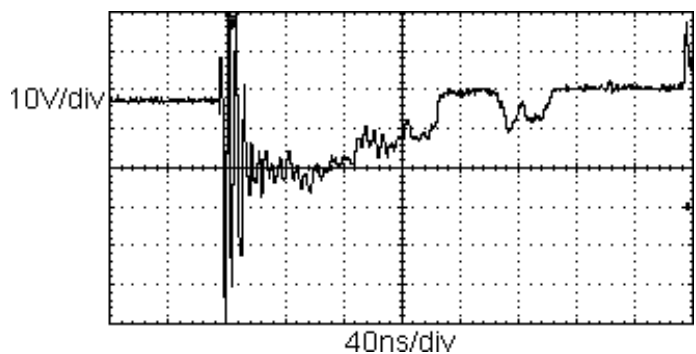

**ESD clamping voltage
(IEC61000-4-2 -8kV contact)**

Package outline dimensions

SOT-23

ESDA6V8BLF

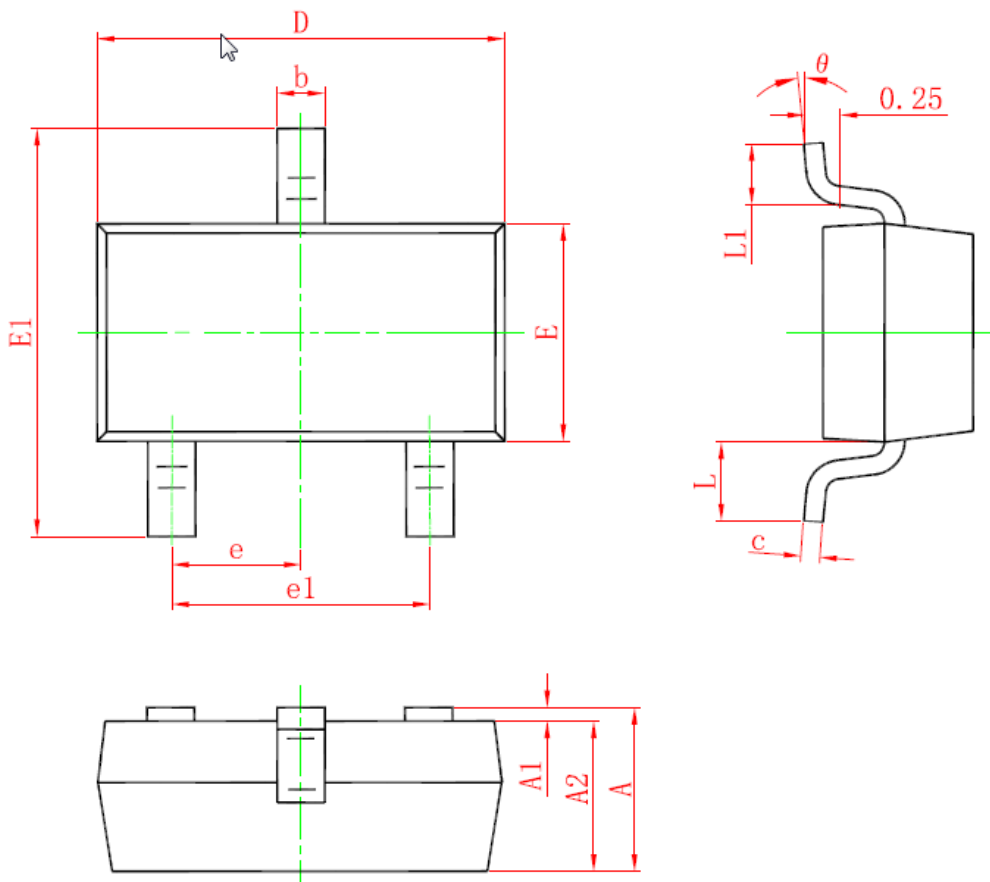

Symbol	Dimensions in millimeter		Dimensions in inches	
	Min.	Max.	Min.	Max.
A	0.900	1.150	0.035	0.045
A1	0.000	0.100	0.000	0.004
A2	0.900	1.050	0.035	0.041
b	0.300	0.500	0.012	0.020
c	0.080	0.150	0.003	0.006
D	2.800	3.000	0.110	0.118
E	1.200	1.400	0.047	0.055
E1	2.250	2.550	0.089	0.100
e	0.950TYP		0.037TYP	
e1	1.800	2.000	0.071	0.079
L	0.500REF		0.022REF	
L1	0.300	0.500	0.012	0.020
θ	0°	8°	0°	8°