

LM193/A/293/A/393/A/ 2903

Low Power Dual Voltage Comparator

Linear Products

Product Specification

DESCRIPTION

The LM193 series consists of two independent precision voltage comparators with an offset voltage specification as low as 2.0mV max. for two comparators which were designed specifically to operate from a single power supply over a wide range of voltages. Operation from split power supplies is also possible and the low power supply current drain is independent of the magnitude of the power supply voltage. These comparators also have a unique characteristic in that the input common-mode voltage range includes ground, even though operated from a single power supply voltage.

The LM193 series was designed to directly interface with TTL and CMOS. When operated from both plus and minus power supplies, the LM193 series will directly interface with MOS logic where their low power drain is a distinct advantage over standard comparators.

FEATURES

- Wide single supply voltage range $2.0V_{DC}$ to $36V_{DC}$ or dual supplies $\pm 1.0V_{DC}$ to $\pm 18V_{DC}$
- Very low supply current drain (0.8mA) independent of supply voltage (2.0mW/comparator at $5.0V_{DC}$)
- Low input biasing current 25nA
- Low input offset current $\pm 5nA$ and offset voltage $\pm 2mV$
- Input common-mode voltage range includes ground
- Differential input voltage range equal to the power supply voltage
- Low output 250mV at 4mA saturation voltage
- Output voltage compatible with TTL, DTL, ECL, MOS and CMOS logic systems

APPLICATIONS

- A/D converters
- Wide range VCO
- MOS clock generator
- High voltage logic gate
- Multivibrators

PIN CONFIGURATION

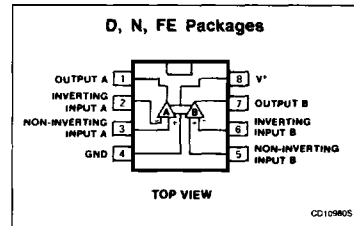

EQUIVALENT CIRCUIT

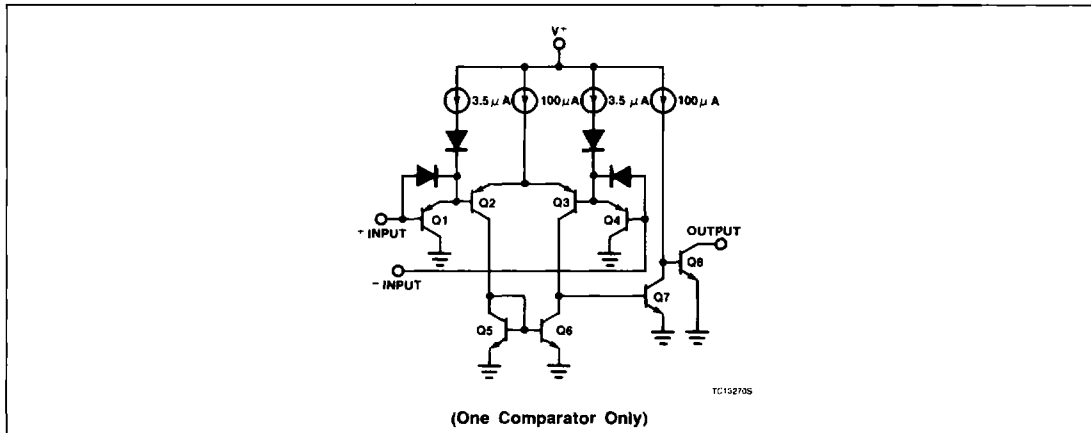

Low Power Dual Voltage Comparator

LM193/A/293/A/393/A/2903

ORDERING INFORMATION

DESCRIPTION	TEMPERATURE RANGE	ORDER CODE
8-Pin Cerdip	-55°C to +125°C	LM193AF
8-Pin Cerdip	-55°C to +125°C	LM193FE
8-Pin Cerdip	-25°C to +85°C	LM293AFE
8-Pin Cerdip	-25°C to +85°C	LM293FE
8-Pin Plastic DIP	-25°C to +85°C	LM293N
8-Pin Plastic SO	-25°C to +85°C	LM293D
8-Pin Plastic DIP	-25°C to +85°C	LM293AN
8-Pin Cerdip	0 to +70°C	LM393AFE
8-Pin Cerdip	0 to +70°C	LM393FE
8-Pin Plastic SO	0 to +70°C	LM393D
8-Pin Plastic DIP	0 to +70°C	LM393N
8-Pin Plastic DIP	0 to +70°C	LM393AN
8-Pin Plastic DIP	-40°C to +85°C	LM2903N
8-Pin Plastic DIP	-40°C to +85°C	LM2903D

ABSOLUTE MAXIMUM RATINGS

SYMBOL	PARAMETER	RATING	UNIT
V_{CC}	Supply voltage	36 or ± 18	V_{DC}
	Differential input voltage	36	V_{DC}
V_{IN}	Input voltage	-0.3 to +36	V_{DC}
P_D	Maximum power dissipation, $T_A = 25^\circ\text{C}$ (still-air) ¹		
	F package	780	mW
	N package	1160	mW
	D package	780	mW
	Output short-circuit to ground ²	Continuous	
I_{IN}	Input current ($V_{IN} < -0.3V_{DC}$) ³	50	mA
T_A	Operating temperature range		
	LM193/193A	-55 to +125	°C
	LM293/293A	-25 to +85	°C
	LM393/393A	0 to +70	°C
	LM2903	-40 to +85	°C
T_{STG}	Storage temperature range	-65 to +150	°C
T_{SOLD}	Lead soldering temperature (10sec max)	300	°C

NOTES:

- Derate above 25°C, at the following rates:
F package at 6.2mW/°C
N package at 9.3mW/°C
D package at 6.2mW/°C
- Short circuits from the output to V_+ can cause excessive heating and eventual destruction. The maximum output current is approximately 20mA independent of the magnitude of V_+ .
- This input current will only exist when the voltage at any of the input leads is driven negative. It is due to the collector-base junction of the input PNP transistors becoming forward biased and thereby acting as input diode clamps. In addition to this diode action, there is also lateral NPN parasitic transistor action on the IC chip. This transistor action can cause the output voltages of the comparators to go to the V_+ voltage level (or to ground for a large overdrive) for the time duration that an input is driven negative. This is not destructive and normal output states will re-establish when the input voltage, which was negative, again returns to a value greater than $-0.3V_{DC}$.

Low Power Dual Voltage Comparator

LM193/A/293/A/393/A/2903

DC AND AC ELECTRICAL CHARACTERISTICS $V_+ = 5V_{DC}$, LM193/193A: $-55^\circ\text{C} \leq T_A \leq +125^\circ\text{C}$, unless otherwise specified.
 LM293/293A: $-25^\circ\text{C} \leq T_A \leq +85^\circ\text{C}$, unless otherwise specified.
 LM393/393A: $0^\circ\text{C} \leq T_A \leq +70^\circ\text{C}$, unless otherwise specified.
 LM2903: $-40^\circ\text{C} \leq T_A \leq +85^\circ\text{C}$, unless otherwise specified.

SYMBOL	PARAMETER	TEST CONDITIONS	LM193A			LM293A/393A			LM2903			UNIT
			Min	Typ	Max	Min	Typ	Max	Min	Typ	Max	
V_{OS}	Input offset voltage ²	$T_A = 25^\circ\text{C}$ Over temp.		± 1.0	± 2.0 ± 4.0		± 1.0	± 2.0 ± 4.0		± 2.0 ± 9	± 7.0 ± 15	mV mV
V_{CM}	Input common-mode voltage range ^{3, 6}	$T_A = 25^\circ\text{C}$ Over temp.	0 0		$V_+ - 1.5$ $V_+ - 2.0$	0 0		$V_+ - 1.5$ $V_+ - 2.0$	0 0		$V_+ - 1.5$ $V_+ - 2.0$	V V
V_{IDR}	Differential input voltage ¹	Keep all $V_{INs} \geq 0V_{DC}$ (or V_- if need)			V_+			V_+			V_+	V
i_{BIAS}	Input bias current ⁴	$I_{IN(+)}$ or $I_{IN(-)}$ with output in linear range $T_A = 25^\circ\text{C}$ Over temp.		25	100 300		25	250 400		25 200	250 500	nA nA
I_{OS}	Input offset current	$I_{IN(+)} - I_{IN(-)}$ $T_A = 25^\circ\text{C}$ Over temp.		± 3.0	± 25 ± 100		± 5.0	± 50 ± 150		± 5 ± 50	± 50 ± 200	nA nA
I_{OL}	Output sink current	$V_{IN(-)} \geq 1V_{DC}$, $V_{IN(+)} = 0$, $V_0 \leq 1.5V_{DC}$ $T_A = 25^\circ\text{C}$	6.0	16		6.0	16		6.0	16		mA
I_{OH}	Output leakage current	$V_{IN(+)} \geq 1V_{DC}$, $V_{IN(-)} = 0$ $V_0 = 30V_{DC}$ Over temp. $V_0 = 5V_{DC}$, $T_A = 25^\circ\text{C}$		0.1	1.0		0.1	1.0		0.1	1.0	nA μA
I_{CC}	Supply current	$R_L = \infty$ on both comparators. $T_A = 25^\circ\text{C}$ $V_+ = 30V$, over temp.		0.8 1	1 2.5		0.8 1	1 2.5		0.8 1	1 2.5	mA mA
A_V	Voltage gain	$R_L \geq 15k\Omega$, $V_+ = 15V_{DC}$, $T_A = 25^\circ\text{C}$	50	200		50	200		25	100		V/ mV
V_{OL}	Saturation voltage	$V_{IN(-)} \geq 1V_{DC}$, $V_{IN(+)} = 0$, $I_{SINK} \leq 4\text{mA}$ $T_A = 25^\circ\text{C}$ Over temp.		250	400 700		250	400 700		400	400 700	mV mV
t_{LSR}	Large-signal response time	$V_{IN} = \text{TTL logic swing}$, $V_{REF} = 1.4V_{DC}$ $V_{RL} = 5V_{DC}$, $R_L = 5.1k\Omega$, $T_A = 25^\circ\text{C}$		300			300			300		ns
t_R	Response time ⁵	$V_{RL} = 5V_{DC}$, $R_L = 5.1k\Omega$ $T_A = 25^\circ\text{C}$		1.3			1.3			1.3		μs

Low Power Dual Voltage Comparator

LM193/A/293/A/393/A/2903

DC ELECTRICAL CHARACTERISTICS (Continued)

$V_+ = 5V_{DC}$, LM193/193A: $-55^{\circ}\text{C} \leq T_A \leq +125^{\circ}\text{C}$, unless otherwise specified.
 LM293/293A: $-25^{\circ}\text{C} \leq T_A \leq +85^{\circ}\text{C}$, unless otherwise specified.
 LM393/393A: $0^{\circ}\text{C} \leq T_A \leq +70^{\circ}\text{C}$, unless otherwise specified.
 LM2903: $-40^{\circ}\text{C} \leq T_A \leq +85^{\circ}\text{C}$, unless otherwise specified.

SYMBOL	PARAMETER	TEST CONDITIONS	LM193			LM293/393			UNIT
			Min	Typ	Max	Min	Typ	Max	
V_{OS}	Input offset voltage ²	$T_A = 25^{\circ}\text{C}$ Over temp.		± 2.0	± 5.0 ± 9.0		± 2.0	± 5.0 ± 9.0	mV mV
V_{CM}	Input common-mode voltage range ^{3, 6}	$T_A = 25^{\circ}\text{C}$ Over temp.	0 0		$V_{\pm} - 1.5$ $V_{\pm} - 2.0$	0 0		$V_+ - 1.5$ $V_+ - 2.0$	V V
V_{IDR}	Differential input voltage ¹	Keep all $V_{INs} \geq 0V_{DC}$ (or V_- if need)			V_+			V_+	V
I_{BIAS}	Input bias current ⁴	$I_{IN(+)}$ or $I_{IN(-)}$ with output in linear range $T_A = 25^{\circ}\text{C}$ Over temp.		25	100 300		25	250 400	nA nA
I_{OS}	Input offset current	$I_{IN(+)} - I_{IN(-)}$ $T_A = 25^{\circ}\text{C}$ Over temp.		± 3.0	± 25 ± 100		± 5.0	± 50 ± 150	nA nA
I_{OL}	Output sink current	$V_{IN(-)} \geq 1V_{DC}$, $V_{IN(+)} = 0$, $V_O \leq 1.5V_{DC}$ $T_A = 25^{\circ}\text{C}$	6.0	16		6.0	16		mA
I_{OH}	Output leakage current	$V_{IN(+)} \geq 1V_{DC}$, $V_{IN(-)} = 0$, $V_O = 5V_{DC}$ $T_A = 25^{\circ}\text{C}$ $V_O = 30V_{DC}$ over temp.		0.1	1.0		0.1	1.0	nA μA
I_{CC}	Supply current	$R_L = \infty$ on both comparators $T_A = 25^{\circ}\text{C}$ $V_+ = 30V$, over temp.		0.8	1 2.5		0.8	1 2.5	mA mA
A_V	Voltage gain	$R_L \geq 15k\Omega$, $V_+ = 15V_{DC}$	50	200		50	200		V/mV
V_{OL}	Saturation voltage	$V_{IN(-)} \geq 1V_{DC}$, $V_{IN(+)} = 0$, $I_{SINK} \leq 4\text{mA}$ $T_A = 25^{\circ}\text{C}$ Over temp.		250	400 700		250	400 700	mV mV
t_{LSR}	Large signal response time	$V_{IN} = \text{TTL logic swing}$, $V_{REF} = 1.4V_{DC}$, $V_{RL} = 5V_{DC}$ $R_L = 5.1k\Omega$, $T_A = 25^{\circ}\text{C}$		300			300		ns
t_R	Response time ⁵	$V_{RL} = 5V_{DC}$, $R_L = 5.1k\Omega$ $T_A = 25^{\circ}\text{C}$		1.3			1.3		μs

NOTES:

- Positive excursions of input voltage may exceed the power supply level by 17V. As long as the other voltage remains within the common-mode range, the comparator will provide a proper output state. The low input voltage state must not be less than $-0.3V_{DC}$ (V_{DC} below the magnitude of the negative power supply, if used).
- At output switch point, $V_O \cong 1.4V_{DC}$, $R_S = 0\Omega$ with V_+ from $5V_{DC}$ to $30V_{DC}$ and over the full input common-mode range ($0V_{DC}$ to $V_+ - 1.5V_{DC}$).
- The input common-mode voltage or either input signal voltage should not be allowed to go negative by more than 0.3V. The upper end of the common-mode voltage range is $V_+ - 1.5V$, but either or both inputs can go to $30V_{DC}$ without damage.
- The direction of the input current is out of the IC due to the PNP input stage. This current is essentially constant, independent of the state of the output so no loading change exists on the reference or input lines.
- The response time specified is for a 100mV input step with a 5mV overdrive.
- For input signals that exceed V_{CC} , only the overdriven comparator is affected. With a 5V supply, V_{IN} should be limited to 25V maximum, and a limiting resistor should be used on all inputs that might exceed the positive supply.

Low Power Dual Voltage Comparator

LM193/A/293/A/393/A/2903

TYPICAL APPLICATIONS

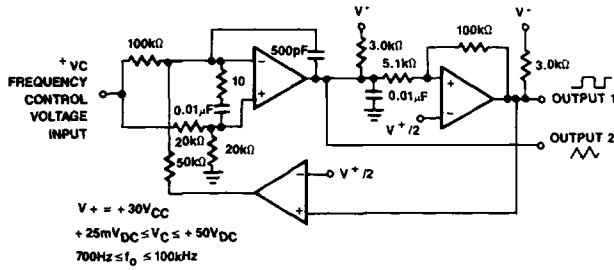

Two-Decade High-Frequency VCO

TC122905

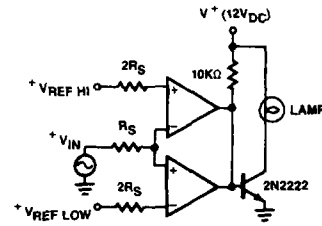

Limit Comparator

TC122906

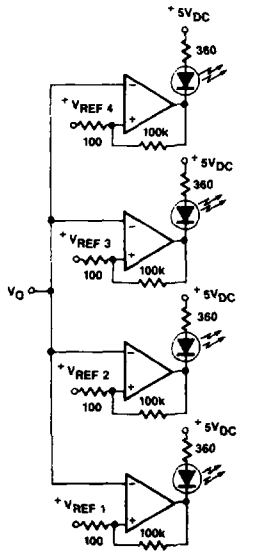

Visible Voltage Indicator

LD064005

NOTE:
All pins of any unused comparators should be grounded.

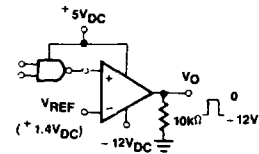

TTL-to-MOS Logic Converter

TC133805

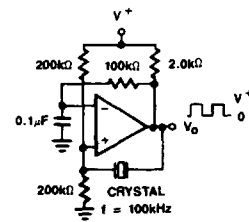

Crystal-Controlled Oscillator

TC133105

Low Power Dual Voltage Comparator

LM193/A/293/A/393/A/2903

TYPICAL PERFORMANCE CHARACTERISTICS

Input Current

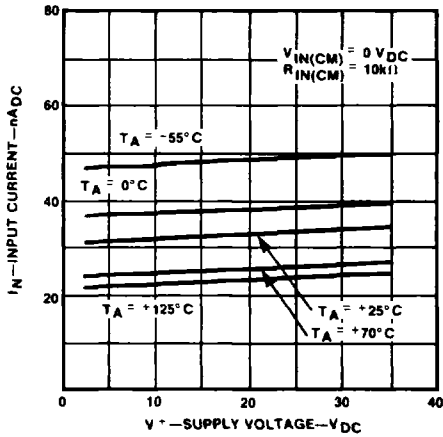

OP055805

Output Saturation Voltage

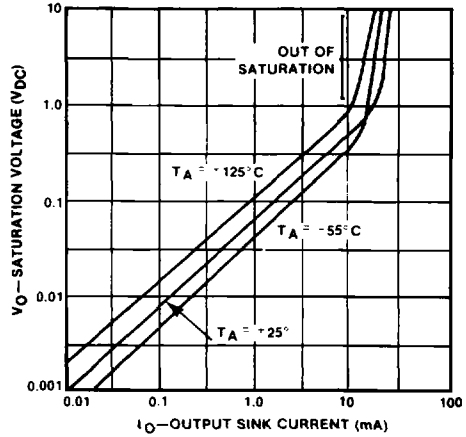

OP055805

Response Time for Various Input Overdrives — Negative Transition

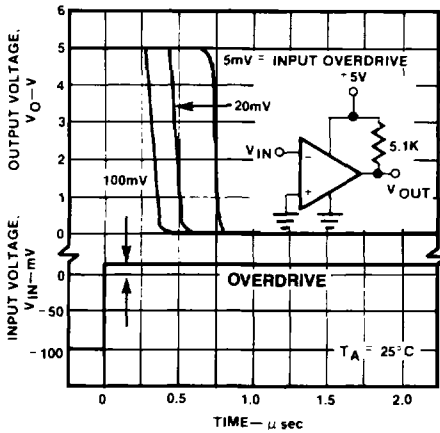

OP056005

Response Time for Various Input Overdrives — Positive Transition

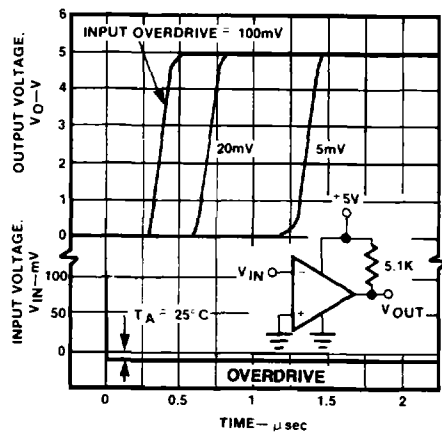

OP056105