

DATE	REV	ECN	APP'D. BY
2/3/06	A2	7459	JM
4-2-07	A3	7987	TRM
12-29-08	A4	8628	TJA

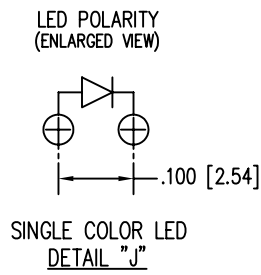

LED SPECIFICATIONS			
STANDARD LED	FORWARD VOLTAGE (MAX)	* FORWARD VOLTAGE (TYP)	WAVELENGTH
YELLOW	2.5 V	2.1 V	590 nm
GREEN	2.5 V	2.2 V	565 nm

\* WITH A FORWARD CURRENT OF 20 mA (TYP)

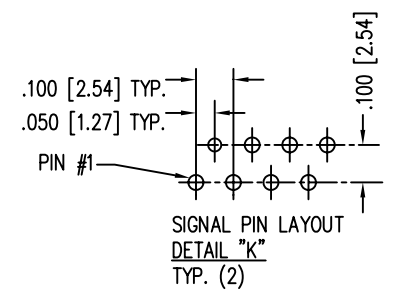
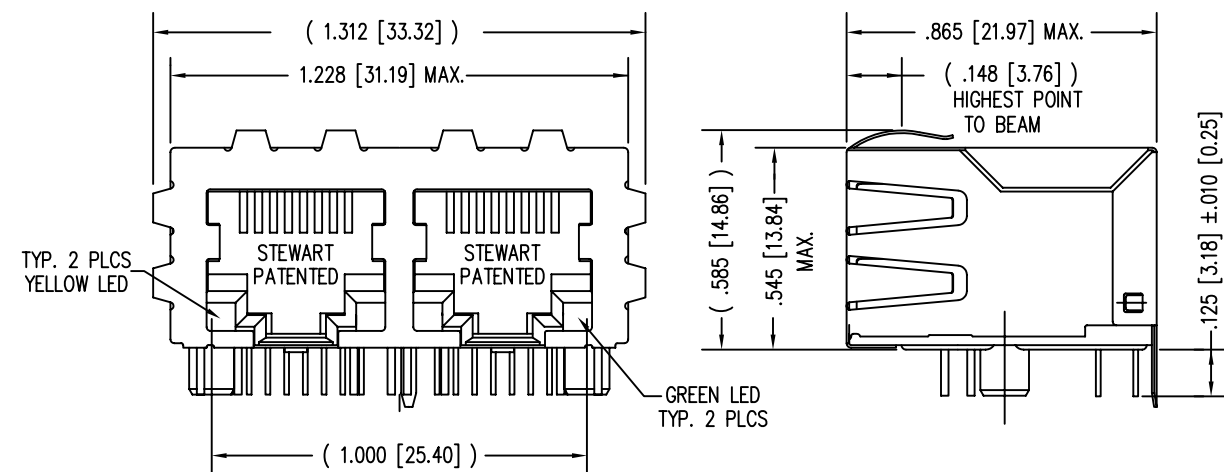
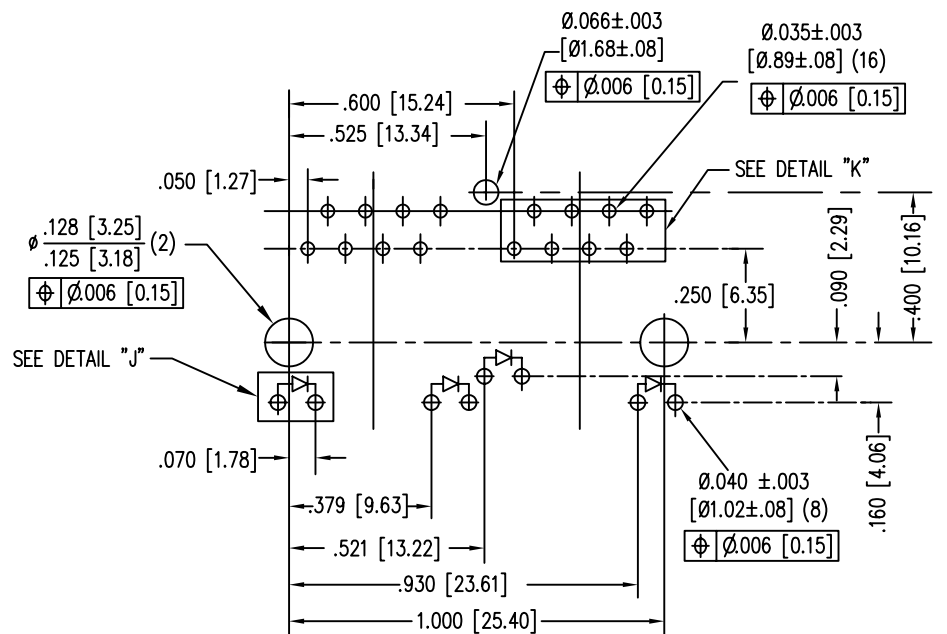
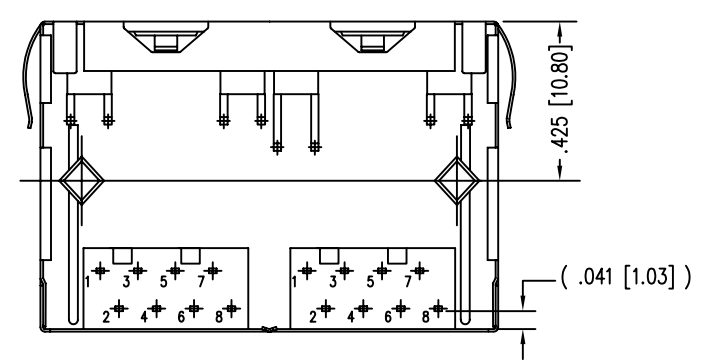

P.C.B. RECOMMENDED HOLE LAYOUT  
SEEN FROM COMPONENT SIDE  
ALL CENTERLINE DIMENSIONS ARE BASIC.

- NOTES:
- CONNECTOR MATERIALS:  
HOUSING: THERMOPLASTIC UL94 V-0  
CONTACTS/SHIELD: COPPER ALLOY  
SHIELD PLATING: NICKEL OR "REFLOW" TIN  
CONTACT PLATING: SELECTIVE GOLD IN CONTACT AREA  
SEE CHART FOR PART NUMBER
  - PRODUCT DESIGNED FOR CATEGORY 5 APPLICATIONS.
  - DIMENSIONS AND TOLERANCES COMPLY WITH FCC/CFR 47, PART 68.
  - FOR PRODUCT SPECIFICATIONS SEE PRO22-01.
  - THE SUGGESTED PANEL OPENING IS INTENDED TO GIVE USER THE ABILITY TO HAVE REASONABLE JACK/PANEL CLEARANCES, YET MAINTAIN GROUNDING CAPABILITY. THESE VARIABLES CAN BE ADJUSTED IN EITHER DIRECTION BUT MAY CARRY SOME CONSEQUENCES IN THE FORM OF LOWER MATING FORCES OR TIGHTER ASSEMBLY TOLERANCES.

30 MICRO-INCHES [0.76um]	SS-748802SC5-YG-PG4-BZ
CONTACT PLATING IN MATING AREA	PART NUMBER

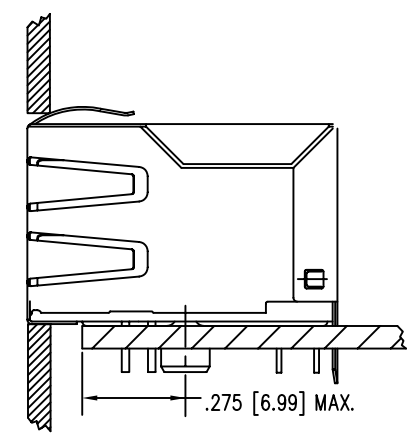
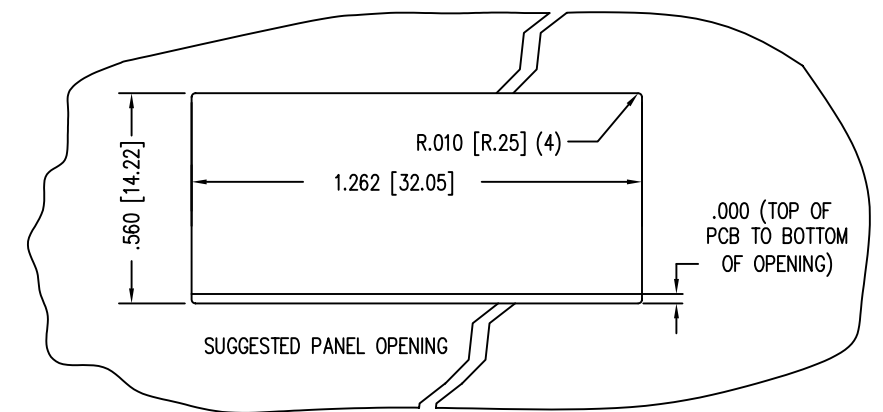

THIRD ANGLE PROJECTION  
DO NOT SCALE DRAWING  
DRAWING IS SUBJECT TO CHANGE WITHOUT NOTICE  
DIMENSIONS: INCHES [METRIC]  
UNLESS OTHERWISE SPECIFIED TOLERANCES ARE ±.005 [0.13] ANGLES ARE ± 1°  
SHEET NO. 1 OF 1

## Bel Stewart Connector

11118 Susquehanna Trail South  
Glen Rock, PA 17327-9199  
(717) 235-7512 Fax: (717) 235-7954 <http://www.stewartconnector.com>

**TITLE:** EIGHT CONTACT, EIGHT POSITION EMI-RFI ONE PIECE SHIELDED ESD GROUNDED 2 PORT PCB HARMONICA CAT 5 LED JACK PAC

DRN BY:	DHG	DATE	1-13-03
APPD BY:	RGC	DATE	1-14-03
DWG NO.	CT740116	REV.	A4

THIS DRAWING AND THE SUBJECT MATTER SHOWN THEREON ARE CONFIDENTIAL AND THE PROPRIETARY PROPERTY OF BEL STEWART CONNECTOR AND SHALL NOT BE REPRODUCED, COPIED, OR USED IN ANY MANNER WITHOUT PRIOR WRITTEN CONSENT OF BEL STEWART CONNECTOR. THE SUBJECT MATTER MAY BE PATENTED OR A PATENT MAY BE PENDING.

REV. 7/3/03