



Package Type : SOT-89

## Product Features

- 50ohm, 30 ~ 3000MHz
- GaAs E-pHEMT MMIC
- High linearity
- Low Noise Figure
- High productivity
- Low manufacturing cost
- Pb Free / RoHS Standard

## Applications

- Cellular, GSM
- PCS, DCS, W-CDMA
- Wibro, WiMax, WiFi
- Tetra, CATV, Satellite system
- RFID, Femtocell
- Multi-metering

## Description

AE410 is a drive or pre-drive amplifier designed in a low cost SOT-89 package.

This MMIC is based on Gallium Arsenide Enhancement Mode pHEMT which shows low current and high IP3.

It is designed as driver devices for infrastructure equipment in the 30~3000MHz Wireless technologies such as Cellular, GSM, PCS, W-CDMA, Wibro, WiMax System.

The data in this spec sheet is valid only for 50ohm application.

## Electrical Specifications

PARAMETER	UNIT	MIN	TYP	MAX	Remark
Frequency Range	MHz	30	-	3000	-
Gain	dB	19	20	-	@ 900MHz
Input Return Loss	dB	-	-13	-	-
Output Return Loss	dB	-	-13	-	-
Output IP3	dBm	32	34	-	@ 900MHz
1dB Compression Point	dBm	-	20	-	
Noise Figure	dB	-	2.3	-	-
DC Current	mA	-	100	-	-
Supply Voltage	V	-	5	-	-

### Note

1. Test conditions unless otherwise noted. Freq = At 900MHz, Vdd=+5V, T=25 °C, 50Ω system
2. OIP3 measured with 2 tones at an output power of +5dBm/tone separated by 1MHz

## Absolute Maximum Ratings

PARAMETER	UNIT	MIN	TYP	MAX	REMARK
Device Voltage	V	-	5	7	-
Operating Case Temperature	°C	-40	-	85	-
Storage Temperature	°C	-40	-	150	-
ESD Human Body Model	-	-	Class 1A	-	-
Moisture Sensitivity Level	-	-	MSL1	-	-
Junction Temperature (Tj)	°C	-	-	180	@ quiescent current, No RF, Tc = 85 °C
Thermal Resistance (Rth)	°C/W	-	70	-	

Application Circuit @ 50 ~ 3000MHz, 50ohm System

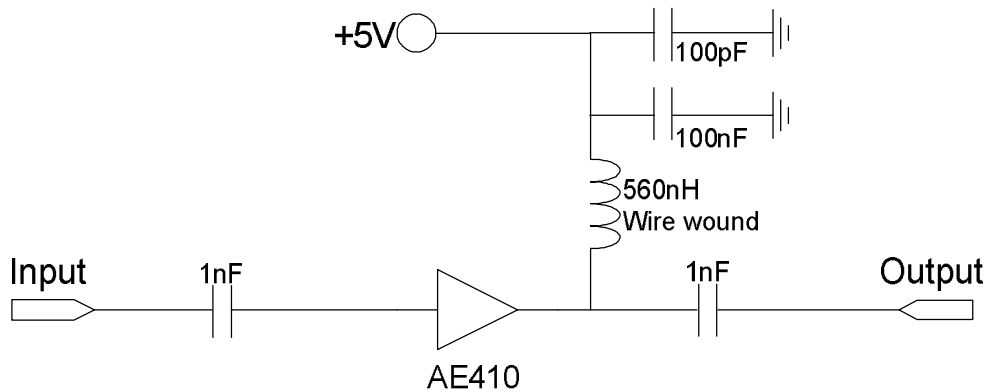

Typical RF Performance @  $V_{DD}=5V$ ,  $I_{DS}=100mA$ ,  $T=25^{\circ}C$ , 50ohm System

S-parameter

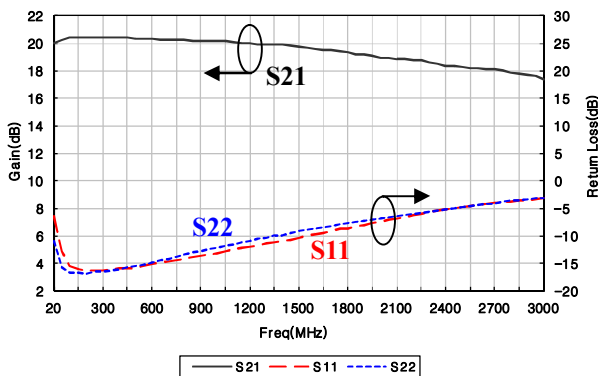

Noise Figure vs. Frequency

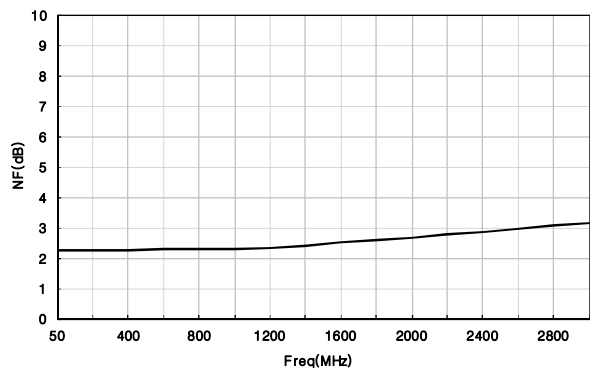

OIP3 vs. Frequency

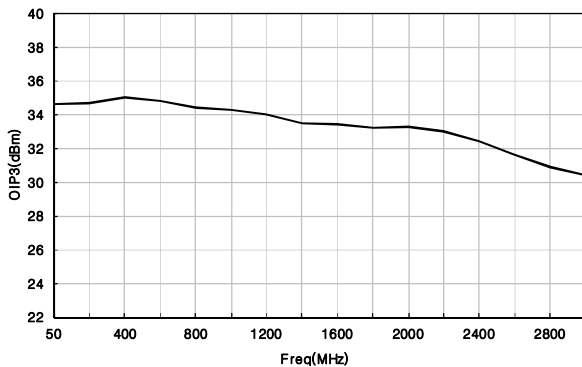

P1dB vs. Frequency

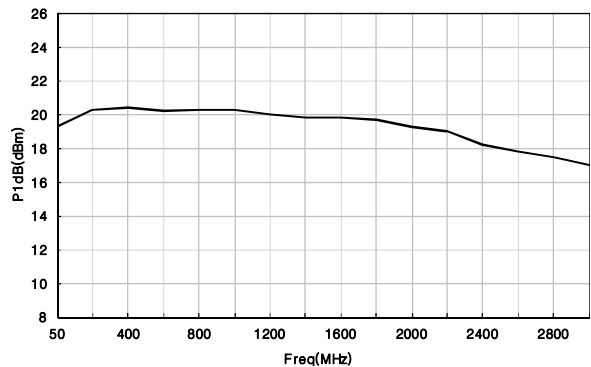

Application Circuit @ 1900 ~ 2200MHz, 50ohm System

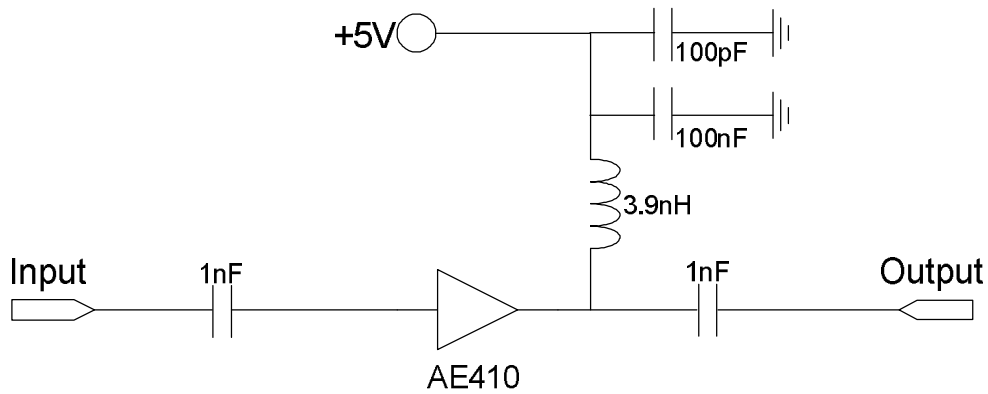

Typical RF Performance @  $V_{DD}=5V$ ,  $I_{DS}=100mA$ ,  $T=25^{\circ}C$ , 50ohm System

S-parameter

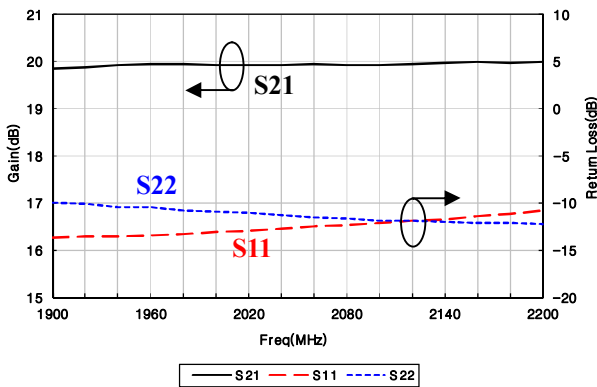

Noise Figure vs. Frequency

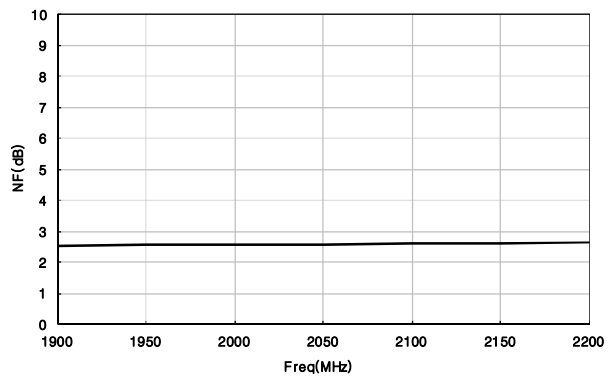

OIP3 vs. Frequency

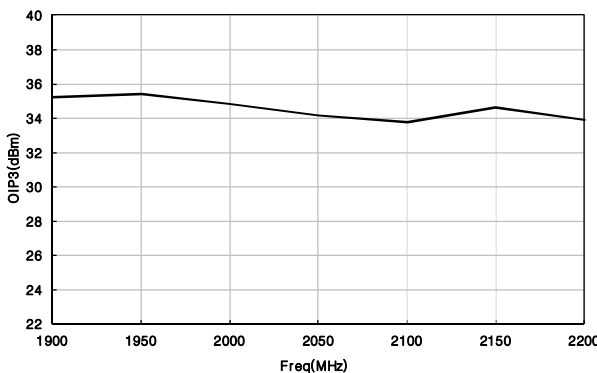

P1dB vs. Frequency

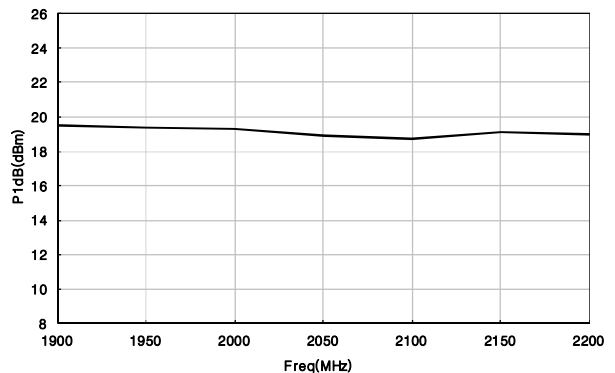

Temperature Test @ -40°C ~ +85°C, 50ohm System

Temperature Cycle

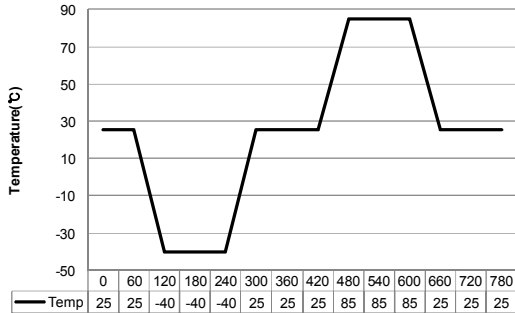

Temperature Range: Current

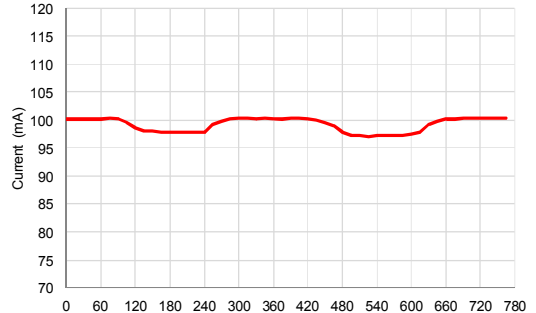

Temperature Range: Gain

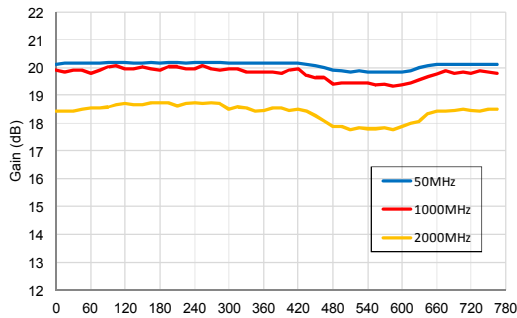

Temperature Range: Noise Figure

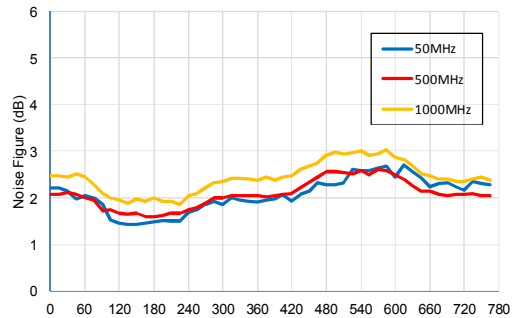

Temperature Range: Input Return Loss

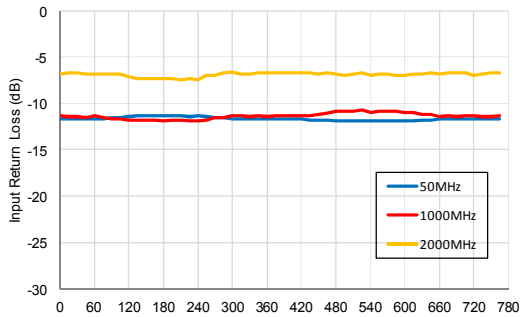

Temperature Range: Output Return Loss

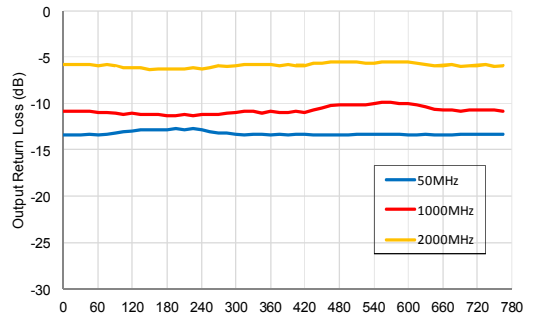

Temperature Range: OIP3

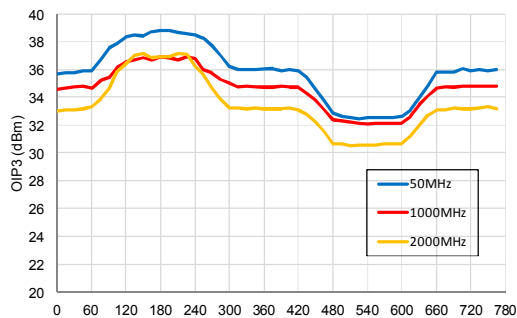

Temperature Range: P1dB

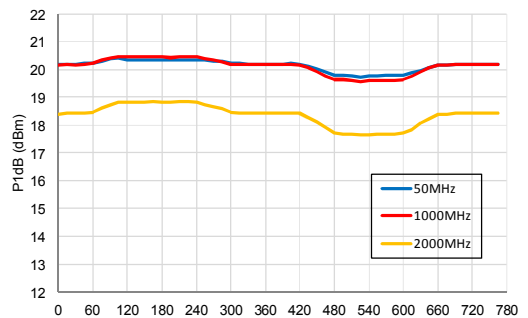

Package Dimensions (Type: SOT-89)

\* Unit: mm[inch] | Tolerance ±0.1[.004]

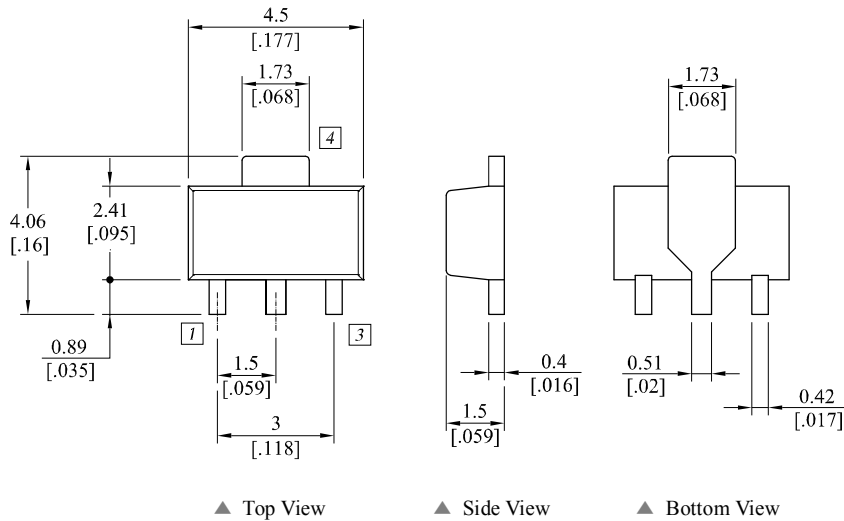

Pin Description			
Pin No	Function	Pin No	Function
1	Input	4	GND
2	GND	-	-
3	Output / Bias	-	-

Recommended Pattern

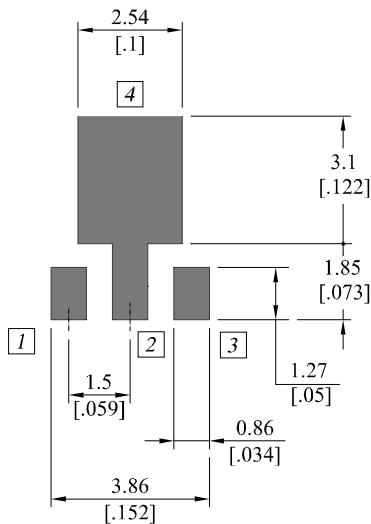

Recommended Mounting Configuration

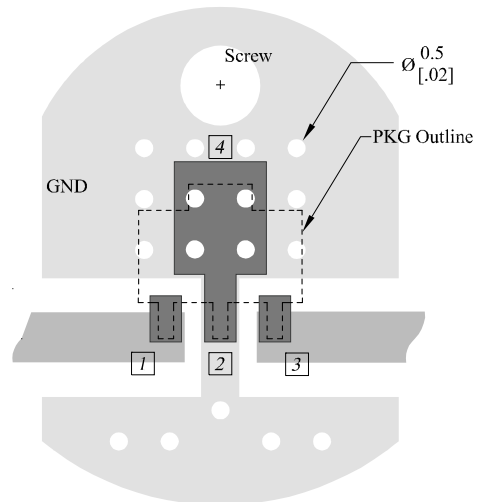

\* Mounting Configuration Notes

1. Ground / thermal via holes are critical for the proper performance of this device.
2. Add as much copper as possible to inner and outer layers near the part to ensure optimal thermal performance.
3. Mounting screws can be added near the part to fasten the board to a heatsink. Ensure that the ground / thermal via hole region contacts the heatsink.
4. Do not put solder mask on the backside of the PCB in the region where the board contacts the heatsink.
5. RF trace width depends upon the PCB material and construction.
6. Use 1 oz. Copper minimum.

**Revision History**

Part Number	Release Date	Version	Modification	Data Sheet Status
AE410	2012.12.04	1.1	Revision : Absolute Maximum Ratings	-
AE410	2012.12.04	1.0	Added Temperature Data	-
AE410	2012.09.07	0.1	Initial Release	Preliminary

RFHIC Corporation reserves the right to make changes to any products herein or to discontinue any product at any time without notice. While product specifications have been thoroughly examined for reliability, RFHIC Corporation strongly recommends buyers to verify that the information they are using is accurate before ordering. RFHIC Corporation does not assume any liability for the suitability of its products for any particular purpose, and disclaims any and all liability, including without limitation consequential or incidental damages. RFHIC products are not intended for use in life support equipment or application where malfunction of the product can be expected to result in personal injury or death. Buyer uses or sells such products for any such unintended or unauthorized application, buyer shall indemnify, protect and hold RFHIC Corporation and its directors, officers, stockholders, employees, representatives and distributors harmless against any and all claims arising out of such unauthorized use.

Sales, inquiries and support should be directed to the local authorized geographic distributor for RFHIC Corporation. For customers in the US, please contact the US Sales Team at 919-677-8780. For all other inquiries, please contact the International Sales Team at 82-31-250-5078