



LIGHTING FOREVER

4 PIN ULTRA SMALL SOP PHOTOTRANSISTOR PHOTOCOUPLER

EL357N-G Series

Features:

- Halogens free
- Current transfer ratio
(CTR: 50~600% at $I_F = 5\text{mA}$, $V_{CE} = 5\text{V}$)
- High isolation voltage between input and output ($V_{iso} = 3750\text{ V rms}$)
- Compact 4 Pin SOP with a 2.0 mm profile
- Pb free and RoHS compliant.
- UL approved (No. E214129)
- VDE approved (No. 132249)
- SEMKO approved
- NEMKO approved
- DEMKO approved
- FIMKO approved
- CSA approved (No. 1408633)

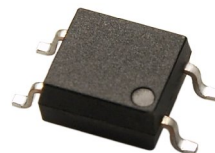

Schematic

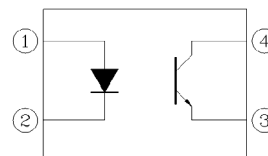

Description

The EL357N-G series contains an infrared emitting diode, optically coupled to a phototransistor detector.

The devices in a 4-pin small outline SMD package.

Pin Configuration

1. Anode
2. Cathode
3. Emitter
4. Collector

Applications

- DC-DC Converters
- Programmable controllers
- Telecommunication equipments
- Signal transmission between circuits of different potentials and impedances

CONFIDENTIAL



LIGHTING FOREVER

4 PIN ULTRA SMALL SOP PHOTOTRANSISTOR PHOTOCOUPLER

EL357N-G Series

Absolute Maximum Ratings (T_a=25°C)

Parameter		Symbol	Rating	Unit
Input	Forward current	I _F	50	mA
	Peak forward current (1us, pulse)	I _{FP}	1	A
	Reverse voltage	V _R	6	V
	Power dissipation Derating factor (about Ta=100°C)	P _D	70	mW
			2.9	mW/°C
Output	Power dissipation Derating factor (about Ta=80°C)	P _C	150	mW
			3.7	mW/°C
	Collector current	I _C	50	mA
	Collector-Emitter voltage	V _{CEO}	80	V
	Emitter-Collector voltage	V _{ECO}	7	V
Total power dissipation		P _{TOT}	200	mW
Isolation voltage *1		V _{ISO}	3750	V rms
Operating temperature		T _{OPR}	-55 ~ +110	°C
Storage temperature		T _{STG}	-55 ~ +125	°C
Soldering temperature *2		T _{SOL}	260	°C

Notes

*1 AC for 1 minute, R.H.= 40 ~ 60% R.H. In this test, pins 1 & 2 are shorted together, and pins 3 & 4 are shorted together.

*2 For 10 seconds.



LIGHTING FOREVER

4 PIN ULTRA SMALL SOP PHOTOTRANSISTOR PHOTOCOUPLER

EL357N-G Series

Electrical Characteristics (T_a=25°C unless specified otherwise)

Input

Parameter	Symbol	Min.	Typ.*	Max.	Unit	Condition
Forward voltage	V _F	-	1.2	1.4	V	I _F = 20mA
Reverse current	I _R	-	-	10	μA	V _R = 4V
Input capacitance	C _{in}	-	30	250	pF	V = 0, f = 1kHz

Output

Parameter	Symbol	Min.	Typ.*	Max.	Unit	Condition
Collector-Emitter dark current	I _{CEO}	-	-	100	nA	V _{CE} = 20V, I _F = 0mA
Collector-Emitter breakdown voltage	BV _{CEO}	80	-	-	V	I _C = 0.1mA
Emitter-Collector breakdown voltage	BV _{ECO}	7	-	-	V	I _E = 0.01mA

Transfer Characteristics (T_a=25°C unless specified otherwise)

Parameter	Symbol	Min.	Typ.*	Max.	Unit	Condition
Current Transfer ratio	EL357N	50	-	600	%	I _F = 5mA, V _{CE} = 5V
	EL357NA	80	-	160		
	EL357NB	130	-	260		
	EL357NC	200	-	400		
	EL357ND	300	-	600		
	EL357NE	100	-	200		
	EL357NF	150	-	300		
Collector-Emitter saturation voltage	V _{CE(sat)}	-	0.1	0.2	V	I _F = 20mA, I _C = 1mA
Isolation resistance	R _{IO}	5×10 ¹⁰	-	-	Ω	V _{IO} = 500Vdc, 40~60% R.H.
Floating capacitance	C _{IO}	-	0.6	1.0	pF	V _{IO} = 0, f = 1MHz
Cut-off frequency	f _c	-	80	-	kHz	V _{CE} = 5V, I _C = 2mA R _L = 100Ω, -3dB
Rise time	t _r	-	3	18	μs	V _{CE} = 2V, I _C = 2mA, R _L = 100Ω
Fall time	t _f	-	4	18	μs	

* Typical values at T_a = 25°C

4 PIN ULTRA SMALL SOP PHOTOTRANSISTOR PHOTOCOUPLER

EL357N-G Series

Typical Performance Curves

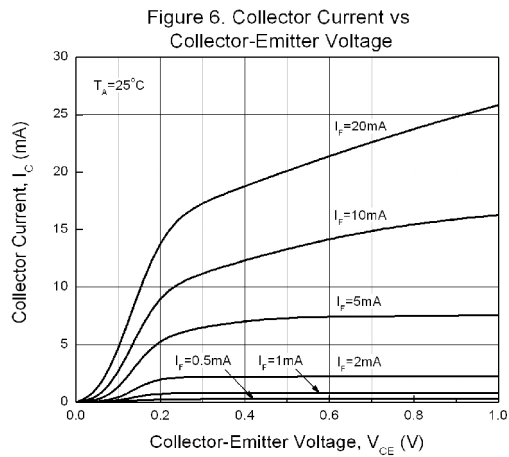
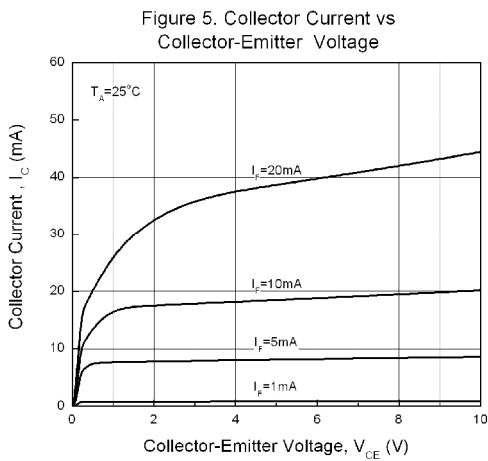
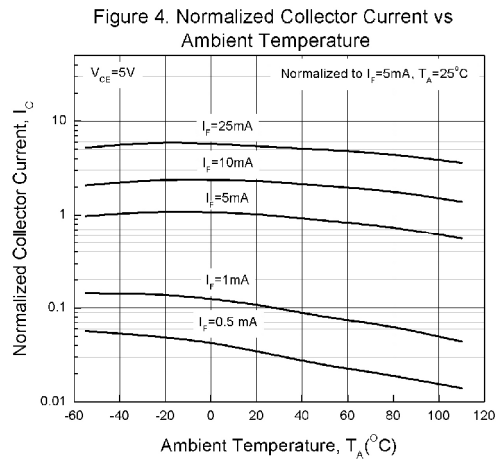
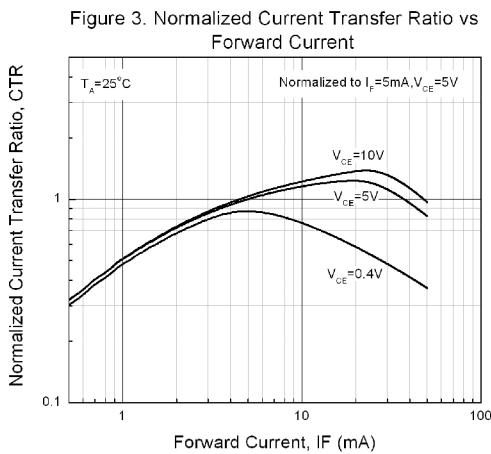
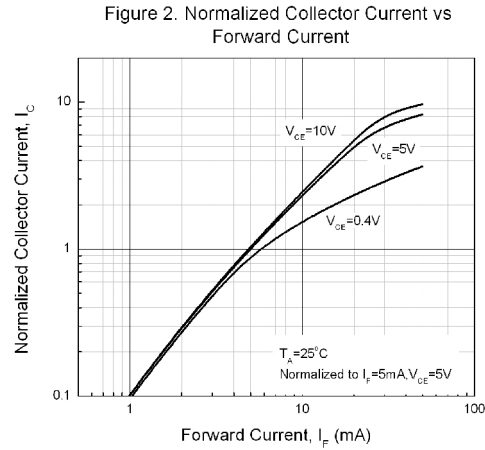
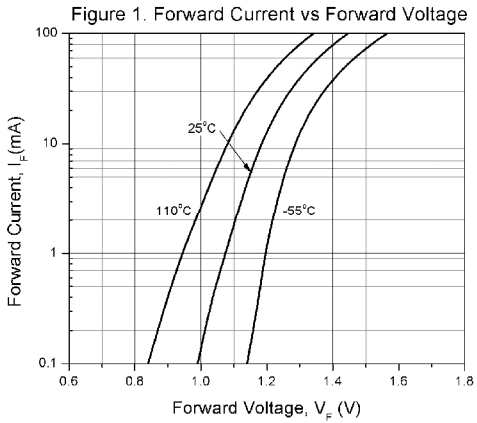

4 PIN ULTRA SMALL SOP PHOTOTRANSISTOR PHOTOCOUPLER

EL357N-G Series

Figure 7. Collector Dark Current vs Ambient Temperature

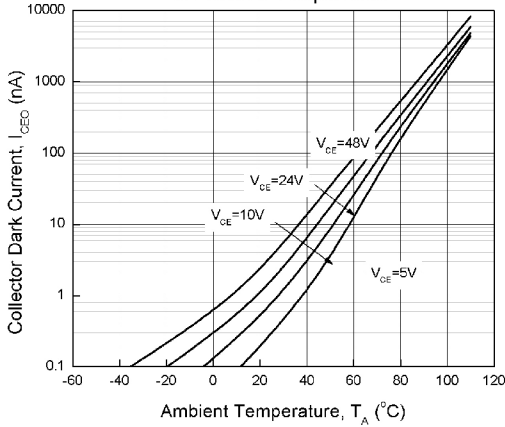

Figure 8. Switching Time vs Load Resistance

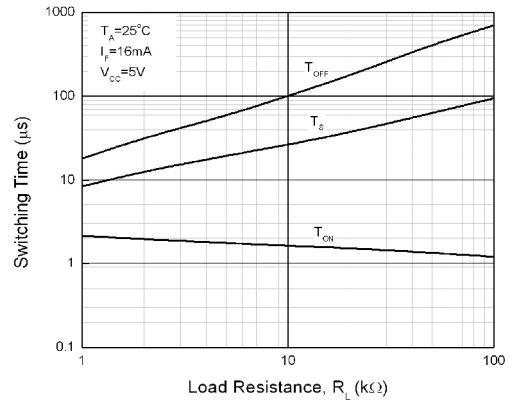
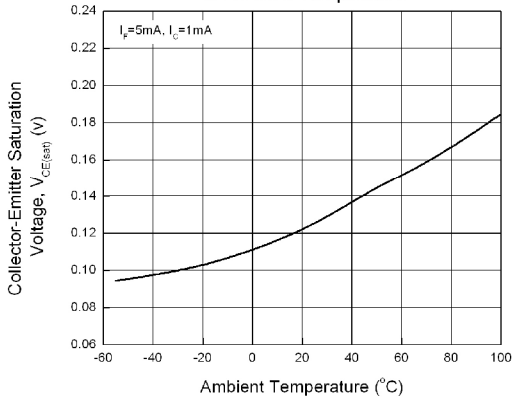

Figure 9. Collector-Emitter Saturation Voltage vs Ambient Temperature



IDENTENTIAL

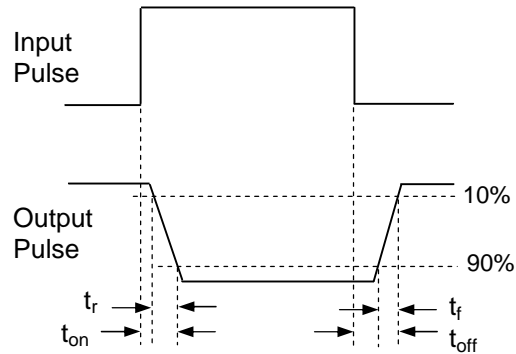
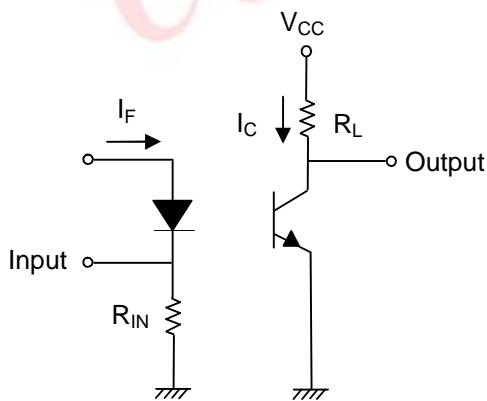

Figure 10. Switching Time Test Circuit & Waveforms



LIGHTING FOREVER

4 PIN ULTRA SMALL SOP PHOTOTRANSISTOR PHOTOCOUPLER

EL357N-G Series

Order Information

Part Number

EL357NX(Y)-VG

Note

- 357N = Part No.
- X = CTR Rank (A, B, C, D, E, For none)
- Y = Tape and reel option (TA, TB or none).
- V = VDE (optional)
- G = Halogen free

Option	Description	Packing quantity
None	Standard SMD option	100 units per tube
-V	Standard SMD option + VDE	100 units per tube
(TA)	TA Tape & reel option	3000 units per reel
(TB)	TB Tape & reel option	3000 units per reel
(TA)-V	TA Tape & reel option + VDE	3000 units per reel
(TB)-V	TB Tape & reel option + VDE	3000 units per reel

CONFIDENTIAL



LIGHTING FOREVER

4 PIN ULTRA SMALL SOP PHOTOTRANSISTOR PHOTOCOUPLER

EL357N-G Series

Package Drawing
(Dimensions in mm)

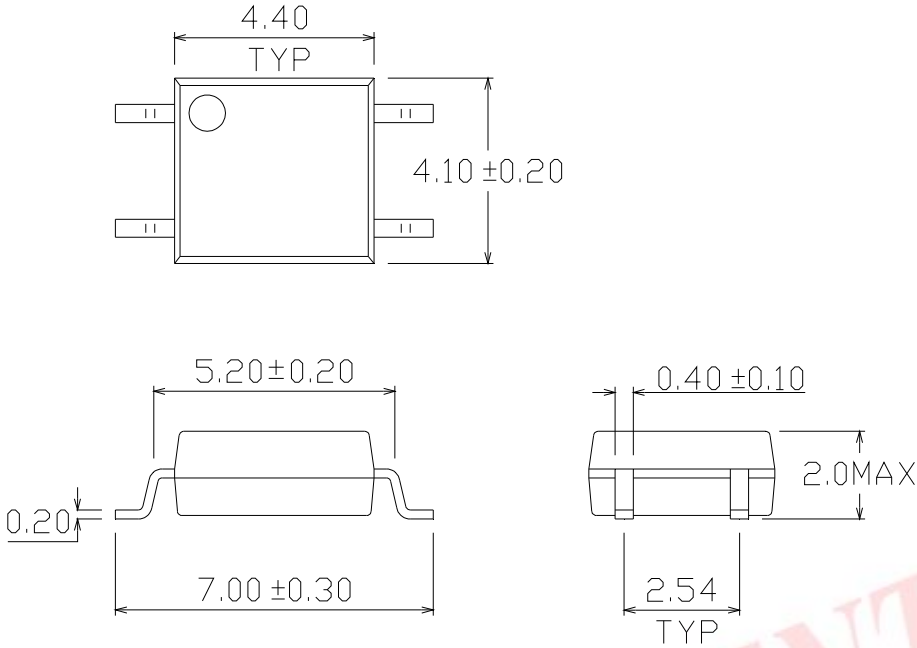

Recommended pad layout for surface mount leadform

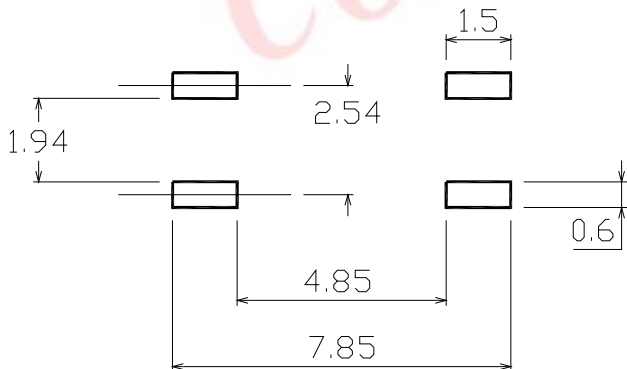



LIGHTING FOREVER

4 PIN ULTRA SMALL SOP PHOTOTRANSISTOR PHOTOCOUPLER

EL357N-G Series

Device Marking



Notes

EL	denotes Everlight
357N	denotes Device Number
R	denotes CTR Rank (A, B, C, D, E, F or none)
Y	denotes 1 digit Year code
WW	denotes 2 digit Week code
V	denotes VDE (optional)

CONFIDENTIAL



LIGHTING FOREVER

4 PIN ULTRA SMALL SOP PHOTOTRANSISTOR PHOTOCOUPLER

EL357N-G Series

Tape & Reel Packing Specifications

Option TA

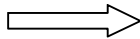
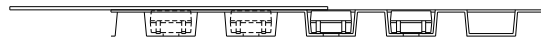
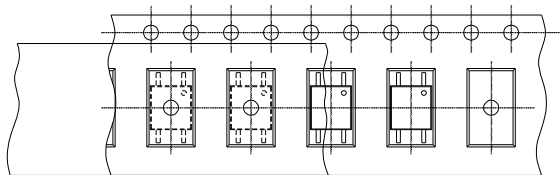

Direction of feed from reel

Option TB

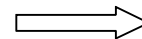
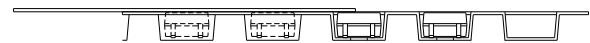
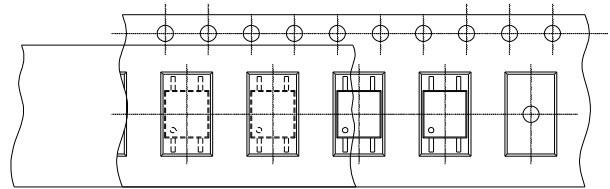

Direction of feed from reel

Tape dimensions

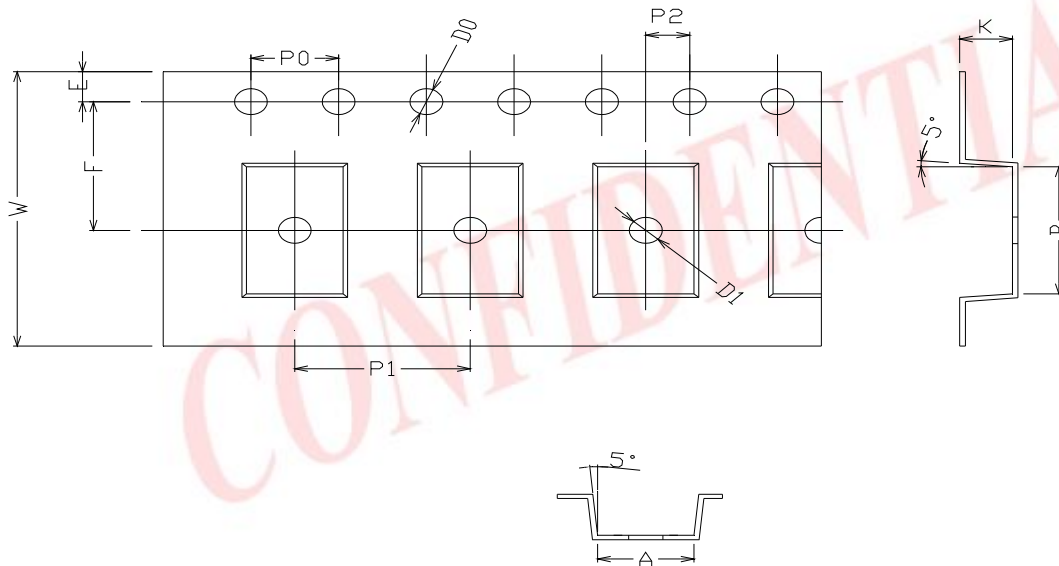

Dimension No.	A	B	Do	D1	E	F
Dimension (mm)	4.4 ± 0.1	7.4 ± 0.1	1.5 + 0.1/-0	1.5 ± 0.1	1.7 5± 0.1	7.5 ± 0.1
Dimension No.	Po	P1	P2	t	W	K
Dimension (mm)	4.0 ± 0.15	8.0 ± 0.1	2.0 ± 0.1	0.25 ± 0.03	16.0 ± 0.2	2.4 ± 0.1



LIGHTING FOREVER

4 PIN ULTRA SMALL SOP PHOTOTRANSISTOR PHOTOCOUPLER

EL357N-G Series

Solder Reflow Temperature Profile

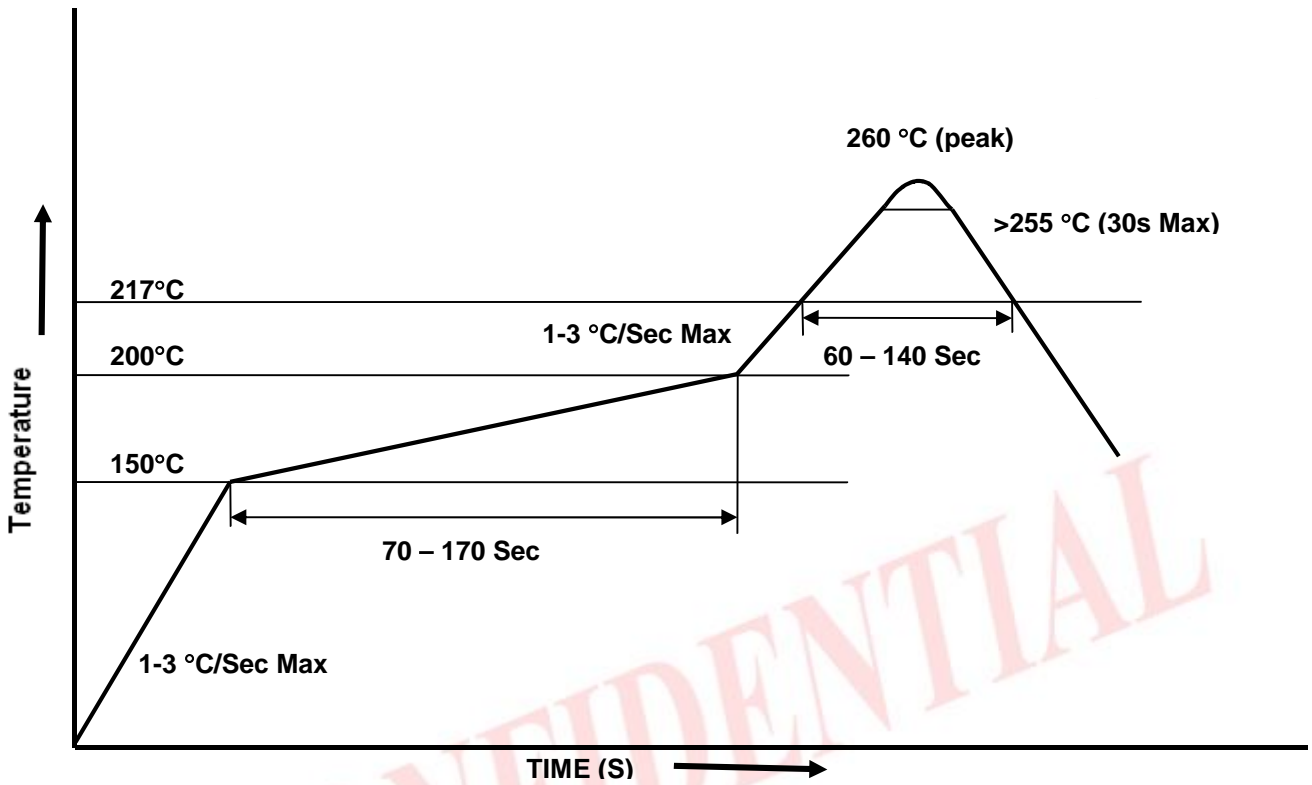

CONFIDENTIAL



LIGHTING FOREVER

4 PIN ULTRA SMALL SOP PHOTOTRANSISTOR PHOTOCOUPLER

EL357N-G Series

DISCLAIMER

1. The specifications in this datasheet may be changed without notice. EVERLIGHT reserves the authority on material change for above specification.
2. When using this product, please observe the absolute maximum ratings and the instructions for use as outlined in this datasheet. EVERLIGHT assumes no responsibility for any damage resulting from use of the product which does not comply with the absolute maximum ratings and the instructions included in this datasheet.
3. These specification sheets include materials protected under copyright of EVERLIGHT. Reproduction in any form is prohibited without the specific consent of EVERLIGHT.

CONFIDENTIAL