

TrenchMV™ Power MOSFET

IXTV200N10T IXTV200N10TS

$$V_{DSS} = 100V$$

$$I_{D25} = 200A$$

$$R_{DS(on)} \leq 5.5m\Omega$$

N-Channel Enhancement Mode
Avalanche Rated



Symbol	Test Conditions	Maximum Ratings	
V_{DSS}	$T_J = 25^\circ C$ to $175^\circ C$	100	V
V_{DGR}	$T_J = 25^\circ C$ to $175^\circ C$, $R_{GS} = 1M\Omega$	100	V
V_{GSM}	Transient	± 30	V
I_{D25}	$T_C = 25^\circ C$	200	A
I_{LRMS}	Lead Current Limit, RMS	75	A
I_{DM}	$T_C = 25^\circ C$, pulse width limited by T_{JM}	500	A
I_A	$T_C = 25^\circ C$	40	A
E_{AS}	$T_C = 25^\circ C$	1.5	J
P_D	$T_C = 25^\circ C$	550	W
T_J		-55 ... +175	$^\circ C$
T_{JM}		175	$^\circ C$
T_{stg}		-55 ... +175	$^\circ C$
T_L	1.6mm (0.062in.) from case for 10s Plastic body for 10 seconds	300 260	$^\circ C$ $^\circ C$
F_C	Mounting force (PLUS220)	11.65 / 2.5..14.6	N/lb.
Weight	PLUS220 types	4	g

PLUS220 (IXFV)

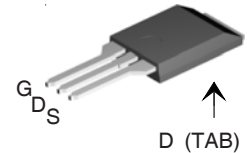

PLUS220SMD (IXFV_S)

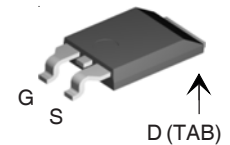

G = Gate D = Drain
S = Source TAB = Drain

Features

- International standard packages
- 175°C Operating Temperature
- Avalanche Rated
- Low $R_{DS(on)}$

Advantages

- Easy to mount
- Space savings
- High power density

Applications

- Automotive
 - Motor Drives
 - High Side Switch
 - 12V Battery
 - ABS Systems
- DC/DC Converters and Off-line UPS
- Primary - Side Switch
- High Current Switching Applications

Symbol	Test Conditions ($T_J = 25^\circ C$ unless otherwise specified)	Characteristic Values		
		Min.	Typ.	Max.
BV_{DSS}	$V_{GS} = 0V$, $I_D = 250\mu A$	100		V
$V_{GS(th)}$	$V_{DS} = V_{GS}$, $I_D = 250\mu A$	2.5		4.5 V
I_{GSS}	$V_{GS} = \pm 20V$, $V_{DS} = 0V$			± 200 nA
I_{DSS}	$V_{DS} = V_{DSS}$			5 μA
	$V_{GS} = 0V$ $T_J = 150^\circ C$			250 μA
$R_{DS(on)}$	$V_{GS} = 10V$, $I_D = 50A$, Notes 1, 2	4.5	5.5	m Ω

Symbol	Test Conditions ($T_J = 25^\circ\text{C}$, unless otherwise specified)	Characteristic Values		
		Min.	Typ.	Max.
g_{fs}	$V_{DS} = 10\text{V}$, $I_D = 60\text{A}$, Note 1	60	96	S
C_{iss}	$V_{GS} = 0\text{V}$, $V_{DS} = 25\text{V}$, $f = 1\text{MHz}$		9400	pF
C_{oss}			1087	pF
C_{rss}			140	pF
$t_{d(on)}$	Resistive Switching Times $V_{GS} = 10\text{V}$, $V_{DS} = 0.5 \cdot V_{DSS}$, $I_D = 50\text{A}$ $R_G = 3.3\Omega$ (External)		35	ns
t_r			31	ns
$t_{d(off)}$			45	ns
t_f			34	ns
$Q_{g(on)}$	$V_{GS} = 10\text{V}$, $V_{DS} = 0.5 \cdot V_{DSS}$, $I_D = 50\text{A}$		152	nC
Q_{gs}			47	nC
Q_{gd}			47	nC
R_{thJC}			0.27	$^\circ\text{C/W}$
R_{thCH}	PLUS220	0.21		$^\circ\text{C/W}$

Source-Drain Diode

Symbol	Test Conditions ($T_J = 25^\circ\text{C}$, unless otherwise specified)	Characteristic Values		
		Min.	Typ.	Max.
I_S	$V_{GS} = 0\text{V}$			200 A
I_{SM}	Repetitive, Pulse width limited by T_{JM}			500 A
V_{SD}	$I_F = 50\text{A}$, $V_{GS} = 0\text{V}$, Note 1			1.0 V
t_{rr}	$I_F = 100\text{A}$, $V_{GS} = 0\text{V}$, $-di/dt = 100\text{A}/\mu\text{s}$ $V_R = 50\text{V}$		76	ns
Q_{RM}			205	nC
I_{RM}			5.4	A

- Notes: 1. Pulse test, $t \leq 300\mu\text{s}$; duty cycle, $d \leq 2\%$.
2. On through-hole packages, $R_{DS(on)}$ Kelvin test contact location must be 5mm or less from the package body.

PLUS220 (IXTV) Outline

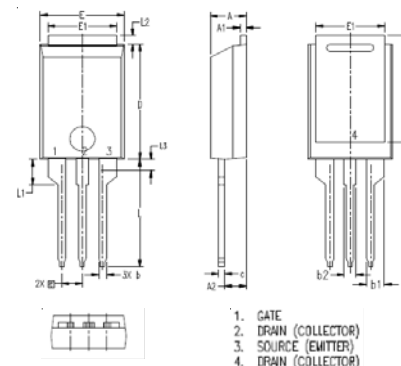

SYM	INCHES		MILLIMETER	
	MIN	MAX	MIN	MAX
A	.169	.185	4.30	4.70
A1	.028	.035	0.70	0.90
A2	.098	.118	2.50	3.00
b	.035	.047	0.90	1.20
b1	.080	.095	2.03	2.41
b2	.054	.064	1.37	1.63
c	.028	.035	0.70	0.90
D	.551	.591	14.00	15.00
D1	.512	.539	13.00	13.70
E	.394	.433	10.00	11.00
E1	.331	.346	8.40	8.80
e	.100 BSC		2.54 BSC	
L	.512	.551	13.00	14.00
L1	.118	.138	3.00	3.50
L2	.035	.051	0.90	1.30
L3	.047	.059	1.20	1.50

PLUS220SMD (IXTV_S) Outline

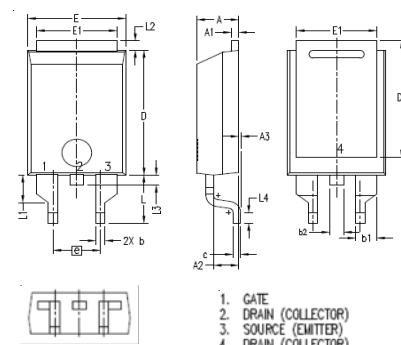

SYM	INCHES		MILLIMETER	
	MIN	MAX	MIN	MAX
A	.169	.185	4.30	4.70
A1	.028	.035	0.70	0.90
A2	.098	.118	2.50	3.00
A3	.000	.010	0.00	0.25
b	.035	.047	0.90	1.20
b1	.080	.095	2.03	2.41
b2	.054	.064	1.37	1.63
c	.028	.035	0.70	0.90
D	.551	.591	14.00	15.00
D1	.512	.539	13.00	13.70
E	.394	.433	10.00	11.00
E1	.331	.346	8.40	8.80
e	.200 BSC		5.08 BSC	
L	.209	.228	5.30	5.80
L1	.118	.138	3.00	3.50
L2	.035	.051	0.90	1.30
L3	.047	.059	1.20	1.50
L4	.039	.059	1.00	1.50

IXYS reserves the right to change limits, test conditions, and dimensions.

IXYS MOSFETs and IGBTs are covered by one or more of the following U.S. patents:	4,835,592	4,931,844	5,049,961	5,237,481	6,162,665	6,404,065 B1	6,683,344	6,727,585	7,005,734 B2	7,157,338B2
	4,850,072	5,017,508	5,063,307	5,381,025	6,259,123 B1	6,534,343	6,710,405 B2	6,759,692	7,063,975 B2	
	4,881,106	5,034,796	5,187,117	5,486,715	6,306,728 B1	6,583,505	6,710,463	6,771,478 B2	7,071,537	

Fig. 1. Output Characteristics @ 25°C

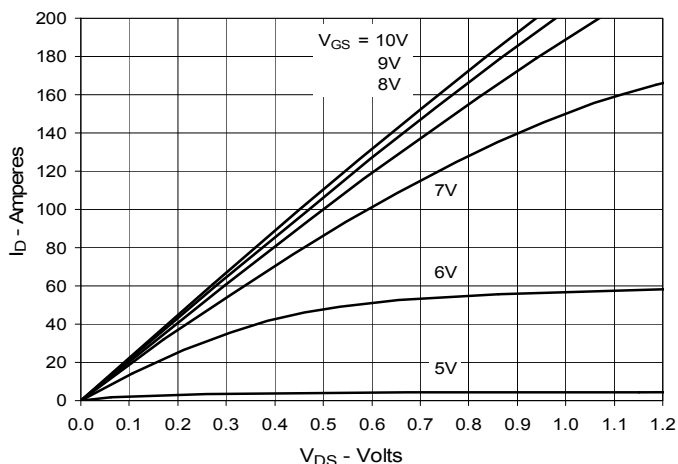

Fig. 2. Extended Output Characteristics @ 25°C

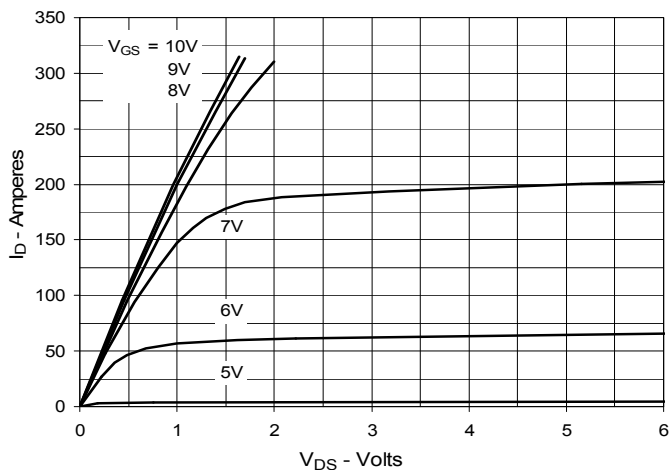

Fig. 3. Output Characteristics @ 150°C

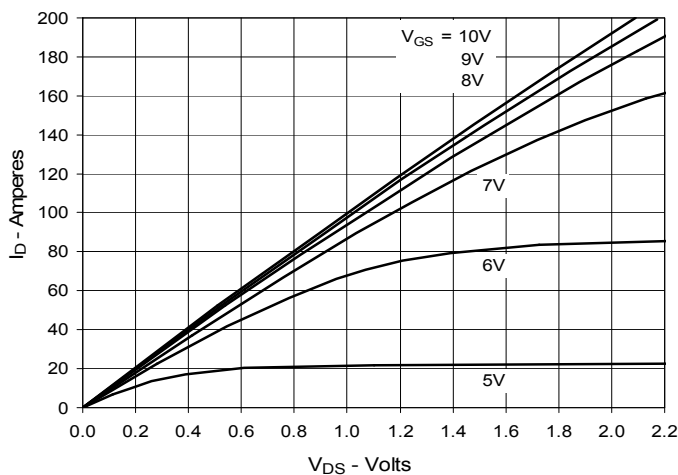

Fig. 4. $R_{DS(on)}$ Normalized to $I_D = 100A$ Value vs. Junction Temperature

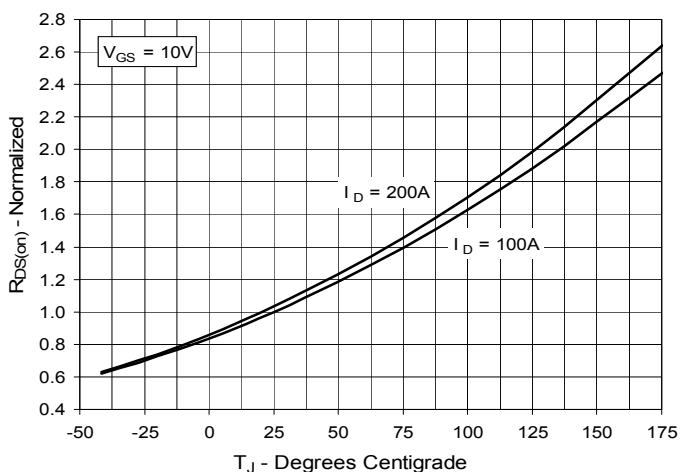

Fig. 5. $R_{DS(on)}$ Normalized to $I_D = 100A$ Value vs. Drain Current

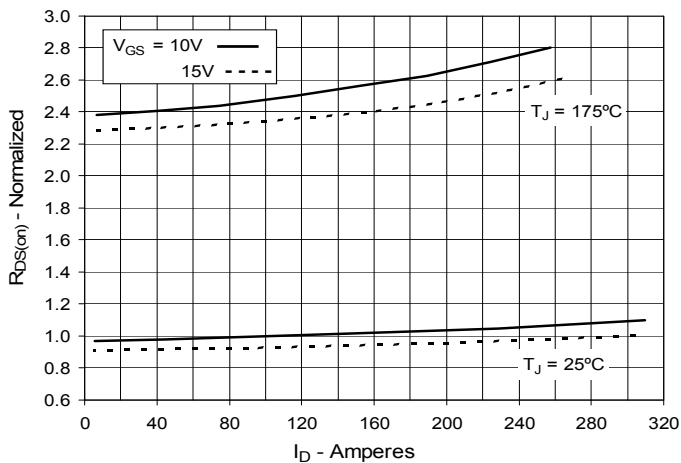

Fig. 6. Drain Current vs. Case Temperature

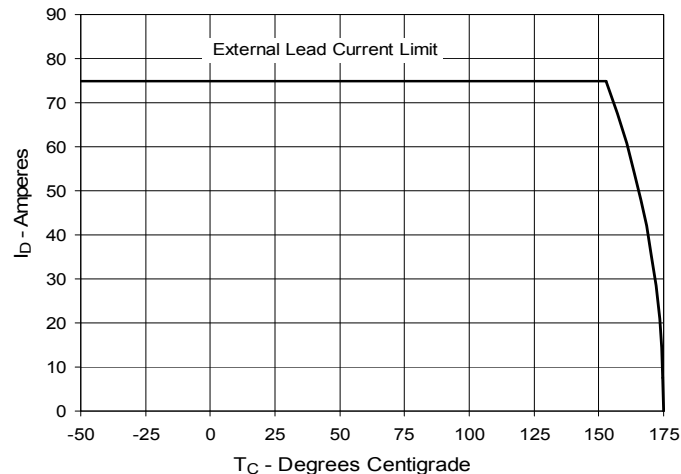

Fig. 7. Input Admittance

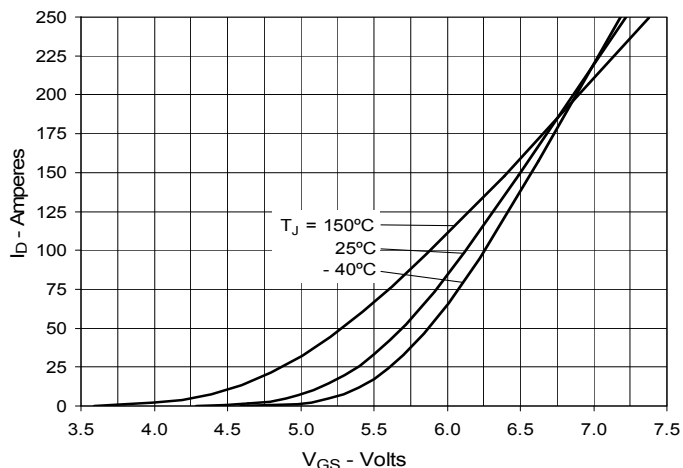

Fig. 8. Transconductance

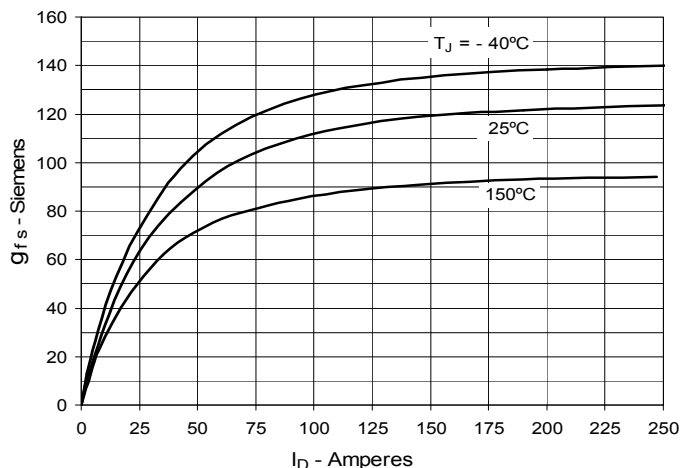

Fig. 9. Forward Voltage Drop of Intrinsic Diode

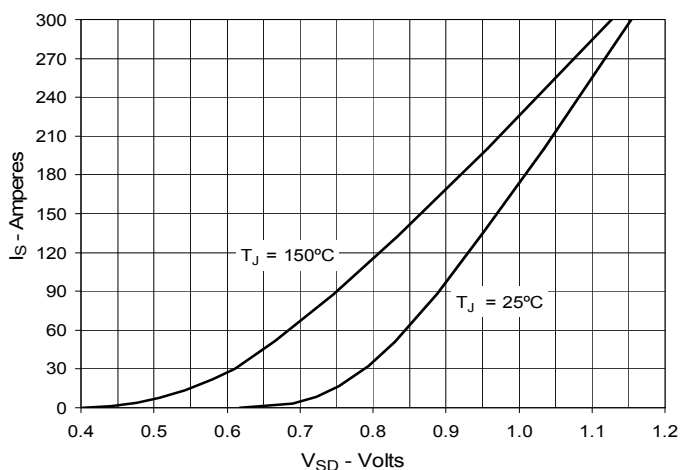

Fig. 10. Gate Charge

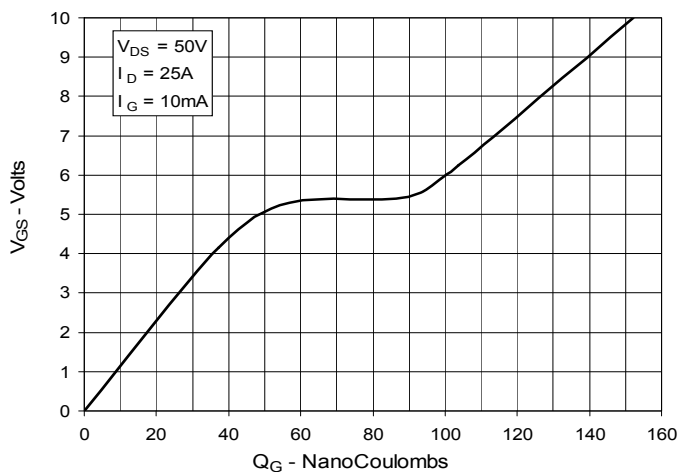

Fig. 11. Capacitance

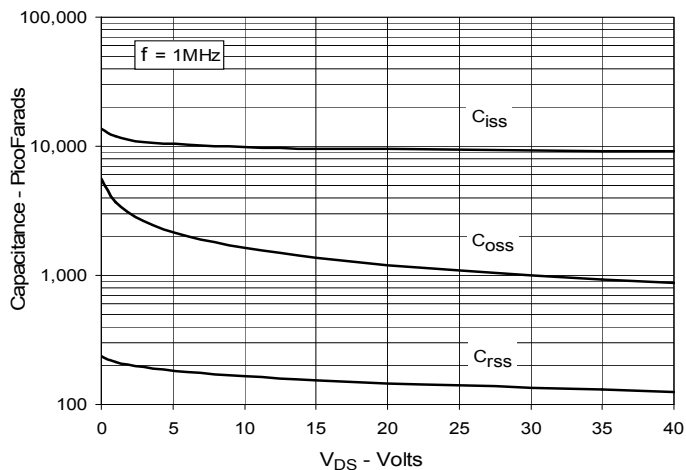
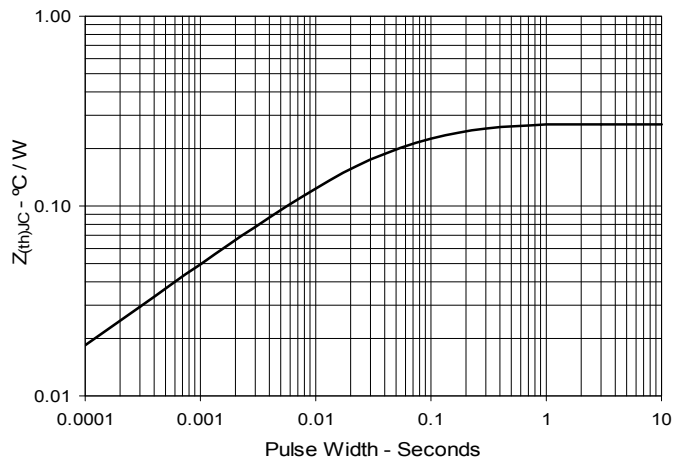
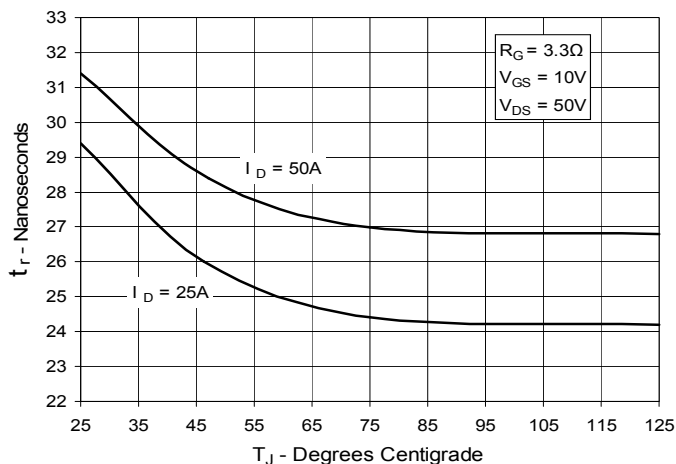

Fig. 12. Maximum Transient Thermal Impedance



IXYS reserves the right to change limits, test conditions, and dimensions.

**Fig. 13. Resistive Turn-on
Rise Time vs. Junction Temperature**



**Fig. 14. Resistive Turn-on
Rise Time vs. Drain Current**

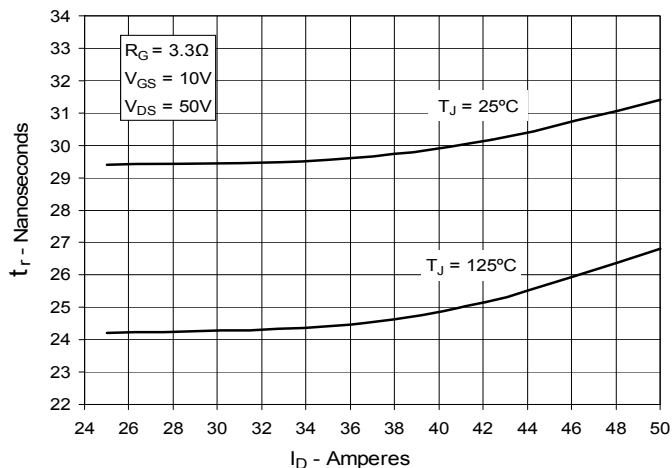

**Fig. 15. Resistive Turn-on
Switching Times vs. Gate Resistance**

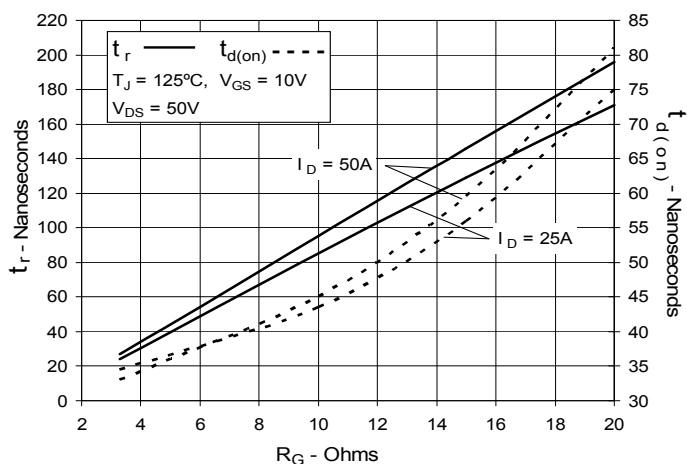

**Fig. 16. Resistive Turn-off
Switching Times vs. Junction Temperature**

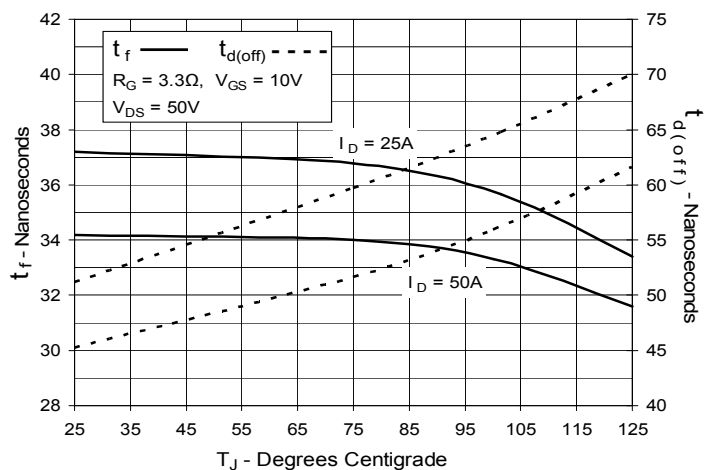

**Fig. 17. Resistive Turn-off
Switching Times vs. Drain Current**

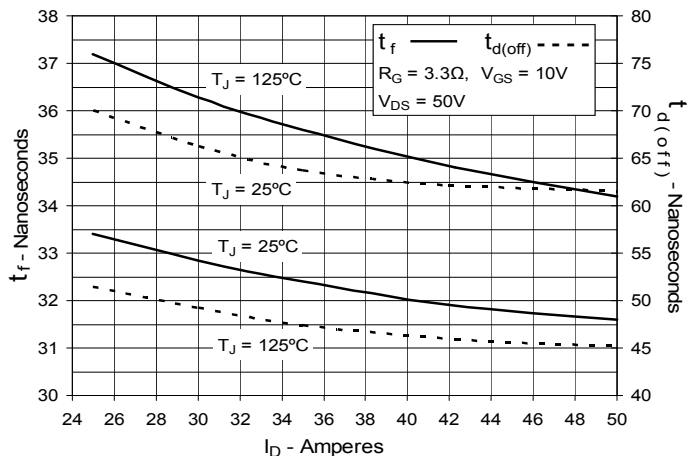

**Fig. 18. Resistive Turn-off
Switching Times vs. Gate Resistance**

