

MORNSUN®

MSA_(M)D-3W & MSB_(M)D-3W Series 3W, WIDE INPUT, ISOLATED & REGULATED DUAL/SINGLE OUTPUT DIP DC-DC CONVERTER

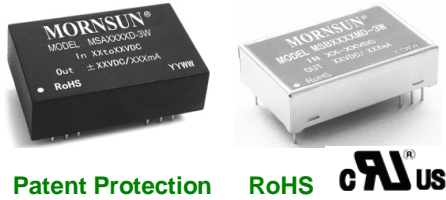

Patent Protection RoHS cULus

FEATURES

- 2:1 wide input range
- Efficiency up to 82%
- Operating temperature range:-40°C ~ +85°C
- 1.5KVDC isolation
- Short circuit protection(Automatic recovery)
- Low Temperature rise
- No external component required
- UL94-V0 package
- Industry standard pinout
- MTBF>1,000,000 hours

APPLICATIONS

The MSA_(M)D-3W & MSB_(M)D-3W series are designed for applications where the output power is directly introduced into the power control circuit board After the AC / DC converter filter circuit from a distributed power system. For these DC-DC converters, You can reduce the design point of failure and save the development of micro power supply's manpower, material and time costs, also better ensure product quality stability, protect safety and reliability of the end of products.

These products apply to where:

- 1) Input voltage variation ranges ≤ 2:1;
- 2) 1.5KVDC input and output isolation;
- 3) Regulated and low ripple noise are required.

PART NUMBER SYSTEM

MSA2405MD-3W

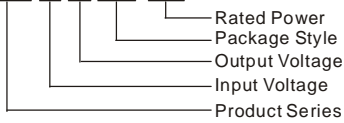

SELECTION GUIDE

Model Number	Input Voltage(VDC)		Output Voltage (VDC)	Output Current (mA)		Input Current (mA)(typ.)		Reflected Ripple Current (mA,typ.)	Max. Capacitive Load* (μF)	Efficiency (% , typ.) @Max. Load	Certificate		
	Nominal (Range)	Max*		Max.	Min.	@Max. Load	@No Load						
MSA0505(M)D-3W	5 (4.5-9)	11	±5	±300	±30	882	85	25	680	68			
MSA0512(M)D-3W			±12	±125	±12	833			330	72			
MSA0515(M)D-3W			±15	±100	±10	822			220	73			
MSB0505(M)D-3W			5 (4.5-9)	11	5	600	60	882	65	35	1000	68	
MSB0509D-3W					9	333	33	857			680	70	
MSB0512MD-3W					12	250	25	833			470	72	
MSB0515D-3W					15	200	20	822			330	73	
MSA1205MD-3W	12 (9-18)	22	±5	±300	±30	329	25	20	680	76			
MSA1212(M)D-3W			±12	±125	±12	316			330	79			
MSA1215(M)D-3W			±15	±100	±10	313			220	80			
MSB1205(M)D-3W			12 (9-18)	22	5	600	60	329	35	25	1000	76	
MSB1209MD-3W					9	333	33	321			680	78	
MSB1212(M)D-3W					12	250	25	313			470	80	
MSB1215(M)D-3W					15	200	20	309			330	81	
MSB1224(M)D-3W	24	125	12	305	220	82							
MSA2405(M)D-3W	24 (18-36)	40	±5	±300	±30	164	10	20	680	76			
MSA2409(M)D-3W			±9	±167	±16	160			470	78			
MSA2412(M)D-3W			±12	±125	±12	156			330	80			
MSA2415(M)D-3W			±15	±100	±10	154			220	81			
MSB2403(M)D-3W			24 (18-36)	40	3.3	909	90	169	15	30	2200	74	UL
MSB2405(M)D-3W					5	600	60	164			1000	76	UL
MSB2409(M)D-3W					9	333	33	160			680	78	UL
MSB2412(M)D-3W					12	250	25	154			470	81	UL
MSB2415(M)D-3W					15	200	20	156			330	80	UL
MSB2424(M)D-3W					24	125	12	152			220	82	UL

Model Number	Input Voltage(VDC)		Output Voltage (VDC)	Output Current (mA)		Input Current (mA)(typ.)		Reflected Ripple Current (mA,typ.)	Max. Capacitive Load [#] (μF)	Efficiency (% , typ.) @Max. Load	Certificate
	Nominal (Range)	Max*		Max.	Min.	@Max. Load	@No Load				
MSA4805(M)D-3W	48 (36-72)	80	±5	±300	±30	82	6	20	680	76	
MSA4812(M)D-3W			±12	±125	±12	78			330	80	
MSA4815(M)D-3W			±15	±100	±10	77			220	81	
MSB4803(M)D-3W			±3	909	90	84	8	25	2200	74	
MSB4805(M)D-3W			5	600	60	82			1000	76	
MSB4809(M)D-3W			9	333	33	80			680	78	
MSB4812(M)D-3W			12	250	25	77			470	81	
MSB4815D-3W			15	200	20	78			330	80	
MSB4824(M)D-3W			24	125	12	76			220	82	

Note: 1.*Input voltage can't exceed this value, or will cause the permanent damage.
2. Models listed with strike-through text have been officially discontinued.
3. # For each output.

INPUT SPECIFICATIONS

Item	Test Conditions	Min.	Typ.	Max.	Unit
Input Surge Voltage (1sec. max.)	5VDC input	-0.7	--	12	VDC
	12VDC input	-0.7	--	25	
	24VDC input	-0.7	--	50	
	48VDC input	-0.7	--	100	
Start-up Voltage	5VDC input	--	4.0	4.5	VDC
	12VDC input	--	8.5	9	
	24VDC input	--	17	18	
	48VDC input	--	34	36	
Short Circuit Input Power		--	1.5	2.5	W
Input Filter		π Filter			

OUTPUT SPECIFICATIONS

Item	Test Conditions	Min.	Typ.	Max.	Unit
Output Power		0.3	--	3	W
Positive voltage accuracy	Refer to recommended circuit	--	±1	±3	%
Negative voltage accuracy		--	±3	±5	
Output Voltage Balance	Dual Output, Balanced Loads	--	±0.5	±1	
Line Regulation	Input voltage from low to high	--	±0.2	±0.5	
Load Regulation	From10% to 100% load	--	±0.5	±1	
Transient Recovery Time	25% Load step change	--	6	15	ms
Transient Response Deviation		--	±3	±5	%
Temperature Drift	Refer to recommended circuit	--	--	±0.03	%/°C
Ripple & Noise*	20MHz Bandwidth	--	50	100	mVp-p
Short Circuit Protection		Continuous, automatic recovery			

Note: 1. Dual output models unbalanced load: ≤±5%.
2.*Ripple and noise tested by "parallel cable" method. See detailed operation instructions at Testing of Power Converter section, application notes.

COMMON SPECIFICATIONS

Item	Test Conditions	Min.	Typ.	Max.	Unit
Isolation Voltage	Tested for 1 minute and leakage current less than 1 mA	1500	--	--	VDC
Isolation Resistance	Test at 500VDC	1000	--	--	MΩ
Isolation Capacitance	Input/Output,100KHz/1V	--	80	--	pF
Switching Frequency	100% load, input voltage range	--	300	--	KHz
MTBF	MIL-HDBK-217F@25°C	1000	--	--	K hours
Case Material		D: Plastic(UL94-V0), MD:Stainless steel			
Weight		--	15	--	g

ENVIRONMENTAL SPECIFICATIONS

Item	Test Conditions	Min.	Typ.	Max.	Unit
Storage Humidity	Non condensing	--	--	95	%
Operating Temperature	Power derating (above 71°C)	-40	--	85	°C
Storage Temperature		-55	--	125	
Temp. rise at full load	Ta=25°C	--	15	--	
Soldering Temperature	1.5mm from case for 10 seconds	--	--	300	
Cooling		Free air convection			

EMC SPECIFICATIONS

EMI	CE	CISPR22/EN55022 CLASS A (External Circuit Refer to Figure1-②)
EMS	ESD	IEC/EN61000-4-2 Contact ±4KV perf. Criteria B
	EFT	IEC/EN61000-4-4 ±2KV perf. Criteria B (External Circuit Refer to Figure 1-①)
	Surge	IEC/EN61000-4-5 ±2KV perf. Criteria B (External Circuit Refer to Figure 1-①)

EMC RECOMMENDED CIRCUIT

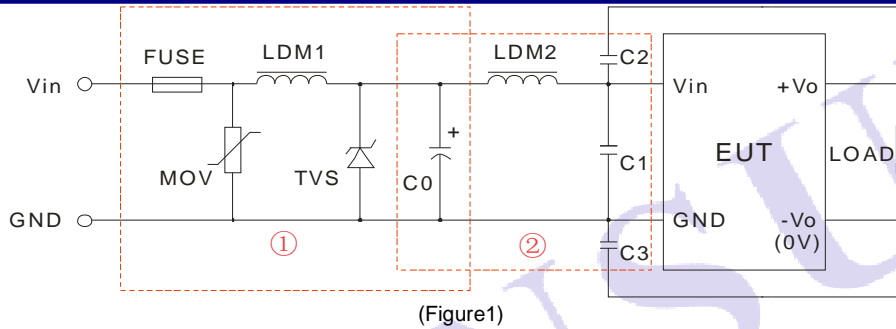

MSA_(M)D-3W Recommended external circuit parameters:

Model		Vin: 5V	Vin: 12V	Vin: 24V	Vin: 48V
EMS	FUSE	Choose according to practical input current			
	MOV	--	--	10D560K	10D101K
	LDM1	--	--	56μH	56μH
	TVS	SMCJ13A	SMCJ28A	SMCJ48A	SMCJ90A
	C0	680μF/16V	680μF/25V	120μF/50V	120μF/100V
EMI	C0	680μF/16V	--	--	--
	C1	--	4.7μF/50V	4.7μF/50V	4.7μF/100V
	C2	--	--	100pF/2KV (MSA24_D-3W) 1000pF/2KV (MSA24_MD-3W)	100pF/2KV (MSA48_D-3W)
	C3	--	--	--	100pF/2KV (MSA48_D-3W)

MSB_(M)D-3W Recommended external circuit parameters:

Model		Vin: 5V	Vin: 12V	Vin: 24V	Vin: 48V
EMS	FUSE	Choose according to practical input current			
	MOV	--	--	10D560K	10D101K
	LDM1	--	--	56μH	56μH
	TVS	SMCJ13A	SMCJ28A	SMCJ48A	SMCJ100A
	C0	680μF/16V	680μF/25V	120μF/50V	120μF/100V
EMI	C0	680μF/16V	--	--	--
	LDM2	4.7μH (MSB05_MD-3W)	--	--	--
	C1	--	4.7μF/50V	4.7μF/50V	4.7μF/100V
	C2	--	100pF/2KV (MSB12_D-3W) 1000pF/2KV (MSB12_MD-3W)	1000pF/2KV (MSB24_MD-3W)	100pF/2KV (MSB48_MD-3W)
	C3	--	100pF/2KV	100pF/2KV	100pF/2KV

Note: 1. In Figure 1, part ① is EMS Recommended external circuit, part ② is EMI recommended external circuit. Choose according to requirements.
2. If there is no recommended parameters, the model no require the external component.

EMC RECOMMENDED CIRCUIT PCB LAYOUT

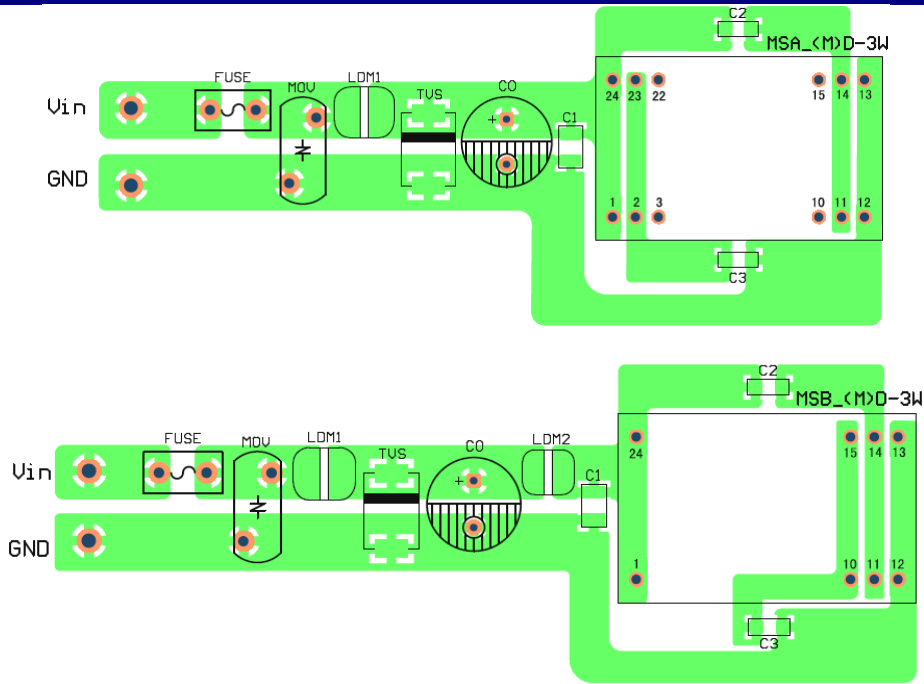

(Figure 2)

PRODUCT TYPICAL CURVE

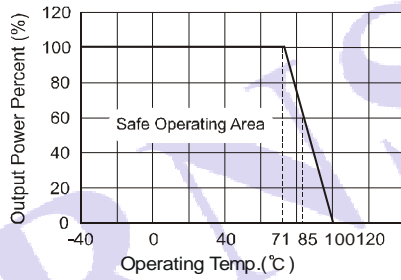

Efficiency VS Output Load curve (Full Load)

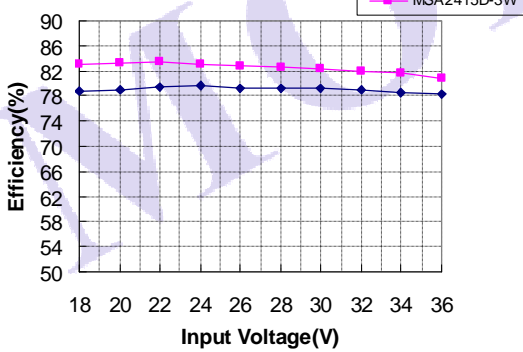

Efficiency VS Output Load curve (Vin=Vin-nominal)

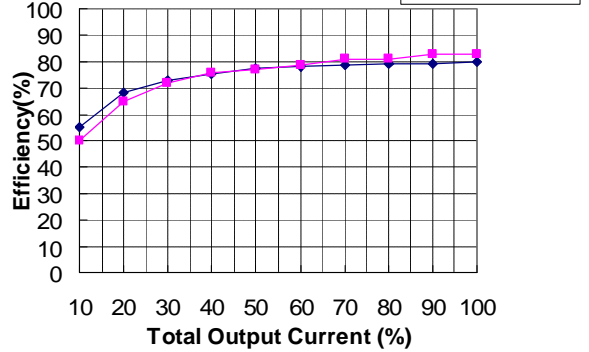

Efficiency VS Output Load curve (Full Load)

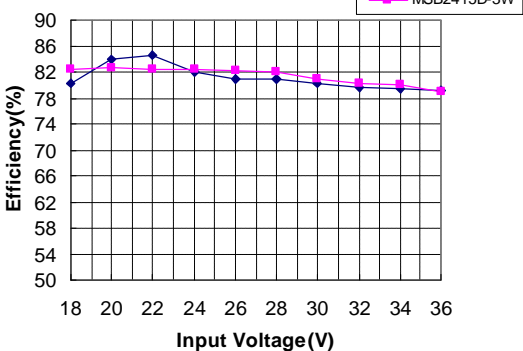

Efficiency VS Output Load curve (Vin=Vin-nominal)

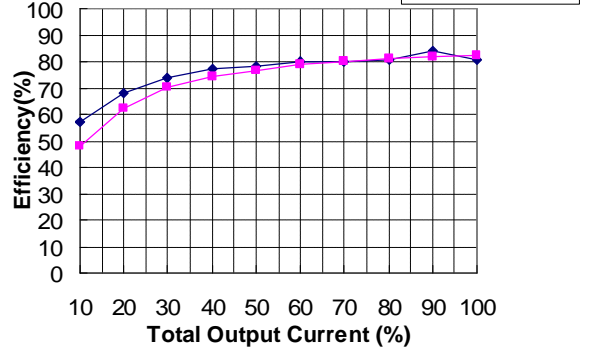

OUTLINE DIMENSIONS, RECOMMENDED FOOTPRINT & PACKAGING

MECHANICAL DIMENSIONS

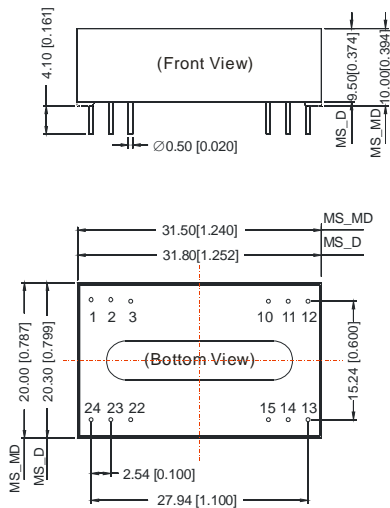

FOOTPRINT DETAILS		
Pin	Single	Dual
1,24	Vin	Vin
2,23	No Pin	-Vo
3,22	No Pin	0V
10,15	0V	0V
11,14	+Vo	+Vo
12,13	GND	GND

NC: No connection

Note:
Unit: mm[inch]
Pin diameter tolerances: $\pm 0.10\text{mm} [\pm 0.004\text{inch}]$
General tolerances: $\pm 0.25\text{mm} [\pm 0.010\text{inch}]$

RECOMMENDED FOOTPRINT

DUAL OUTPUT

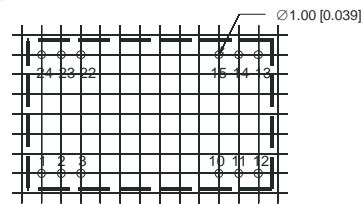

SINGLE OUTPUT



Note: grid 2.54*2.54mm.

TUBE OUTLINE DIMENSIONS

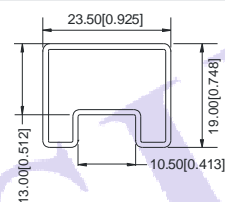

Note:
Unit: mm[inch]
General tolerances: $\pm 0.50\text{mm} [\pm 0.020\text{inch}]$
L=530mm[20.866inch] Tube Quantity: 15pcs
L=220mm[8.661inch] Tube Quantity: 6pcs
Short tube inner package dimensions: L*W*H= 255*170*80mm
Short tube outer package dimensions(with six inner package boxes):
L*W*H= 375*280*270mm
Long tube inner package dimensions: L*W*H= 580*200*100mm
Long tube outer package dimensions(with two inner package boxes):
L*W*H= 600*215*220mm
Long tube outer package dimensions(with three inner package boxes):
L*W*H= 600*215*325mm

TEST CONFIGURATIONS

Input Reflected-Ripple Current Test Setup

Input reflected-ripple current is measured with an inductor L_{in} and Capacitor C_{in} to simulate source impedance.

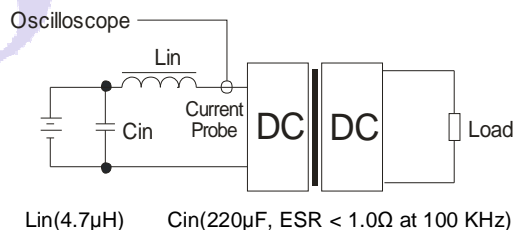

DESIGN CONSIDERATIONS

1) Requirement on output load

To ensure this module can operate efficiently and reliably, During operation, the minimum output load **could not be less than 10% of the full load**. If the actual output power is very small, please connect a resistor with proper resistance at the output end in parallel to increase the load, or use our company's products with a lower rated output power.

2) Overload Protection

Under normal operating conditions, the output circuit of these products has no protection against overload. The simplest method is add a circuit breaker to the circuit.

3) Recommended circuit

All the MSA_(M)D-3W & MSB_(M)D-3W Series have been tested according to the following recommended testing circuit before leaving factory(Figure 3).

If you want to further decrease the input/output ripple, you can increase a capacitance properly or choose capacitors with low ESR. However, the capacitance of the output filter capacitor must be proper. If the capacitance is too big, a startup problem might arise. For every channel of output, provided the safe and reliable operation is ensured, the greatest capacitance of its filter capacitor must less than the Max. Capacitive Load. Generally: If you want to use the products in high EMI, please choose our metal packaged products (MSA_MD-3W & MSB_MD- 3W).

General: Cin: 5V&12V 100 μ F
24V&48V 10 μ F-47 μ F
Cout: 10 μ F/100mA

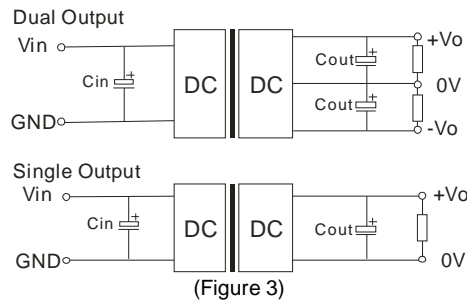

4) Input current

Nominal input voltage range. The input current of the power supply must be sufficient to the startup current (I_p) of the DC/DC module (Figure 4).
 General: $I_p \leq 1.4 \cdot I_{in-max}$

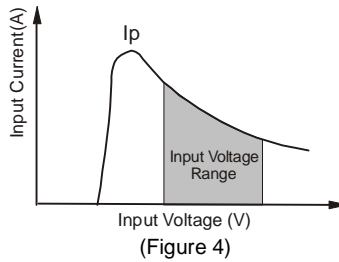

5) Cannot use in parallel and hot swap

Note:

1. Operation under minimum load will not damage the converter; However, they may not meet all specification listed.
2. Max. Capacitive Load tested at input voltage range and full load.
3. All specifications measured at $T_a=25^\circ\text{C}$, humidity < 75%, nominal input voltage and rated output load unless otherwise specified.
4. In this datasheet, all the test methods of indications are based on our corporate standards.
5. All characteristics are for listed model only, non-standard models may perform differently, please contact our technical person for more detail.
6. Contact us for your specific requirement.
7. Specifications subject to change without prior notice.

MORNSUN Science & Technology Co.,Ltd.

Address: No. 5, Kehui St. 1, Kehui development center, Science Ave., Guangzhou Science City, Luogang district, Guangzhou, P.R.China.

Tel: 86-20-38601850

Fax: 86-20-38601272

[Http://www.mornsun-power.com](http://www.mornsun-power.com)