



# MURF1605CT THRU MURF1660CT

## SUPER FAST RECOVERY SILICON RECTIFIER

Reverse Voltage - 50 to 600 Volts      Forward Current - 16.0 Ampere

### FEATURES

- The plastic package carries Underwriters Laboratory Flammability Classification 94V-0
- Super fast switching for high efficiency
- Low reverse leakage
- High forward surge current capability
- High temperature soldering guaranteed:  
250°C/10 seconds, 0.25" (6.35mm) from case

### MECHANICAL DATA

- Case: JEDEC ITO-220AB molded plastic body
- Terminals: Plated leads, solderable per MIL-STD-750, Method 2026
- High temperature soldering guaranteed:  
250°C/10 seconds, 0.25" (6.35mm) from case
- Polarity: As marked
- Mounting Position: Any
- Mounting Torque: 10 in-lbs maximum
- Weight: 0.08 ounce, 2.24 grams

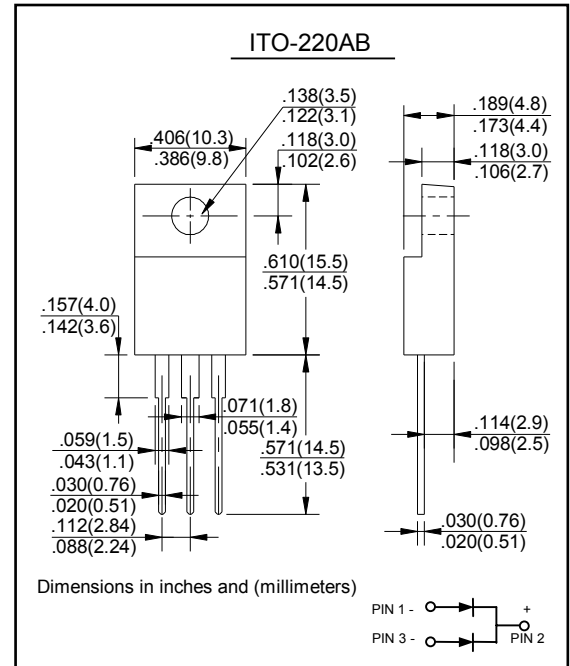

### MAXIMUM RATINGS AND ELECTRICAL CHARACTERISTICS

Ratings at 25°C ambient temperature unless otherwise specified.  
Single phase half-wave 60Hz, resistive or inductive load, for capacitive load current derate by 20%.

Characteristic	Symbol	MURF 1605CT	MURF 1610CT	MURF 1615CT	MURF 1620CT	MURF 1630CT	MURF 1640CT	MURF 1660CT	Unit	
Peak Repetitive Reverse Voltage	$V_{RRM}$									
Working Peak Reverse Voltage	$V_{RWM}$	50	100	150	200	300	400	600	V	
DC Blocking Voltage	$V_R$									
RMS Reverse Voltage	$V_{R(RMS)}$	35	70	105	140	210	280	420	V	
Average Rectified Output Current @ $T_C = 105^\circ\text{C}$	$I_O$	16							A	
Non-Repetitive Peak Forward Surge Current 8.3ms Single half sine-wave superimposed on rated load (JEDEC Method)	$I_{FSM}$	125							A	
Forward Voltage @ $I_F = 8.0\text{A}$	$V_{FM}$	0.95			1.3		1.7		V	
Peak Reverse Current @ $T_A = 25^\circ\text{C}$ At Rated DC Blocking Voltage @ $T_A = 125^\circ\text{C}$	$I_{RM}$	10 500							$\mu\text{A}$	
Reverse Recovery Time (Note 1)	$t_{rr}$	35				50			nS	
Typical Junction Capacitance (Note 2)	$C_j$	80				60			pF	
Operating and Storage Temperature Range	$T_J, T_{STG}$	-65 to +150								$^\circ\text{C}$

Note: 1. Measured with  $I_F = 0.5\text{A}$ ,  $I_R = 1.0\text{A}$ ,  $IRR = 0.25\text{A}$ .  
2. Measured at 1.0 MHz and applied reverse voltage of 4.0V D.C.



# MURF1605CT THRU MURF1660CT

## RATINGS AND CHARACTERISTIC CURVES

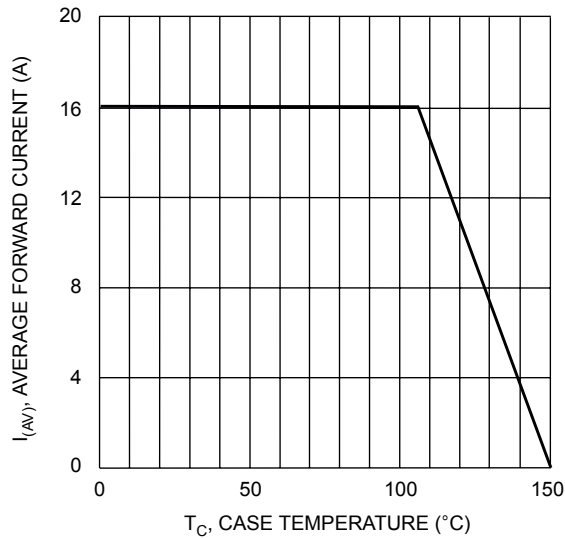

Fig. 1 Forward Current Derating Curve

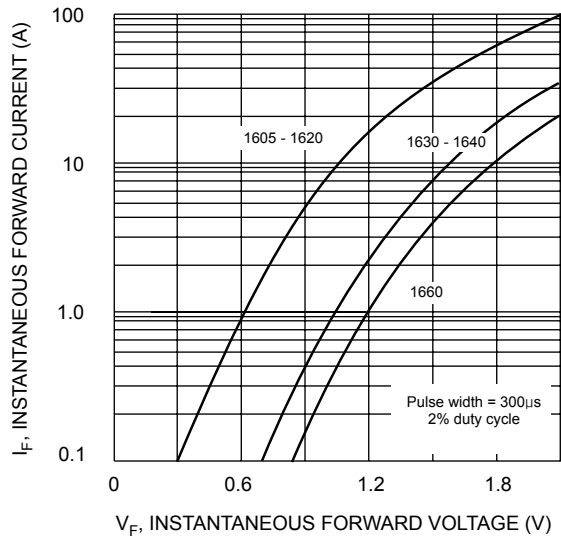

Fig. 2 Typical Forward Characteristics

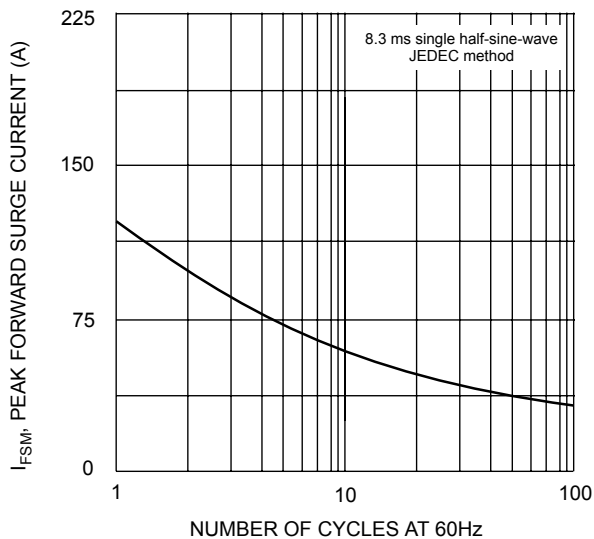

Fig. 3 Maximum Non-Repetitive Surge Current

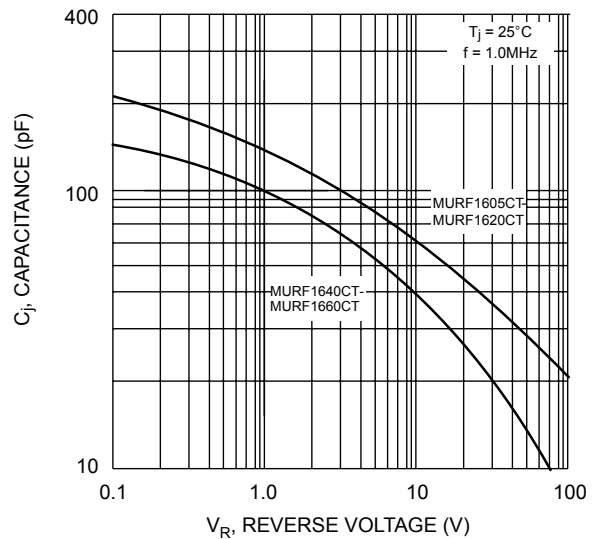
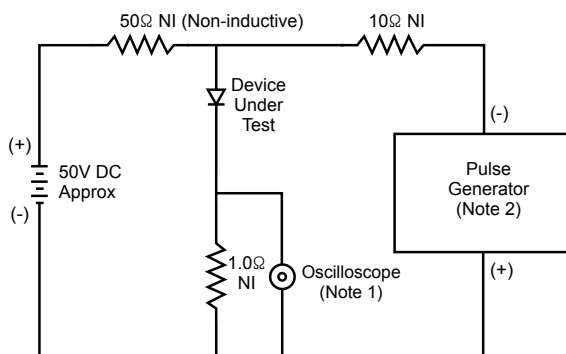
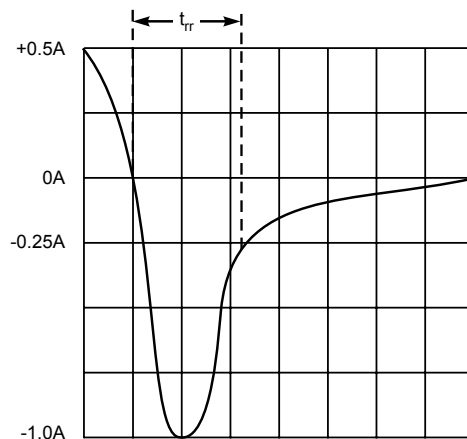

Fig. 4 Typical Junction Capacitance



- Notes:
1. Rise Time = 7.0ns max. Input Impedance = 1.0MΩ, 22pF.
  2. Rise Time = 10ns max. Input Impedance = 50Ω.



Set time base for 5/10ns/cm

Fig. 5 Reverse Recovery Time Characteristic and Test Circuit