

# Model Name: T315HW07 V1

Issue Date : 2010/05/31

- ( ) Preliminary Specifications  
(\* ) Final Specifications

Customer Signature	Date	AUO	Date
Approved By  _____		Approval By PM Director YenTing Chiu  YenTing Chiu	2010/6/2
Note		Reviewed By RD Director Eugene CC Chen  Eugene Chen	2010/6/2
		Reviewed By Project Leader Sarah Ke  Sarah Ke	2010/6/1
		Prepared By PM Joanne Hsu  Joanne Hsu	

## Contents

No		
		CONTENTS
		RECORD OF REVISIONS
1		GENERAL DESCRIPTION
2		ABSOLUTE MAXIMUM RATINGS
3		ELECTRICAL SPECIFICATION
	3-1	ELECTRICAL CHARACTERISTICS
	3-2	INTERFACE CONNECTIONS
	3-3	SIGNAL TIMING SPECIFICATION
	3-4	SIGNAL TIMING WAVEFORM
	3-5	COLOR INPUT DATA REFERENCE
	3-6	POWER SEQUENCE
	3-7	BACKLIGHT SPECIFICATION
4		OPTICAL SPECIFICATION
5		MECHANICAL CHARACTERISTICS
6		RELIABILITY TEST ITEMS
7		INTERNATIONAL STANDARD
	7-1	SAFETY
	7-2	EMC
8		PACKING
	8-1	DEFINITION OF LABEL
	8-2	PACKING METHODS
	8-3	PALLET AND SHIPMENT INFORMATION
9		PRECAUTION
	9-1	MOUNTING PRECAUTIONS
	9-2	OPERATING PRECAUTIONS
	9-3	ELECTROSTATIC DISCHARGE CONTROL
	9-4	PRECAUTIONS FOR STRONG LIGHT EXPOSURE
	9-5	STORAGE
	9-6	HANDLING PRECAUTIONS FOR PROTECT FILM



# 1. General Description

This specification applies to the 31.5 inch Color TFT-LCD Module T315HW07 V1. This LCD module has a TFT active matrix type liquid crystal panel 1,920x1,080 pixels, and diagonal size of 31.5 inch. This module supports 1,920x1080 mode. Each pixel is divided into Red, Green and Blue sub-pixels or dots which are arranged in vertical stripes. Gray scale or the brightness of the sub-pixel color is determined with a 10-bit gray scale signal for each dot.

The T315HW07 V1 has been designed to apply the 10-bit 2 channel LVDS interface method. It is intended to support displays where high brightness, wide viewing angle, high color saturation, and high color depth are very important.

## \* General Information

Items	Specification	Unit	Note
Active Screen Size	31.55	inch	
Display Area	698.40(H) x 392.85(V)	mm	
Outline Dimension	739.6(H) x 440.0 (V) x 24.1(D)	mm	D : Front bezel to T-CON cover
Driver Element	a-Si TFT active matrix		
Display Colors	10 bit(8+FRC), 1073.7M	Colors	
Number of Pixels	1,920x1080	Pixel	
Pixel Pitch	0.3638 (H) x 0.3638 (W)	mm	
Pixel Arrangement	RGB vertical stripe		
Display Operation Mode	Normally Black		
Surface Treatment	Anti-Glare, 3H		Haze=11%

## 2. Absolute Maximum Ratings

The followings are maximum values which, if exceeded, may cause faulty operation or damage to the unit

Item	Symbol	Min	Max	Unit	Conditions
Logic/LCD Drive Voltage	Vcc	-0.3	14	[Volt]	Note 1
Input Voltage of Signal	Vin	-0.3	4	[Volt]	Note 1
Operating Temperature	TOP	0	+50	[°C]	Note 2
Operating Humidity	HOP	10	90	[%RH]	Note 2
Storage Temperature	TST	-20	+60	[°C]	Note 2
Storage Humidity	HST	10	90	[%RH]	Note 2
Panel Surface Temperature	PST		65	[°C]	Note 3

Note 1: Duration:50 msec.

Note 2 : Maximum Wet-Bulb should be 39°C and No condensation.

The relative humidity must not exceed 90% non-condensing at temperatures of 40°C or less. At temperatures greater than 40°C, the wet bulb temperature must not exceed 39°C.

Note 3: Surface temperature is measured at 50°C Dry condition

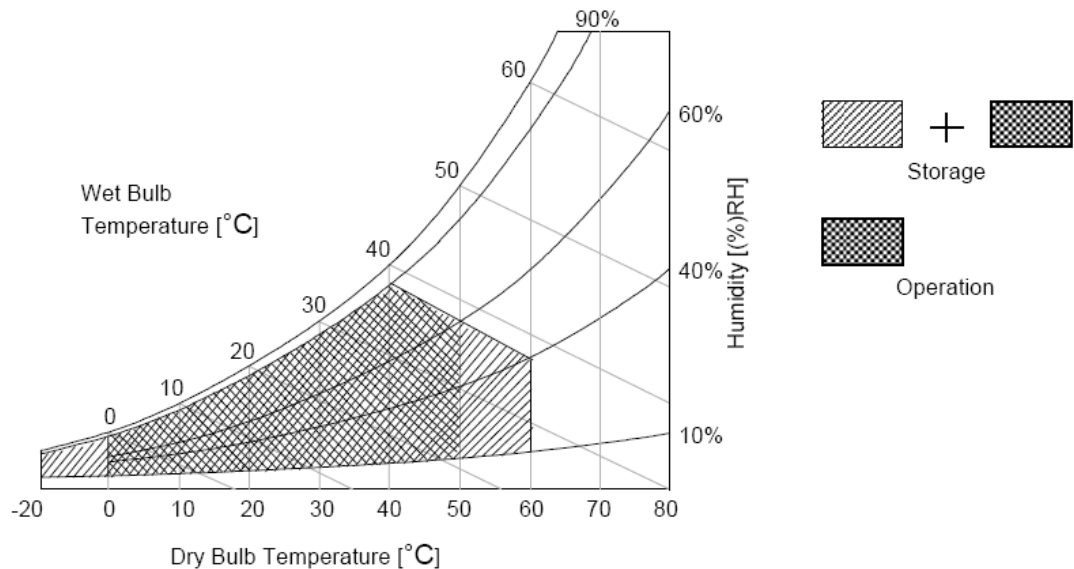

### 3. Electrical Specification

The T315HW07 V1 requires two power inputs. One is employed to power the LCD electronics and to drive the TFT array and liquid crystal. The second is employed for LED lightbar.

#### 3.1 Electrical Characteristics

Parameter		Symbol	Value			Unit	Note
			Min.	Typ.	Max		
LCD							
Power Supply Input Voltage		$V_{DD}$	10.8	12	13.2	$V_{DC}$	1
Power Supply Input Current		$I_{DD}$	-	1.1	1.42	A	2
Power Consumption		$P_C$		13.2	17.0	Watt	2
Inrush Current		$I_{RUSH}$			3	A	3
LVDS Interface	Differential Input High Threshold Voltage	$V_{TH}$	--	--	+100	$mV_{DC}$	4
	Differential Input Low Threshold Voltage	$V_{TL}$	-100	--	--	$mV_{DC}$	4
	Input Common Mode Voltage	$V_{ICM}$	1.1	1.25	1.4	$V_{DC}$	4
LVDS Interface	Input Channel Pair Skew Margin	$t_{SKEW (CP)}$	-500	--	+500	ps	5
CMOS Interface	Input High Threshold Voltage	$V_{IH}$ (High)	2.7	--	3.3	$V_{DC}$	
	Input Low Threshold Voltage	$V_{IL}$ (Low)	0	--	0.6	$V_{DC}$	
Life Time (MTTF)			<b>30000</b>		--	Hours	6,7

**Note :**

1. The ripple voltage should be controlled under 10% of  $V_{CC}$
2. Test Condition:
  - (1)  $V_{DD} = 12.0V$
  - (2) Fv = Type Timing, 60Hz, 120Hz or Other
  - (3)  $F_{CLK} = \text{Max freq.}$
  - (4) Temperature = 25 °C
  - (5) Test Pattern : White Pattern

3. Measurement condition : Rising time = 400us

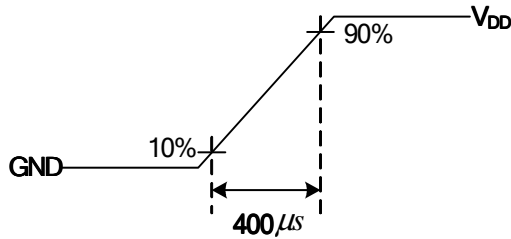

4.  $V_{ICM} = 1.25V$

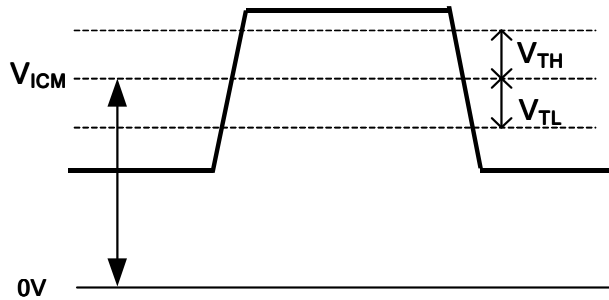

5. Input Channel Pair Skew Margin

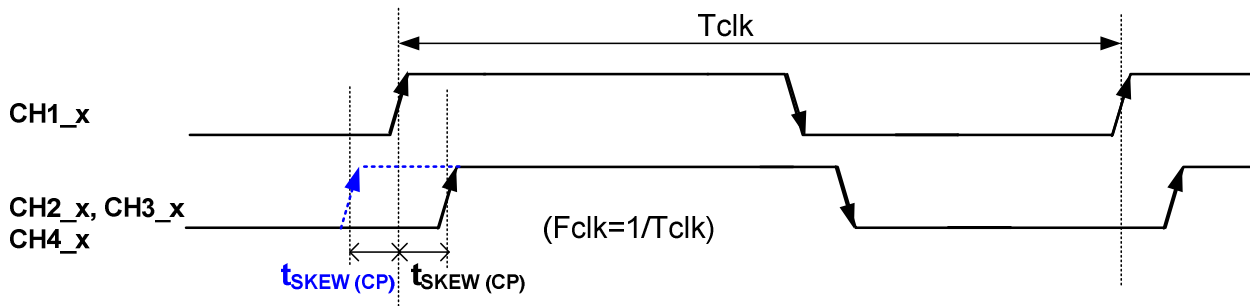

- The relative humidity must not exceed 80% non-condensing at temperatures of 40°C or less. At temperatures greater than 40°C, the wet bulb temperature must not exceed 39°C. When operate at low temperatures, the brightness of LED will drop and the life time of LED will be reduced.
- The lifetime (MTTF) is defined as the time which luminance of LED is 50% compared to its original value. [Operating condition: Continuous operating at  $T_a = 25 \pm 2^\circ C$ ]

### 3.2 Interface Connections

- LCD connector: FI-RE51S-HF (JAE, LVDS connector)

PIN	Symbol	Description	PIN	Symbol	Description
1	V <sub>DD</sub>	Power Supply, +12V DC Regulated	26	CH2_0+	LVDS Channel 2, Signal 0+
2	V <sub>DD</sub>	Power Supply, +12V DC Regulated	27	CH2_1-	LVDS Channel 2, Signal 1-
3	V <sub>DD</sub>	Power Supply, +12V DC Regulated	28	CH2_1+	LVDS Channel 2, Signal 1+
4	V <sub>DD</sub>	Power Supply, +12V DC Regulated	29	CH2_2-	LVDS Channel 2, Signal 2-
5	V <sub>DD</sub>	Power Supply, +12V DC Regulated	30	CH2_2+	LVDS Channel 2, Signal 2+
6	Reserved	AUO Internal Use Only	31	GND	Ground
7	GND	Ground	32	CH2_CLK-	LVDS Channel 2, Clock -
8	GND	Ground	33	CH2_CLK+	LVDS Channel 2, Clock +
9	GND	Ground	34	GND	Ground
10	CH1_0-	LVDS Channel 1, Signal 0-	35	CH2_3-	LVDS Channel 2, Signal 3-
11	CH1_0+	LVDS Channel 1, Signal 0+	36	CH2_3+	LVDS Channel 2, Signal 3+
12	CH1_1-	LVDS Channel 1, Signal 1-	37	Reserved	AUO Internal Use Only
13	CH1_1+	LVDS Channel 1, Signal 1+	38	Reserved	AUO Internal Use Only
14	CH1_2-	LVDS Channel 1, Signal 2-	39	GND	Ground
15	CH1_2+	LVDS Channel 1, Signal 2+	40	SCL	EEPROM Serial Clock
16	GND	Ground	41	SDA	EEPROM Serial Data
17	CH1_CLK-	LVDS Channel 1, Clock -	42	VSYNC	VSYNC output to system board
18	CH1_CLK+	LVDS Channel 1, Clock +	43	BUS_SW	BUS_SW (SONY internal use only)
19	GND	Ground	44	Panel_SEL	Panel_SEL (SONY internal use only)
20	CH1_3-	LVDS Channel 1, Signal 3-	45	SET_ON2	SET_ON2 (SONY internal use only)
21	CH1_3+	LVDS Channel 1, Signal 3+	46	SA_MODE	SA_MODE (SONY internal use only)
22	Reserved	AUO Internal Use Only	47	Panel_ON	Panel_ON (10kohm to GND)
23	Reserved	AUO Internal Use Only	48	FRC_RST	FRC_RST (SONY internal use only)
24	GND	Ground	49	HSYNC	HSYNC output to system board
25	CH2_0-	LVDS Channel 2, Signal 0-	50	TCON_RDY	Send TCON Ready to system
			51	FR_SEL	10kohm to GND



**LVDS Option = High/Open→NS**

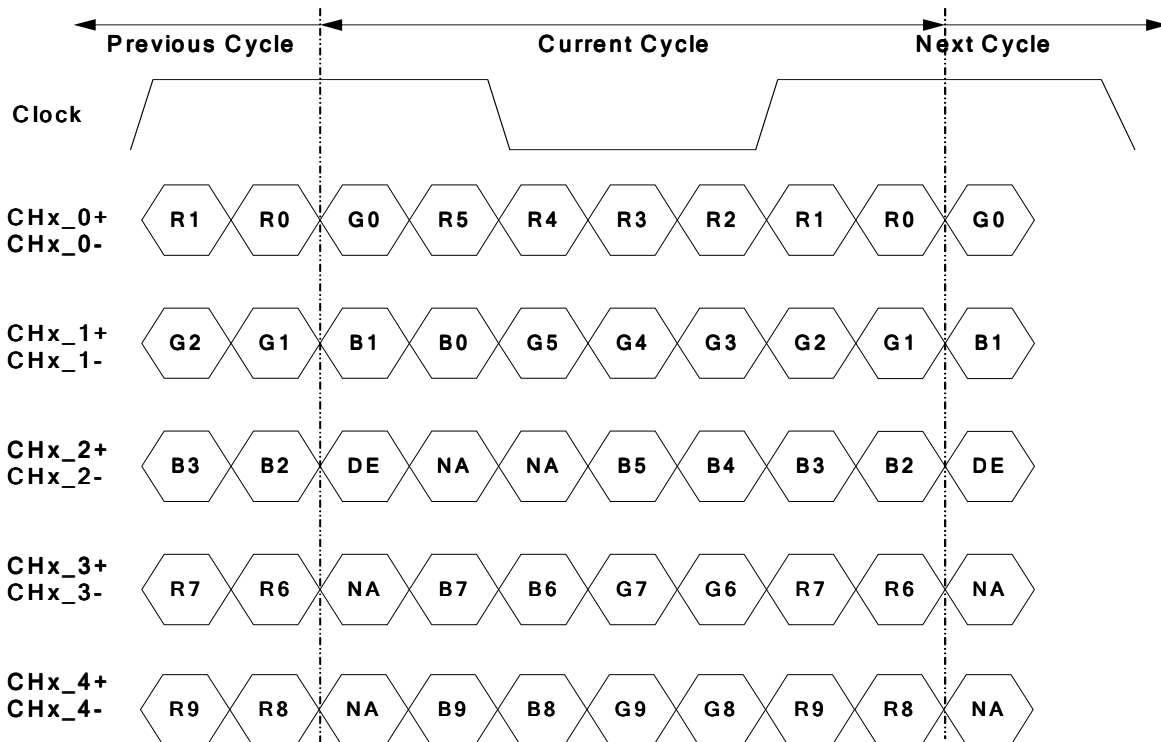

Note: x = 1, 2, 3, 4...

**LVDS Option = Low→JEIDA**

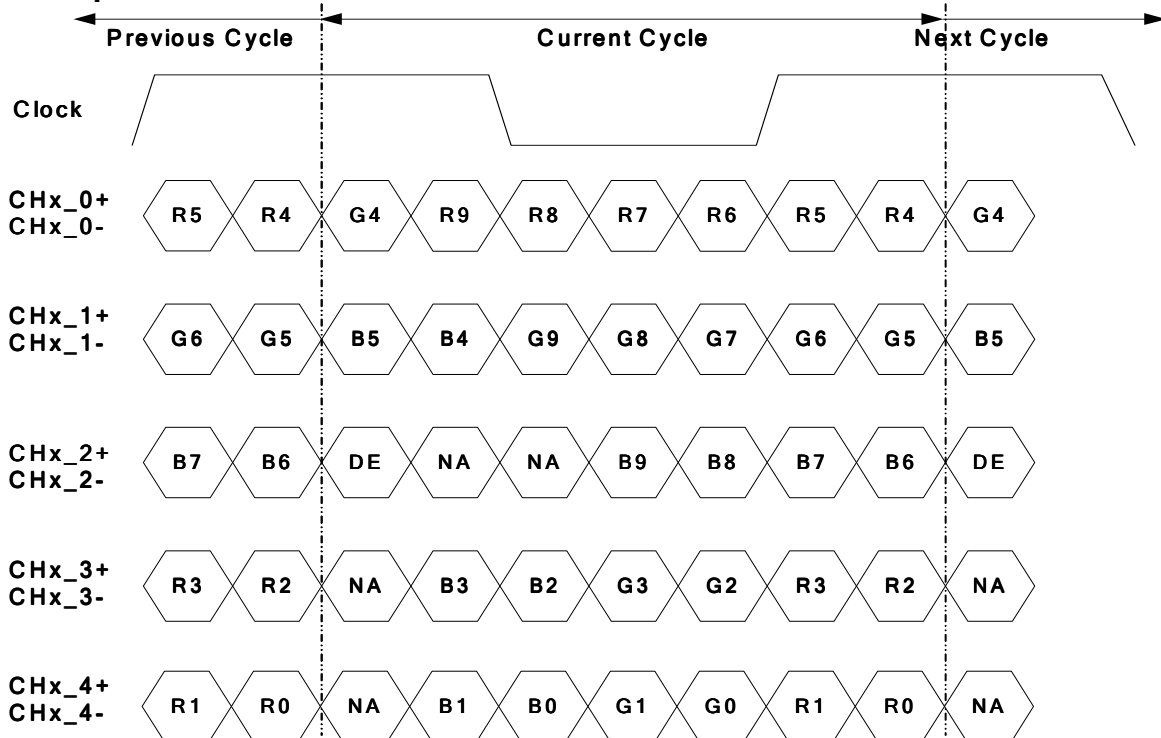

Note: x = 1, 2, 3, 4...

### 3.3 Signal Timing Specification

This is the signal timing required at the input of the user connector. All of the interface signal timing should be satisfied with the following specifications for its proper operation.

**Timing Table**

Signal	Item	Symbol	Min.	Typ.	Max	Unit
Vertical Section	Period	Tv	-	1134	-	Th
	Active	Tdisp (v)	1080			Th
	Blanking	Tblk (v)	-	54	-	Th
	Front porch	Tfp (v)	-	34	-	Th
	Back porch	Tbp (v)	-	16	-	Th
	V_sync	TVsync_wdth	-	4	-	Th
	Polarity	POL (v)	+			
Horizontal Section	Period	Th	-	1092	-	Tclk
	Active	Tdisp (h)	960			Tclk
	Blanking	Tblk (h)	-	132	-	Tclk
	Front porch	Tfp (h)	-	16	-	Tclk
	Back porch	Tbp (h)	-	100	-	Tclk
	H_sync	THsync_wdth	-	16	-	Tclk
	Polarity	POL (h)	+			
Clock	Frequency	Fclk=1/Tclk	-	74.23	-	MHz
Vertical Frequency	Frequency	Fv	-	59.94	-	Hz
Horizontal Frequency	Frequency	Fh	-	67.97	-	KHz

Notes:

(1) Display position is specific by the rise of DE signal only.

Horizontal display position is specified by the rising edge of 1<sup>st</sup> DCLK after the rise of 1<sup>st</sup> DE, is displayed on the left edge of the screen.

(2) Vertical display position is specified by the rise of DE after a “Low” level period equivalent to eight times of horizontal period. The 1<sup>st</sup> data corresponding to one horizontal line after the rise of 1<sup>st</sup> DE is displayed at the top line of screen.

(3) If a period of DE “High” is less than 1920 DCLK or less than 1080 lines, the rest of the screen displays black.

(4) The display position does not fit to the screen if a period of DE “High” and the effective data period do not synchronize with each other.

### 3.4 Signal Timing Waveforms

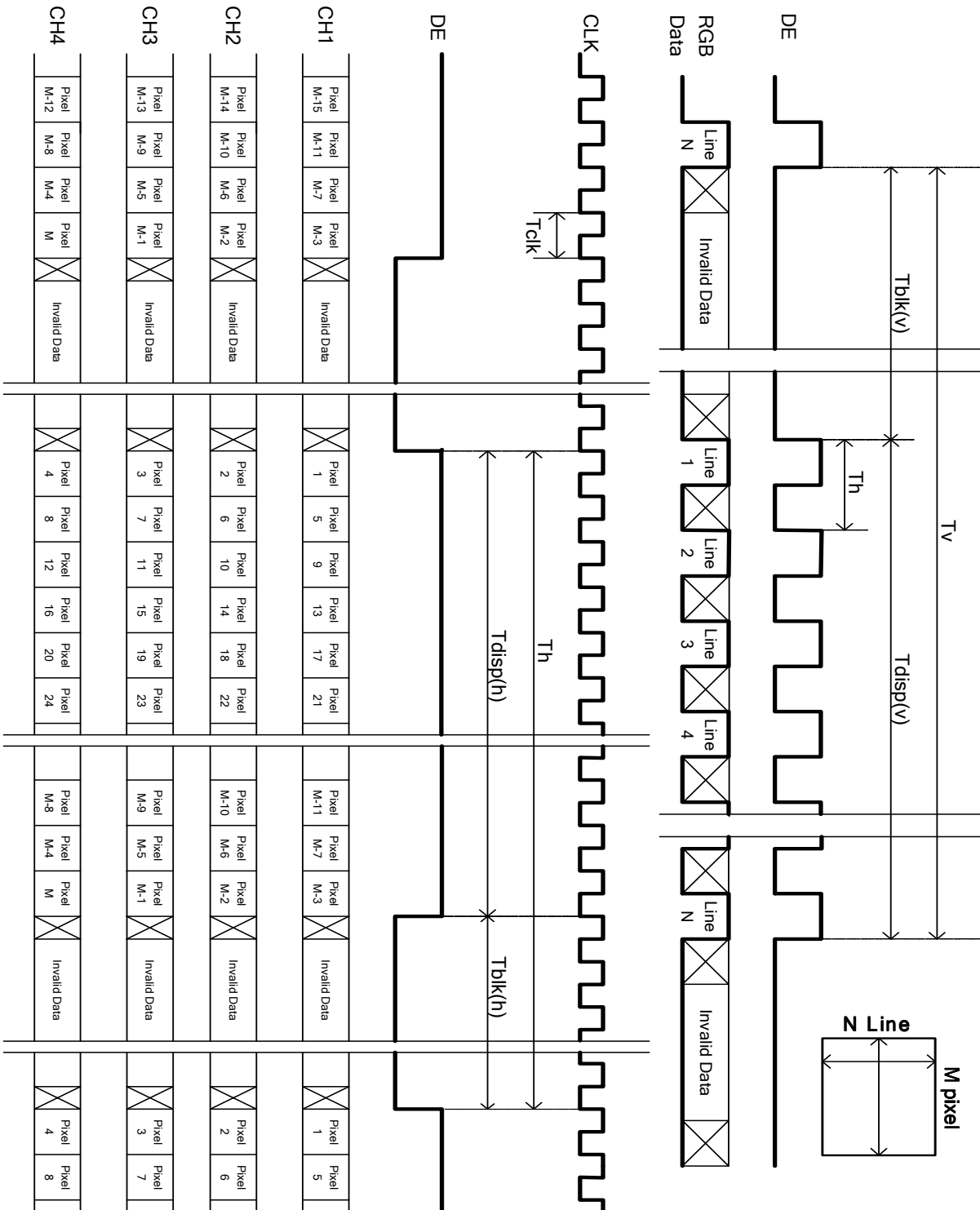

### 3.5 Color Input Data Reference

The brightness of each primary color (red, green and blue) is based on the 10 bit gray scale data input for the color; the higher the binary input, the brighter the color. The table below provides a reference for color versus data input.

**COLOR DATA REFERENCE**

Color		Input Color Data																													
		RED										GREEN										BLUE									
		MSB					LSB					MSB					LSB					MSB					LSB				
		R9	R8	R7	R6	R5	R4	R3	R2	R1	R0	G9	G8	G7	G6	G5	G4	G3	G2	G1	G0	B9	B8	B7	B6	B5	B4	B3	B2	B1	B0
Basic Color	Black	0	0	0	0	0	0	0	0	0	0	0	0	0	0	0	0	0	0	0	0	0	0	0	0	0	0	0	0	0	0
	Red(1023)	1	1	1	1	1	1	1	1	1	1	0	0	0	0	0	0	0	0	0	0	0	0	0	0	0	0	0	0	0	0
	Green(1023)	0	0	0	0	0	0	0	0	0	0	1	1	1	1	1	1	1	1	1	1	0	0	0	0	0	0	0	0	0	0
	Blue(1023)	0	0	0	0	0	0	0	0	0	0	0	0	0	0	0	0	0	0	0	0	1	1	1	1	1	1	1	1	1	1
	Cyan	0	0	0	0	0	0	0	0	0	0	1	1	1	1	1	1	1	1	1	1	1	1	1	1	1	1	1	1	1	1
	Magenta	1	1	1	1	1	1	1	1	1	1	0	0	0	0	0	0	0	0	0	0	1	1	1	1	1	1	1	1	1	1
	Yellow	1	1	1	1	1	1	1	1	1	1	1	1	1	1	1	1	1	1	1	1	0	0	0	0	0	0	0	0	0	0
	White	1	1	1	1	1	1	1	1	1	1	1	1	1	1	1	1	1	1	1	1	1	1	1	1	1	1	1	1	1	1
R	RED(000)	0	0	0	0	0	0	0	0	0	0	0	0	0	0	0	0	0	0	0	0	0	0	0	0	0	0	0	0	0	
	RED(001)	0	0	0	0	0	0	0	0	1	0	0	0	0	0	0	0	0	0	0	0	0	0	0	0	0	0	0	0	0	
	----																														
	RED(1022)	1	1	1	1	1	1	1	1	0	0	0	0	0	0	0	0	0	0	0	0	0	0	0	0	0	0	0	0	0	
	RED(1023)	1	1	1	1	1	1	1	1	1	0	0	0	0	0	0	0	0	0	0	0	0	0	0	0	0	0	0	0	0	
G	GREEN(000)	0	0	0	0	0	0	0	0	0	0	0	0	0	0	0	0	0	0	0	0	0	0	0	0	0	0	0	0	0	
	GREEN(001)	0	0	0	0	0	0	0	0	0	0	0	0	0	0	0	0	0	0	1	0	0	0	0	0	0	0	0	0	0	
	----																														
	GREEN(1022)	0	0	0	0	0	0	0	0	0	1	1	1	1	1	1	1	1	1	0	0	0	0	0	0	0	0	0	0	0	
	GREEN(1023)	0	0	0	0	0	0	0	0	0	1	1	1	1	1	1	1	1	1	1	0	0	0	0	0	0	0	0	0	0	
B	BLUE(000)	0	0	0	0	0	0	0	0	0	0	0	0	0	0	0	0	0	0	0	0	0	0	0	0	0	0	0	0	0	
	BLUE(001)	0	0	0	0	0	0	0	0	0	0	0	0	0	0	0	0	0	0	0	0	0	0	0	0	0	0	0	0	1	
	----																														
	BLUE(1022)	0	0	0	0	0	0	0	0	0	0	0	0	0	0	0	0	0	0	0	1	1	1	1	1	1	1	1	1	0	
	BLUE(1023)	0	0	0	0	0	0	0	0	0	0	0	0	0	0	0	0	0	0	0	1	1	1	1	1	1	1	1	1	1	

### 3.6 Power Sequence for LCD

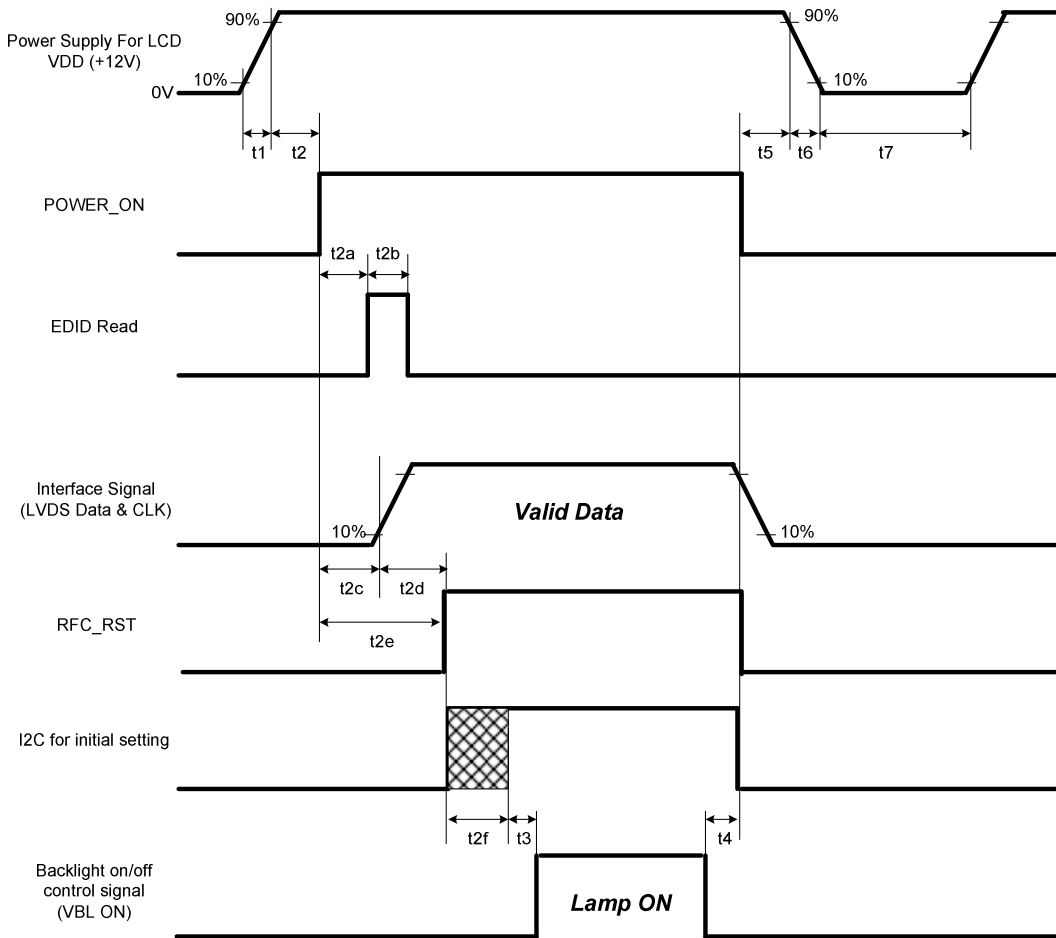

Parameter	Standard <sup>*1</sup>			Standalone <sup>*1</sup>	Unit
	Min.	Type.	Max.	Type.	
t1	0.4	---	30	---	ms
t2	10	---	---	57	ms
t2a	10	---	100	---	ms
t2b	0 <sup>*4</sup>	---	100 <sup>*4</sup>	---	ms
t2c	10	---	---	---	ms
t2d	10	---	---	---	ms
t2e	---	---	---	102	ms
t2f	---	---	250	204	ms
t3	500	---	---	---	ms
t4	0 <sup>*2</sup>	---	---	---	ms
t5	0	---	---	---	ms
t6	---	---	---	---	ms
t7	500	---	---	---	ms

Note:

- (1) Standard mode is used for customer's operation. Standalone mode is used for panel factory operation.
- (2) t4=0 : concern for residual pattern before BLU turn off.
- (3) t6 : voltage of VDD must decay smoothly after power-off. (customer system decide this value)
- (4) t2b : customer decides this value

### 3.7 Backlight Specification

The backlight unit contains 2pcs light bar.

#### 3.7.1 Lightbar Driving Condition

Parameter		Symbole	Values			Unit	Note
			Min	Typ	Max		
Forward Current	Anode	IF (anode)		120		mA	
(one lightbar)	Cathode	IF (cathode)	-	120	-	mA	
Forward Voltage		VF	232	264	288	V	
Forward Voltage Variation		ΔVF				V	
Total Power Consumption (2 lightbar)		PBL	27.8	31.7	34.6	W	Note 1&2
PWM Operation Frequency		F_PWM	140	180	240	Hz	
PWM Dimming Duty Ratio		D_PWM	10		100	%	

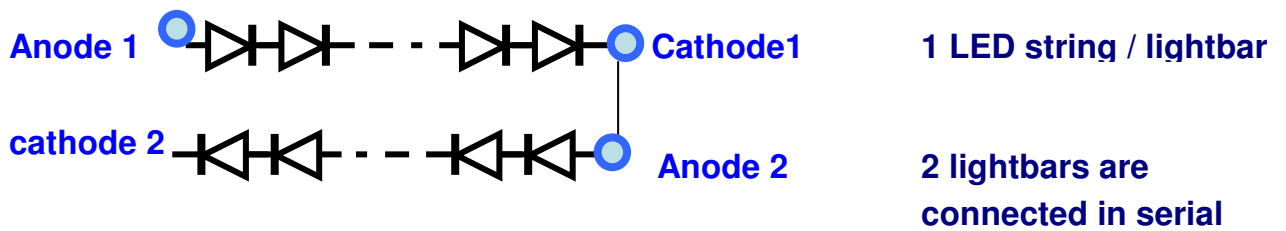

**Note 1:** Dimming range



PWM Dimming : include Internal and External PWM Dimming

**Note 2:** Low dimming ratio operation

When PWM dimming duty ratio is operated lower than recommended value, feedback signal and all protection functions should be confirmed by LIPS design. Display performance should also be confirmed by customer's implement.

### 3.7.2 Input Pin Assignment

**4 Pin CN: molex 51003-0400**

	CN2
	4pin
1	+ IN
2	NC
3	NC
4	NC

**5 Pin CN: molex 51003-0500**

	CN3
	5pin
1	- OUT
2	NC
3	NC
4	NC
5	NC

## 4. Optical Specification

Optical characteristics are determined after the unit has been 'ON' and stable for approximately 45 minutes in a dark environment at 25°C. The values specified are at an approximate distance 50cm from the LCD surface at a viewing angle of  $\phi$  and  $\theta$  equal to 0°.

Fig.1 presents additional information concerning the measurement equipment and method.

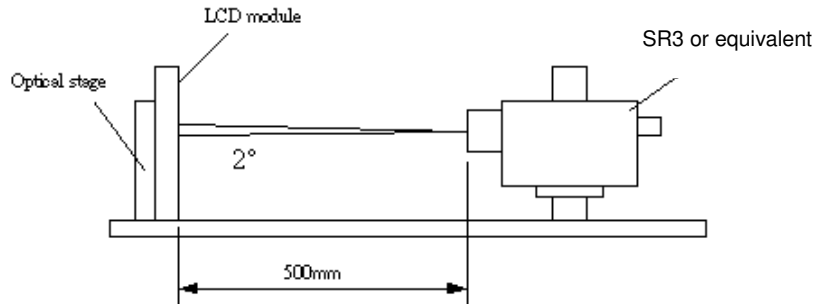

Parameter	Symbol	Values			Unit	Notes
		Min.	Typ.	Max		
Contrast Ratio	CR	3200	4000	--		1
Surface Luminance (White)	$L_{WH}$	320	400	--	cd/m <sup>2</sup>	2
Luminance Variation	$\delta_{WHITE(9P)}$	--	--	1.3		3
Response Time (G to G)	$T_{\gamma}$	--	5.5	--	ms	4
Color Gamut	NTSC		72		%	
Color Coordinates						
Red	$R_x$	Typ.-0.03	0.640	Typ.+0.03		
	$R_y$		0.330			
Green	$G_x$		0.320			
	$G_y$		0.620			
Blue	$B_x$		0.150			
	$B_y$		0.050			
White	$W_x$		0.280			
	$W_y$		0.290			
Viewing Angle						
x axis, right( $\phi=0^\circ$ )	$\theta_r$	--	89	--	degree	5
x axis, left( $\phi=180^\circ$ )	$\theta_l$	--	89	--	degree	
y axis, up( $\phi=90^\circ$ )	$\theta_u$	--	89	--	degree	
y axis, down ( $\phi=270^\circ$ )	$\theta_d$	--	89	--	degree	



Note:

1. Contrast Ratio (CR) is defined mathematically as:

$$\text{Contrast Ratio} = \frac{\text{Surface Luminance of } L_{on5}}{\text{Surface Luminance of } L_{off5}}$$

2. Surface luminance is luminance value at point 5 across the LCD surface 50cm from the surface with all pixels displaying white. From more information see FIG 2. When lamp current  $I_H = 11\text{mA}$ .  $L_{WH} = L_{on5}$  where  $L_{on5}$  is the luminance with all pixels displaying white at center 5 location.

3. The variation in surface luminance,  $\delta_{WHITE}$  is defined (center of Screen) as:

$$\delta_{WHITE(9P)} = \text{Maximum}(L_{on1}, L_{on2}, \dots, L_{on9}) / \text{Minimum}(L_{on1}, L_{on2}, \dots, L_{on9})$$

4. Response time  $T_\gamma$  is the average time required for display transition by switching the input signal for five luminance ratio (0%,25%,50%,75%,100% brightness matrix) and is based on  $F_v=120\text{Hz}$  to optimize.

Measured Response Time		Target				
		0%	25%	50%	75%	100%
Start	0%		0% to 25%	0% to 50%	0% to 75%	0% to 100%
	25%	25% to 0%		25% to 50%	25% to 75%	25% to 100%
	50%	50% to 0%	50% to 25%		50% to 75%	50% to 100%
	75%	75% to 0%	75% to 25%	75% to 50%		75% to 100%
	100%	100% to 0%	100% to 25%	100% to 50%	100% to 75%	

5. Viewing angle is the angle at which the contrast ratio is greater than 10. The angles are determined for the horizontal or x axis and the vertical or y axis with respect to the z axis which is normal to the LCD surface. For more information see FIG3.

**FIG. 2 Luminance**

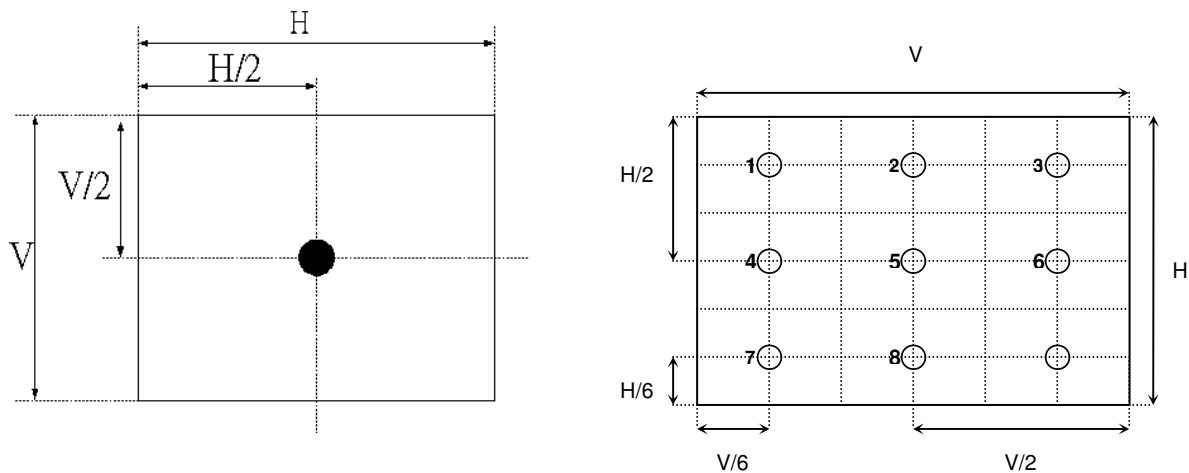

FIG.3 Response Time

The response time is defined as the following figure and shall be measured by switching the input signal for “any level of gray(bright) ” and “any level of gray(dark)”.

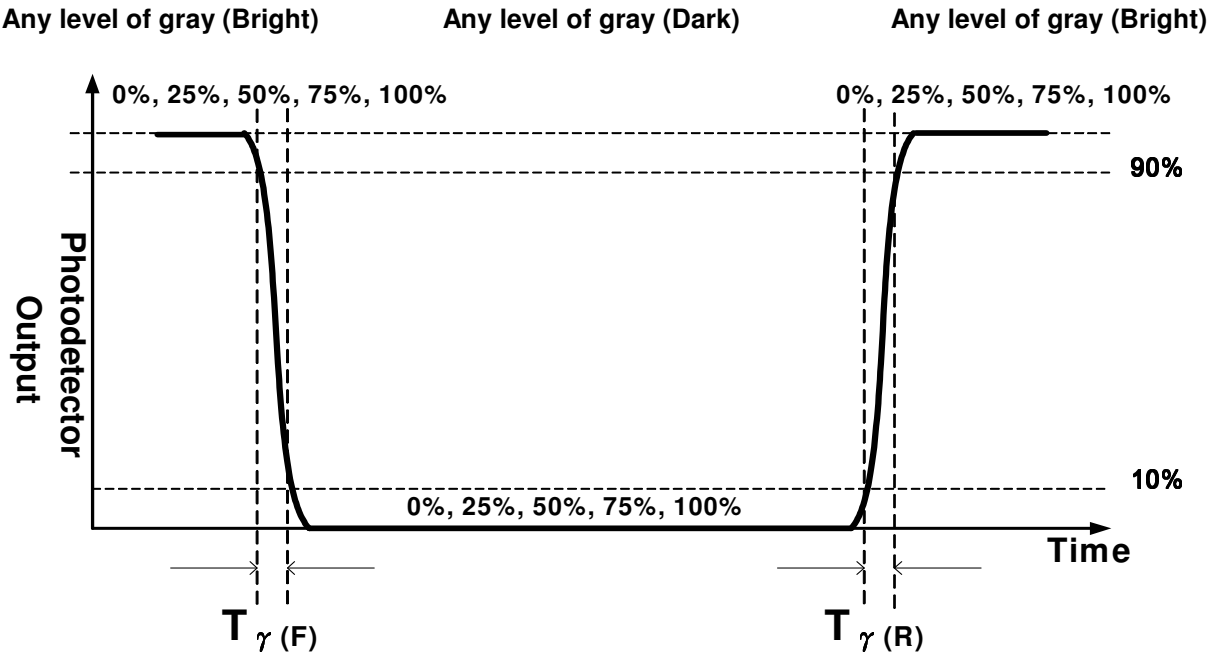
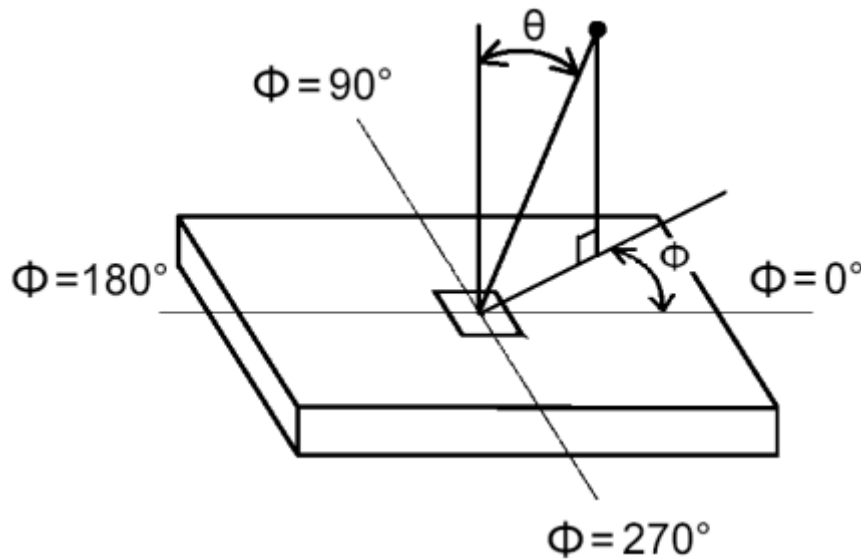

FIG.4 Viewing Angle



## 5. Mechanical Characteristics

The contents provide general mechanical characteristics for the model T315HW07 V1. In addition the figures in the next page are detailed mechanical drawing of the LCD.

Outline Dimension	Horizontal	739.6 mm
	Vertical	440.0 mm
	Depth	24.1 mm ( Front bezel to T-CON cover )
Bezel Opening	Horizontal	703.6 mm
	Vertical	399.80 mm
Active Display Area	Horizontal	698.40 mm
	Vertical	392.85 mm
Weight	4600 g (Typ.)	
Surface Treatment	Anti-Glare, 3H	

**Front View**

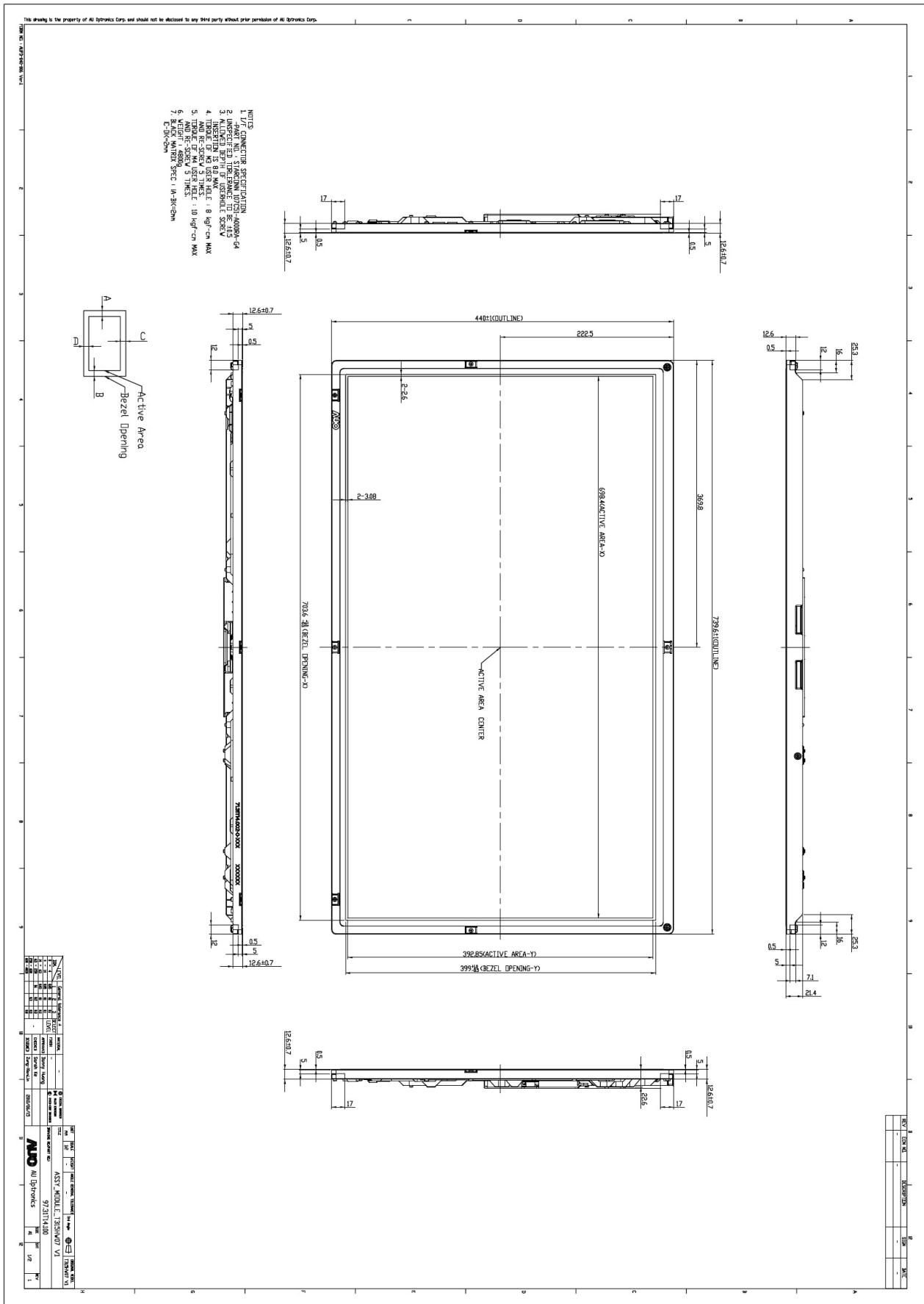



## 6. Reliability Test Items

	Test Item	Q'ty	Condition
1	High temperature storage test	3	60°C, 300hrs
2	Low temperature storage test	3	-20°C, 300hrs
3	High temperature operation test	3	50°C, 300hrs
4	Low temperature operation test	3	-5°C, 300hrs
5	Vibration test (non-operation)	3	Wave form: random Vibration level: 1.0G RMS Bandwidth: 10-300Hz, Duration: X, Y, Z 10min One time each direction
6	Shock test (non-operation)	3	Shock level: 50G Waveform: half sine wave, 11ms Direction: ±X, ±Y, ±Z, One time each direction
7	Vibration test (With carton)	6	Random wave (1.0G RMS, 10-200Hz) 10mins/ Per each X,Y,Z axes
8	Drop test (With carton)	6	Height: 381mm 1 corner, 3 edges, 6 surfaces (ASTMD5276)

## **7. International Standard**

### **7.1 Safety**

- (1) UL 60950-1, UL 60065; Standard for Safety of Information Technology Equipment Including electrical Business Equipment.
- (2) IEC 60950-1 : 2001, IEC 60065:2001 ; Standard for Safety of International Electrotechnical Commission
- (3) EN 60950 : 2001+A11, EN 60065:2002+A1:2006; European Committee for Electrotechnical Standardization (CENELEC), EUROPEAN STANDARD for Safety of Information Technology Equipment Including Electrical Business Equipment.

### **7.2 EMC**

- (1) ANSI C63.4 “Methods of Measurement of Radio-Noise Emissions from Low-Voltage Electrical and Electrical Equipment in the Range of 9kHz to 40GHz. “American National standards Institute(ANSI), 1992
- (2) C.I.S.P.R “Limits and Methods of Measurement of Radio Interface Characteristics of Information Technology Equipment.” International Special committee on Radio Interference.
- (3) EN 55022 “Limits and Methods of Measurement of Radio Interface Characteristics of Information Technology Equipment.” European Committee for Electrotechnical Standardization. (CENELEC), 1998



## 8. Packing

### 8-1 DEFINITION OF LABEL:

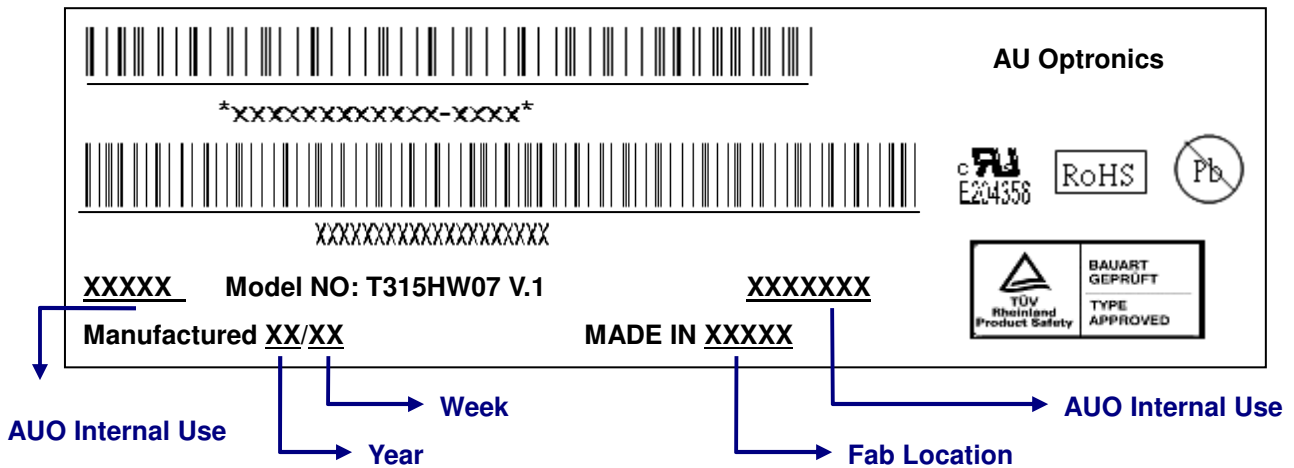
#### A. Panel Label:



#### Green mark description

- (1) For Pb Free Product, AUO will add  for identification.
  - (2) For RoHs compatible products, AUO will add  for identification.
- Note: The green Mark will be present only when the green documents have been ready by AUO internal green team. (definition of green design follows the AUO green design checklist.)

#### B. Carton Label:

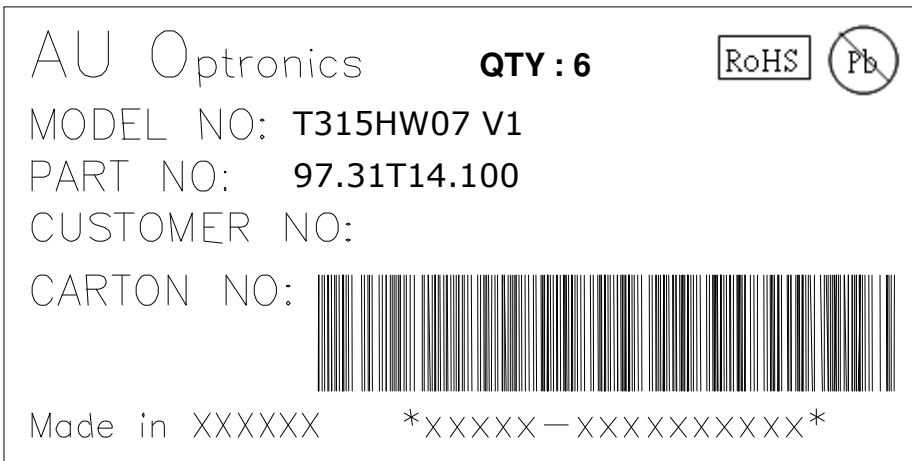



**8-2 PACKING METHODS:**

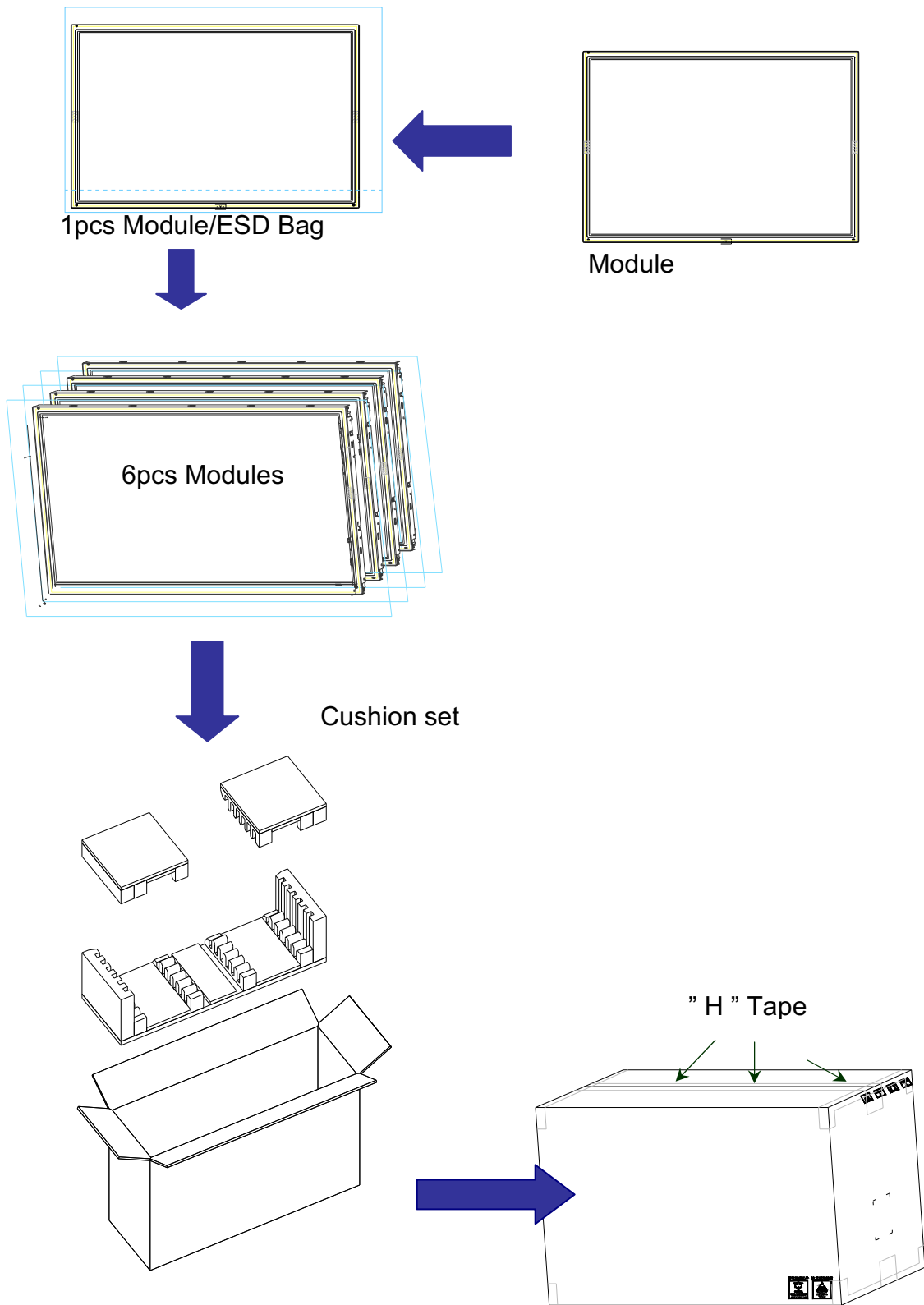

**8-3 Pallet and Shipment Information**

	Item	Specification			Packing Remark
		Quantity	Dimension	Weight (kg)	
1	Packing BOX	6pcs/box	830(L)mm*285(W)mm*537(H)mm	31	
2	Pallet	1	1150(L)mm*840(W)mm*132(H)mm	13	
3	Boxes per Pallet	8 boxes/Pallet			
4	Panels per Pallet	48 pcs/pallet			
5	Pallet after packing	N/A	1150(L)mm*840(W)mm*2460(H)mm	261	
			1150(L)mm*840(W)mm*2412(H)mm	522	
			Double Pallet		

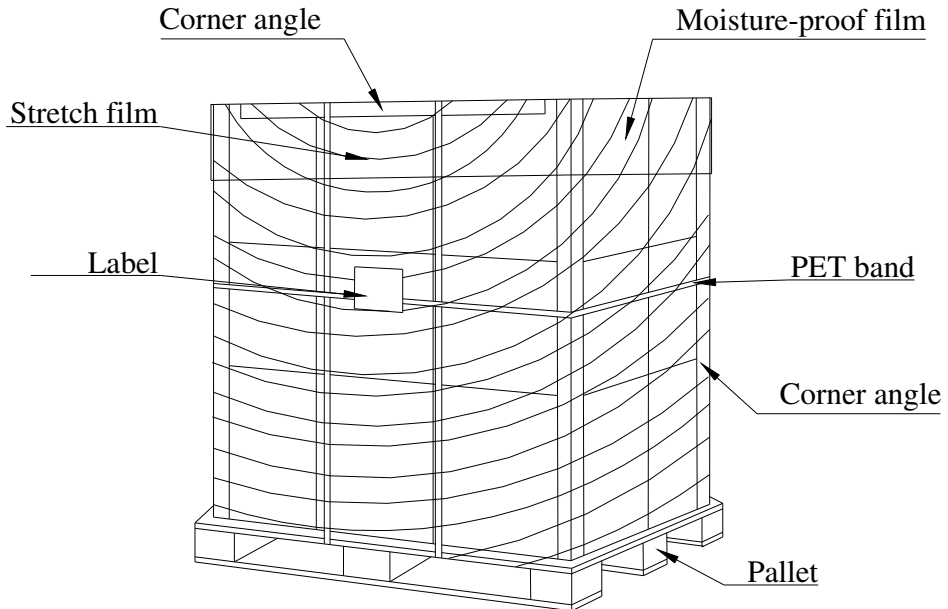

## 8. PRECAUTIONS

Please pay attention to the followings when you use this TFT LCD module.

### 9-1 MOUNTING PRECAUTIONS

- (1) You must mount a module using holes arranged in four corners or four sides.
- (2) You should consider the mounting structure so that uneven force (ex. twisted stress) is not applied to module. And the case on which a module is mounted should have sufficient strength so that external force is not transmitted directly to the module.
- (3) Please attach the surface transparent protective plate to the surface in order to protect the polarizer. Transparent protective plate should have sufficient strength in order to resist external force.
- (4) You should adopt radiation structure to satisfy the temperature specification.
- (5) Acetic acid type and chlorine type materials for the cover case are not desirable because the former generates corrosive gas of attacking the polarizer at high temperature and the latter causes circuit broken by electro-chemical reaction.
- (6) Do not touch, push or rub the exposed polarizer with glass, tweezers or anything harder than HB pencil lead. And please do not rub with dust clothes with chemical treatment. Do not touch the surface of polarizer for bare hand or greasy cloth. (Some cosmetics are detrimental to the polarizer.)
- (7) When the surface becomes dusty, please wipe gently with absorbent cotton or other soft materials like chamois soaked with petroleum benzene. Normal-hexane is recommended for cleaning the adhesives used to attach front/ rear polarizer. Do not use acetone, toluene and alcohol because they cause chemical damage to the polarizer.
- (8) Wipe off saliva or water drops as soon as possible. Their long time contact with polarizer causes deformations and color fading.
- (9) Do not open the case because inside circuits do not have sufficient strength.

### 9-2 OPERATING PRECAUTIONS

- (1) The device listed in the product specification sheets was designed and manufactured for TV application
- (2) The spike noise causes the mis-operation of circuits. It should be lower than following voltage:  
 $V = \pm 200\text{mV}$  (Over and under shoot voltage)
- (3) Response time depends on the temperature. (In lower temperature, it becomes longer..)
- (4) Brightness of CCFL depends on the temperature. (In lower temperature, it becomes lower.) And in lower temperature, response time (required time that brightness is stable after turned on) becomes longer.
- (5) Be careful for condensation at sudden temperature change. Condensation makes damage to polarizer or electrical contacted parts. And after fading condensation, smear or spot will occur.
- (6) When fixed patterns are displayed for a long time, remnant image is likely to occur.
- (7) Module has high frequency circuits. Sufficient suppression to the electromagnetic interference shall

be done by system manufacturers. Grounding and shielding methods may be important to minimize the interface.

### **9-3 ELECTROSTATIC DISCHARGE CONTROL**

Since a module is composed of electronic circuits, it is not strong to electrostatic discharge. Make certain that treatment persons are connected to ground through wristband etc. And don't touch interface pin directly.

### **9-4 PRECAUTIONS FOR STRONG LIGHT EXPOSURE**

Strong light exposure causes degradation of polarizer and color filter.

### **9-5 STORAGE**

When storing modules as spares for a long time, the following precautions are necessary.

- (1) Store them in a dark place. Do not expose the module to sunlight or fluorescent light. Keep the temperature between 5°C and 35°C at normal humidity.
- (2) The polarizer surface should not come in contact with any other object. It is recommended that they be stored in the container in which they were shipped.

### **9-6 HANDLING PRECAUTIONS FOR PROTECTION FILM**

- (1) The protection film is attached to the bezel with a small masking tape. When the protection film is peeled off, static electricity is generated between the film and polarizer. This should be peeled off slowly and carefully by people who are electrically grounded and with well ion-blown equipment or in such a condition, etc.
- (2) When the module with protection film attached is stored for a long time, sometimes there remains a very small amount of glue still on the bezel after the protection film is peeled off.
- (3) You can remove the glue easily. When the glue remains on the bezel or its vestige is recognized, please wipe them off with absorbent cotton waste or other soft material like chamois soaked with normal-hexane.

# Appendix 1

## EDID Setting

Item	Description	Value																																
<b>Vendor code</b>	Vendor Code 0 : - 1 : AUO	1																																
<b>Panel Inch</b>	Panel Inch, setting function: 21.6inch= 22 / 26inch= 26 32inch= 32 / 37inch= 37 40inch= 40 / 42inch= 42 46inch= 46 / 52inch= 52	32																																
<b>H.Resolution</b>	Panel Horizontal resolution information. 16bit : 0x02 = MS Byte, 0x03 = LS Byte (1) Horizontal resolution = 3840 (2) Horizontal resolution = 1920 (3) Horizontal resolution = 1366	1920																																
<b>V.Resolution</b>	Panel Vertical Resolution information: 16bit : 0x04 = MS Byte, 0x05 = LS Byte (1) Vertical resolution = 2160 (2) Vertical resolution = 1080 (3) Vertical resolution = 768	1080																																
<b>V. Frequency</b>	Panel Vertical frequency information. 0: 50Hz / 60Hz 1: 100Hz / 120Hz 2: 200Hz / 240Hz	1																																
<b>Data format</b>	Panel LVDS Data format information. 0: 8bit / 1: 8bit 2: 10bit / 3: 12bit 4: 14bit / 5: 16bit	2																																
<b>Part Number</b> <sup>*Note(1)</sup>	<p><b>Panel maker's version information.</b>                      @ Example: T260XW05 V0                      Item: (0), (1), (2), (3), (4), (5), (6), (7), (8), (9), (10), (11)                      "T", "2", "6", "0", "X", "W", "0", "5", " ", "V", "0", " ?"                      Ps: Item[11]: "?" , default is "空格欄".                      Setting value refer to "Note:(1)", and                      confirm with AUO: FAE and PM</p>	<table border="1"> <thead> <tr> <th>0</th><th>1</th><th>2</th><th>3</th><th>4</th><th>5</th><th>6</th><th>7</th><th>8</th><th>9</th><th>10</th><th>11</th><th>12</th><th>13</th><th>14</th><th>15</th> </tr> </thead> <tbody> <tr> <td>T</td><td>3</td><td>1</td><td>5</td><td>H</td><td>W</td><td>0</td><td>4</td><td></td><td>V</td><td>1</td><td></td><td></td><td></td><td></td><td></td> </tr> </tbody> </table> <p>Capitalization</p>	0	1	2	3	4	5	6	7	8	9	10	11	12	13	14	15	T	3	1	5	H	W	0	4		V	1					
0	1	2	3	4	5	6	7	8	9	10	11	12	13	14	15																			
T	3	1	5	H	W	0	4		V	1																								

## Appendix 2

### i. EMI specification

Model name: T315HW07 V1

Item	Min	Typ	Max	Unit
EMI level (Note)	---	---	-6	dB( $\mu$ V/m)
SSCG	---	350	---	ps

Note:

甲、Criteria: CISPR22

乙、Signal generator: PSG400 (Sony EMCS)

丙、EMI site: Sony EMCS Ichinomiya Tec. or using correlation value

丁、Find result should be checked by connecting with TV-set