



North/Latin America  
Europe/Africa  
Asia/Oceania

Internal Use Only

<http://aic.lgservice.com>  
<http://eic.lgservice.com>  
<http://biz.lgservice.com>

# LCD TV

# SERVICE MANUAL

CHASSIS : LD91D

MODEL : 32LH7000 32LH7000-ZA

## CAUTION

BEFORE SERVICING THE CHASSIS,  
READ THE SAFETY PRECAUTIONS IN THIS MANUAL.



# CONTENTS

<b>CONTENTS .....</b>	<b>2</b>
<b>PRODUCT SAFETY .....</b>	<b>3</b>
<b>SPECIFICATION .....</b>	<b>6</b>
<b>ADJUSTMENT INSTRUCTION .....</b>	<b>10</b>
<b>TROUBLE SHOOTING .....</b>	<b>15</b>
<b>BLOCK DIAGRAM.....</b>	<b>19</b>
<b>EXPLODED VIEW .....</b>	<b>20</b>
<b>SVC. SHEET .....</b>	

# SAFETY PRECAUTIONS

## IMPORTANT SAFETY NOTICE

Many electrical and mechanical parts in this chassis have special safety-related characteristics. These parts are identified by  $\triangle$  in the Schematic Diagram and Exploded View.

It is essential that these special safety parts should be replaced with the same components as recommended in this manual to prevent Shock, Fire, or other Hazards.

Do not modify the original design without permission of manufacturer.

### General Guidance

An **isolation Transformer should always be used** during the servicing of a receiver whose chassis is not isolated from the AC power line. Use a transformer of adequate power rating as this protects the technician from accidents resulting in personal injury from electrical shocks.

It will also protect the receiver and its components from being damaged by accidental shorts of the circuitry that may be inadvertently introduced during the service operation.

If any fuse (or Fusible Resistor) in this TV receiver is blown, replace it with the specified.

When replacing a high wattage resistor (Oxide Metal Film Resistor, over 1W), keep the resistor 10mm away from PCB.

Keep wires away from high voltage or high temperature parts.

### Before returning the receiver to the customer,

always perform an **AC leakage current check** on the exposed metallic parts of the cabinet, such as antennas, terminals, etc., to be sure the set is safe to operate without damage of electrical shock.

### Leakage Current Cold Check(Antenna Cold Check)

With the instrument AC plug removed from AC source, connect an electrical jumper across the two AC plug prongs. Place the AC switch in the on position, connect one lead of ohm-meter to the AC plug prongs tied together and touch other ohm-meter lead in turn to each exposed metallic parts such as antenna terminals, phone jacks, etc.

If the exposed metallic part has a return path to the chassis, the measured resistance should be between  $1M\Omega$  and  $5.2M\Omega$ .

When the exposed metal has no return path to the chassis the reading must be infinite.

An other abnormality exists that must be corrected before the receiver is returned to the customer.

### Leakage Current Hot Check (See below Figure)

Plug the AC cord directly into the AC outlet.

### Do not use a line Isolation Transformer during this check.

Connect 1.5K/10watt resistor in parallel with a 0.15 $\mu$ F capacitor between a known good earth ground (Water Pipe, Conduit, etc.) and the exposed metallic parts.

Measure the AC voltage across the resistor using AC voltmeter with 1000 ohms/volt or more sensitivity.

Reverse plug the AC cord into the AC outlet and repeat AC voltage measurements for each exposed metallic part. Any voltage measured must not exceed 0.75 volt RMS which corresponds to 0.5mA.

In case any measurement is out of the limits specified, there is possibility of shock hazard and the set must be checked and repaired before it is returned to the customer.

### Leakage Current Hot Check circuit

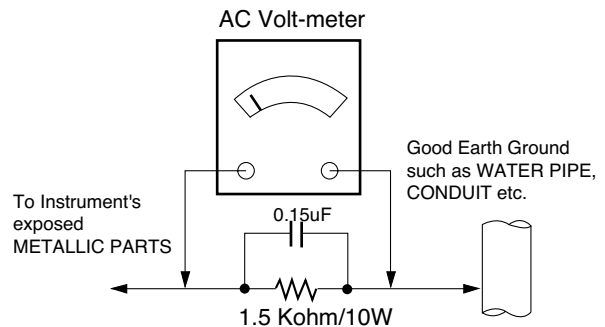

When 25A is impressed between Earth and 2nd Ground for 1 second, Resistance must be less than  $0.1\Omega$

\*Base on Adjustment standard

# SERVICING PRECAUTIONS

**CAUTION:** Before servicing receivers covered by this service manual and its supplements and addenda, read and follow the SAFETY PRECAUTIONS on page 3 of this publication.

**NOTE:** If unforeseen circumstances create conflict between the following servicing precautions and any of the safety precautions on page 3 of this publication, always follow the safety precautions. Remember: Safety First.

## General Servicing Precautions

1. Always unplug the receiver AC power cord from the AC power source before;
  - a. Removing or reinstalling any component, circuit board module or any other receiver assembly.
  - b. Disconnecting or reconnecting any receiver electrical plug or other electrical connection.
  - c. Connecting a test substitute in parallel with an electrolytic capacitor in the receiver.  
**CAUTION:** A wrong part substitution or incorrect polarity installation of electrolytic capacitors may result in an explosion hazard.
2. Test high voltage only by measuring it with an appropriate high voltage meter or other voltage measuring device (DVM, FETVOM, etc) equipped with a suitable high voltage probe. Do not test high voltage by "drawing an arc".
3. Do not spray chemicals on or near this receiver or any of its assemblies.
4. Unless specified otherwise in this service manual, clean electrical contacts only by applying the following mixture to the contacts with a pipe cleaner, cotton-tipped stick or comparable non-abrasive applicator; 10% (by volume) Acetone and 90% (by volume) isopropyl alcohol (90%-99% strength)  
**CAUTION:** This is a flammable mixture.  
Unless specified otherwise in this service manual, lubrication of contacts is not required.
5. Do not defeat any plug/socket B+ voltage interlocks with which receivers covered by this service manual might be equipped.
6. Do not apply AC power to this instrument and/or any of its electrical assemblies unless all solid-state device heat sinks are correctly installed.
7. Always connect the test receiver ground lead to the receiver chassis ground before connecting the test receiver positive lead.  
Always remove the test receiver ground lead last.
8. Use with this receiver only the test fixtures specified in this service manual.  
**CAUTION:** Do not connect the test fixture ground strap to any heat sink in this receiver.

## Electrostatically Sensitive (ES) Devices

Some semiconductor (solid-state) devices can be damaged easily by static electricity. Such components commonly are called Electrostatically Sensitive (ES) Devices. Examples of typical ES devices are integrated circuits and some field-effect transistors and semiconductor "chip" components. The following techniques should be used to help reduce the incidence of component damage caused by static by static electricity.

1. Immediately before handling any semiconductor component or semiconductor-equipped assembly, drain off any electrostatic charge on your body by touching a known earth ground. Alternatively, obtain and wear a commercially available discharging wrist strap device, which should be removed to prevent potential shock reasons prior to applying power to the

unit under test.

2. After removing an electrical assembly equipped with ES devices, place the assembly on a conductive surface such as aluminum foil, to prevent electrostatic charge buildup or exposure of the assembly.
3. Use only a grounded-tip soldering iron to solder or unsolder ES devices.
4. Use only an anti-static type solder removal device. Some solder removal devices not classified as "anti-static" can generate electrical charges sufficient to damage ES devices.
5. Do not use freon-propelled chemicals. These can generate electrical charges sufficient to damage ES devices.
6. Do not remove a replacement ES device from its protective package until immediately before you are ready to install it. (Most replacement ES devices are packaged with leads electrically shorted together by conductive foam, aluminum foil or comparable conductive material).
7. Immediately before removing the protective material from the leads of a replacement ES device, touch the protective material to the chassis or circuit assembly into which the device will be installed.  
**CAUTION:** Be sure no power is applied to the chassis or circuit, and observe all other safety precautions.
8. Minimize bodily motions when handling unpackaged replacement ES devices. (Otherwise harmless motion such as the brushing together of your clothes fabric or the lifting of your foot from a carpeted floor can generate static electricity sufficient to damage an ES device.)

## General Soldering Guidelines

1. Use a grounded-tip, low-wattage soldering iron and appropriate tip size and shape that will maintain tip temperature within the range or 500°F to 600°F.
2. Use an appropriate gauge of RMA resin-core solder composed of 60 parts tin/40 parts lead.
3. Keep the soldering iron tip clean and well tinned.
4. Thoroughly clean the surfaces to be soldered. Use a mall wire-bristle (0.5 inch, or 1.25cm) brush with a metal handle. Do not use freon-propelled spray-on cleaners.
5. Use the following unsoldering technique
  - a. Allow the soldering iron tip to reach normal temperature. (500°F to 600°F)
  - b. Heat the component lead until the solder melts.
  - c. Quickly draw the melted solder with an anti-static, suction-type solder removal device or with solder braid.  
**CAUTION:** Work quickly to avoid overheating the circuit board printed foil.
6. Use the following soldering technique.
  - a. Allow the soldering iron tip to reach a normal temperature (500°F to 600°F)
  - b. First, hold the soldering iron tip and solder the strand against the component lead until the solder melts.
  - c. Quickly move the soldering iron tip to the junction of the component lead and the printed circuit foil, and hold it there only until the solder flows onto and around both the component lead and the foil.  
**CAUTION:** Work quickly to avoid overheating the circuit board printed foil.
  - d. Closely inspect the solder area and remove any excess or splashed solder with a small wire-bristle brush.

## IC Remove/Replacement

Some chassis circuit boards have slotted holes (oblong) through which the IC leads are inserted and then bent flat against the circuit foil. When holes are the slotted type, the following technique should be used to remove and replace the IC. When working with boards using the familiar round hole, use the standard technique as outlined in paragraphs 5 and 6 above.

### Removal

1. Desolder and straighten each IC lead in one operation by gently prying up on the lead with the soldering iron tip as the solder melts.
2. Draw away the melted solder with an anti-static suction-type solder removal device (or with solder braid) before removing the IC.

### Replacement

1. Carefully insert the replacement IC in the circuit board.
2. Carefully bend each IC lead against the circuit foil pad and solder it.
3. Clean the soldered areas with a small wire-bristle brush. (It is not necessary to reapply acrylic coating to the areas).

## "Small-Signal" Discrete Transistor Removal/Replacement

1. Remove the defective transistor by clipping its leads as close as possible to the component body.
2. Bend into a "U" shape the end of each of three leads remaining on the circuit board.
3. Bend into a "U" shape the replacement transistor leads.
4. Connect the replacement transistor leads to the corresponding leads extending from the circuit board and crimp the "U" with long nose pliers to insure metal to metal contact then solder each connection.

## Power Output, Transistor Device

### Removal/Replacement

1. Heat and remove all solder from around the transistor leads.
2. Remove the heat sink mounting screw (if so equipped).
3. Carefully remove the transistor from the heat sink of the circuit board.
4. Insert new transistor in the circuit board.
5. Solder each transistor lead, and clip off excess lead.
6. Replace heat sink.

## Diode Removal/Replacement

1. Remove defective diode by clipping its leads as close as possible to diode body.
2. Bend the two remaining leads perpendicular y to the circuit board.
3. Observing diode polarity, wrap each lead of the new diode around the corresponding lead on the circuit board.
4. Securely crimp each connection and solder it.
5. Inspect (on the circuit board copper side) the solder joints of the two "original" leads. If they are not shiny, reheat them and if necessary, apply additional solder.

## Fuse and Conventional Resistor

### Removal/Replacement

1. Clip each fuse or resistor lead at top of the circuit board hollow stake.
2. Securely crimp the leads of replacement component around notch at stake top.
3. Solder the connections.

**CAUTION:** Maintain original spacing between the replaced component and adjacent components and the circuit board to prevent excessive component temperatures.

## Circuit Board Foil Repair

Excessive heat applied to the copper foil of any printed circuit board will weaken the adhesive that bonds the foil to the circuit board causing the foil to separate from or "lift-off" the board. The following guidelines and procedures should be followed whenever this condition is encountered.

### At IC Connections

To repair a defective copper pattern at IC connections use the following procedure to install a jumper wire on the copper pattern side of the circuit board. (Use this technique only on IC connections).

1. Carefully remove the damaged copper pattern with a sharp knife. (Remove only as much copper as absolutely necessary).
2. Carefully scratch away the solder resist and acrylic coating (if used) from the end of the remaining copper pattern.
3. Bend a small "U" in one end of a small gauge jumper wire and carefully crimp it around the IC pin. Solder the IC connection.
4. Route the jumper wire along the path of the out-away copper pattern and let it overlap the previously scraped end of the good copper pattern. Solder the overlapped area and clip off any excess jumper wire.

### At Other Connections

Use the following technique to repair the defective copper pattern at connections other than IC Pins. This technique involves the installation of a jumper wire on the component side of the circuit board.

1. Remove the defective copper pattern with a sharp knife. Remove at least 1/4 inch of copper, to ensure that a hazardous condition will not exist if the jumper wire opens.
  2. Trace along the copper pattern from both sides of the pattern break and locate the nearest component that is directly connected to the affected copper pattern.
  3. Connect insulated 20-gauge jumper wire from the lead of the nearest component on one side of the pattern break to the lead of the nearest component on the other side. Carefully crimp and solder the connections.
- CAUTION:** Be sure the insulated jumper wire is dressed so the it does not touch components or sharp edges.

# SPECIFICATION

NOTE : Specifications and others are subject to change without notice for improvement.

## 1. Application range

This specification is applied to the LCD TV used LD91D chassis.

## 2. Requirement for Test

Each part is tested as below without special appointment.

- 1) Temperature : 25±5°C (77±9°F), CST : 40±5°C
- 2) Relative Humidity : 65±10%
- 3) Power Voltage : Standard input voltage(100~240V@50/60Hz)  
\* Standard Voltage of each products is marked by models.
- 4) Specification and performance of each parts are followed each drawing and specification by part number in accordance with BOM.
- 5) The receiver must be operated for about 5 minutes prior to the adjustment.

## 3. Test method

- 1) Performance: LGE TV test method followed
- 2) Demanded other specification
  - Safety: CE/IEC specification
  - EMC: CE/IEC

## 4. General specification

No	Item Specification			Remark
1	Display Screen Device	32 wide Color Display Module		LCD
2	Aspect Ratio	16:9		
3	LCD Module	32" TFT LCD FHD 100Hz		LGD
4	Operating Environment	Temp. : 0 ~50 deg		
		Humidity : 20 ~90 %		
5	Storage Environment	Temp. : -20 ~60 deg		
		Humidity : 10 ~90 %		
6	Input Voltage	AC100-240V~, 50/60Hz		
7	Power consumption	Power on (White)		
		32" LGD	Typ : 110, Max : 120	LCD(Module) + Backlight(Lamp)
8	Module Size	32" LGD	760.0(H) x 450.0(V) x 48.00mm(D)	With inverter
9	Pixel Pitch	32" LGD	0.36375(H) x 0.36375(V)	
10	Backlight	16 EEFL		
11	Display Colors	1.06B(true) colors		
12	Coating 3H(Hard	coating)		

## 5. Chroma& Brightness

### (1) Module optical specification

No.	Item Specification		Min.	Typ.	Max.	Remark	
1.	Viewing Angle<CR>10>	Right/Left/Up/Down	89/89 89/89			CR>10	
2.	Luminance	Luminance (cd/m2)	400	500		PSM:Vivid,CSM:Cool, White(100IRE) Dynamic contrast :off Dynamic color L off	
		Variation 1.3				MAX /MIN	
3.	Contrast Ratio	CR	900	1300			
4.	CIE Color Coordinates	White	Wx	Typ -0.03	0.279	Typ +0.03	PSM:Vivid,CSM:Cool, White(85IRE) Dynamic contrast :off Dynamic color L off
			Wy		0.292		
		RED	Xr	0.638			
			Yr	0.334			
		Green	Xg 0.291				
			Yg 0.607				
		Blue	Xb 0.145				
			Yb	0.062			

1) Stable for approximately 60 minutes in a dark environment at 25°C

2) Operating Ambient Humidity : Min 10, Max 90 %RH

3) Supply Voltage : 24V

4) Frame Frequency : 120Hz

### (2) Chroma (PSM: Vivid, Color Temperature: Cool)

- except "RGB PC Mode PSM:Standard,Color Temperature:Medium"

\*\*The W/B Tolerance is  $\pm 0.002$  for Adjustment, but for DQA  $\pm 0.015$

No Item		Min	Typ	Max	Remark	
1.	Cool	White Balance,X axis	0.274	0.276	0.278	DQA : $\pm 0.015$
		White Balance,Y axis	0.281	0.283	0.285	DQA : $\pm 0.015$
2.	Medium	White Balance,X axis	0.283	0.285	0.287	DQA : $\pm 0.015$
		White Balance,Y axis	0.291	0.293	0.295	DQA : $\pm 0.015$
3.	Warm	White Balance,X axis	0.311	0.313	0.315	DQA : $\pm 0.015$
		White Balance,Y axis	0.327	0.329	0.331	DQA : $\pm 0.015$

### (3) SET Optical Feature

#### 1) General feature

No Item	Module	Luminance (min)	C/R(min)	Remark
		AV,COMPONENT,HDMI	AV,COMPONENT,HDMI	
1.	32 inch LGD	400cd/m <sup>2</sup>	900	except from the PC mode.

\* Measurement Condition: Full white/Dynamic) -> Measure the black luminance after 30 seconds.

#### 2) Special feature (Dynamic CR 15000:1)

No	Item	Min	typ	Max	Inch	Power Board P/N	Remark
1	Dynamic CR (Only HDMI mode)	10000	15000		32"	EAY58473201	HDMI 720p Full Black Pattern

## 6. Component Video Input (Y, PB, PR)

No	Specification			Remark
	Resolution	H-freq(kHz)	V-freq(Hz)	
1.	720x480 15.73		60.00	SDTV,DVD 480i
2.	720x480 15.63		59.94	SDTV,DVD 480i
3.	720x480 31.47		59.94	480p
4.	720x480 31.50		60.00	480p
5.	720x576	15.625	50.00	SDTV,DVD 625 Line
6.	720x576 31.25		50.00	HDTV 576p
7.	1280x720 45.00		50.00	HDTV 720p
8.	1280x720 44.96		59.94	HDTV 720p
9.	1280x720 45.00		60.00	HDTV 720p
10.	1920x1080	31.25	50.00	HDTV 1080i
11.	1920x1080 33.75		60.00	HDTV 1080i
12.	1920x1080 33.72		59.94	HDTV 1080i
13.	1920x1080 26.97/27		23.97/24	HDTV 1080p
14.	1920x1080 33.716/33.75		29.976/30.00	HDTV 1080p
15.	1920x1080 56.250		50	HDTV 1080p
16.	1920x1080 67.43/67.5		59.94/60	HDTV 1080p

## 7. RGB PC INPUT

No	Resolution	H-freq(kHz)	V-freq.(Hz)	Pixel clock(MHz)	Proposed	Remark
1.	720x400 31.468		70.08	28.321		
2.	640x480 31.469		59.94	25.17	VESA	
		37.684 75.00		31.50		
3.	800x600	37.879	60.31	40.00	VESA	
		46.875 75.00		49.50		
4.	832x624 49.725		74.55	57.283	Macintosh	
5.	1024x768	48.363	60.00	65.00	VESA(XGA)	
		56.470 70.00		75.00		
		60.123	75.029	78.75		
6.	1280x768	47.78	59.87	79.5	WXGA	
7.	1360x768	47.72	59.8	84.75	WXGA	
8.	1366x768	47.56	59.6	84.75	WXGA	
9.	1280x1024	63.595	60.0	108.875	SXGA	
10.	1920x1080	66.647	59.988	138.625	WUXGA	



## 8. HDMI Input (PC/DTV)

### (1) DTV Mode

No	Resolution	H-freq(kHz)	V-freq.(Hz)	Pixel clock(MHz)	Proposed	Remark
1	720x480	15.734 /15.6	59.94 /60	27.00	SDTV 480I	
2	720x480	31.469 /31.5	59.94 /60	27.00/27.03	SDTV 480P	
3	720x576	15.625	50	27(54)	SDTV 576	
4	720x576	31.25	50	54	SDTV 576P	
5	1280x720	37.500	50	74.25	HDTV 720P	
6	1280x720	44.96 /45	59.94 /60	74.17/74.25	HDTV 720P	
7	1920x1080	33.72 /33.75	59.94 /60	74.17/74.25	HDTV 1080I	
8	1920x1080	28.125	50.00	74.25	HDTV 1080I	
9	1920x1080	26.97 /27	23.97 /24	74.17/74.25	HDTV 1080P	
10	1920x1080	33.716 /33.75	29.976 /30.00	74.25	HDTV 1080P	
11	1920x1080 56.250		50	148.5	HDTV 1080P	
12	1920x1080	67.43 /67.5	59.94 /60	148.35/148.50	HDTV 1080P	

### (2) PC Mode

No	Resolution	H-freq(kHz)	V-freq.(Hz)	Pixel clock(MHz)	Proposed	Remark
1	720x400 31.468		70.08	28.321		HDCP
2	640x480	31.469 59.94 37.684 75.00		25.17 31.50	VESA	HDCP
3	800x600	37.879 60.31 46.875	75.00	40.00 49.50	VESA	HDCP
4	832x624 49.725		74.55	57.283	Macintosh	HDCP
5	1024x768	48.363 56.470 70.00 60.123	60.00 75.029	65.00 75.00 78.75	VESA(XGA)	HDCP
6	1280x768	47.78	59.87	79.5	WXGA	HDCP
7	1360x768	47.72	59.8	84.75	WXGA	HDCP
8	1366x768	47.56	59.6	84.75	WXGA	HDCP
9	280x1024	63.595	60.0	108.875	SXGA	HDCP
10	1920x1080	66.647	59.988	138.625	WUXGA	HDCP

# ADJUSTMENT INSTRUCTION

## 1. Application Range

This specification sheet is applied to all of the LCD TV with LD91D chassis.

## 2. Designation

- 1) The adjustment is according to the order which is designated and which must be followed, according to the plan which can be changed only on agreeing.
- 2) Power Adjustment: Free Voltage
- 3) Magnetic Field Condition: Nil.
- 4) Input signal Unit: Product Specification Standard
- 5) Reserve after operation: Above 5 Minutes (Heat Run)  
Temperature : at 25±5°C  
Relative humidity : 65±10%  
Input voltage : 220V, 60Hz
- 6) Adjustment equipments: Color Analyzer (CA-210 or CA-110), Pattern Generator(MSPG-925 series or Equivalent)  
DDC Adjustment Jig equipment, SVC remote controller
- 7) Push The "IN STOP KEY" - For memory initialization.

### Case1 : Software version up

1. After downloading S/W by USB , TV set will reboot automatically
2. Push "In-stop" key
3. Push "Power on" key
4. Function inspection
5. After function inspection, Push "I n-stop" key.

### Case2 : Function check at the assembly line

1. When TV set is entering on the assembly line, Push "In-stop" key at first.
2. Push "Power on" key for turning it on.  
-> If you push "Power on" key, TV set will recover channel information by itself.
3. After function inspection, Push "In-stop" key.

## 3. Main PCB check process

\* APC - After Manual-Insult, executing APC

### \* Boot file Download

- 1) Execute ISP program "Mstar ISP Utility" and then click "Config" tab.
- 2) Set as below, and then click "Auto Detect" and check "OK" message  
If "Error" is displayed, Check connection between computer, jig, and set.
- 3) Click "Read" tab, and then load download file (XXXX.bin) by clicking "Read"

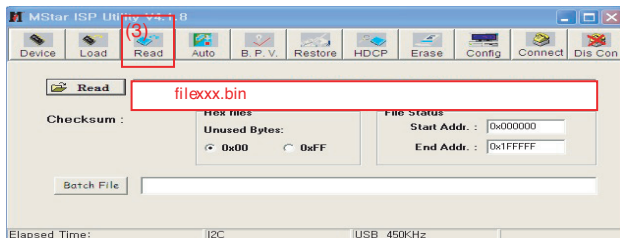

- 4) Click "Connect" tab. If "Can't" is displayed, Check connection between computer, jig, and set.

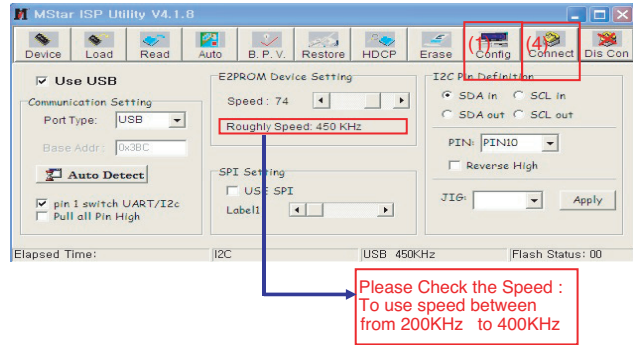

- 5) Click "Auto" tab and set as below
- 6) Click "Run".
- 7) After downloading, check "OK" message.

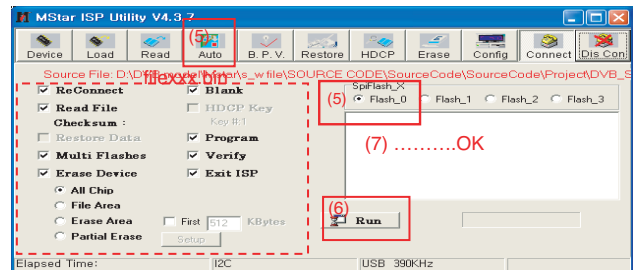

### \* USB DOWNLOAD

- 1) Put the USB Stick to the USB socket.
- 2) Automatically detecting update file in USB Stick.  
- If your downloaded program version in USB Stick is Low, it didn't work. But your downloaded version is High, USB data is automatically detecting.
- 3) Show the message "Copying files from memory".

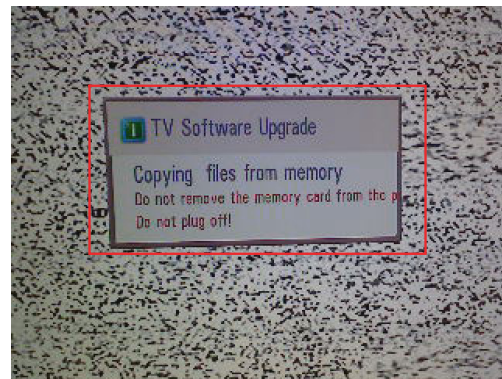

4) Updating is starting.

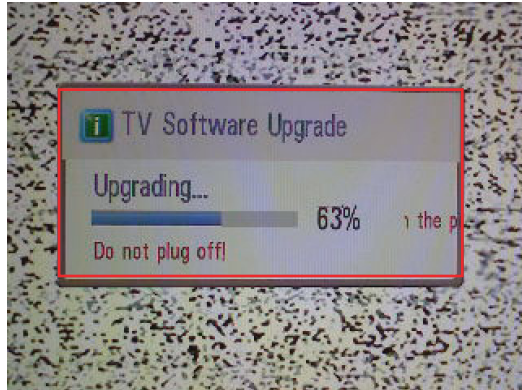

- 5) Fishing the version uploading, you have to put USB stick and "AC Power" off.
  - 6) After putting "AC Power" on and check updated version on your TV.
- \* If downloading version is more high than your TV have, TV can lost all channel data. In this case, you have to channel recover. if all channel data is cleared, you didn't have a DTV/ATV test on production line.

\* After downloading, have to adjust T OOL OPTION again.

- 1) Push "IN-START" key in service remote controller
- 2) Select "Tool Option 1" and Push "OK" button.
- 3) Punch in the number. (Each model has their number)

Tool	1	2	3	4
Option	13824	3382	56744	2304

4) Completed selecting Tool option.

### 3.1. ADC Process

- (1) External ADC (Only adjust in the component mode 480I)
  - Input the Signal in the Component 1 -Component 480I (Adjusted only this mode)
  - MODEL: 209 in Pattern Generator(480i Mode)
  - PATTERN : 65 in Pattern Generator( MSPG-925 Series)

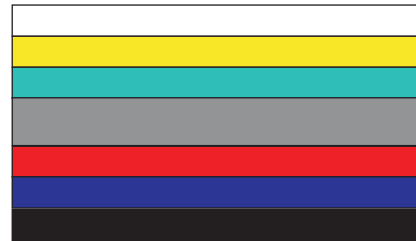

<Adjustment pattern(PC)>

- After enter Service Mode by pushing "ADJ" key,
  - Enter the 5 item and then Push the "Start" button
- (2) Internal ADC(Only adjust in the RGB mode)
    - After enter Service Mode by pushing "ADJ" key
    - Enter ADC Calibration mode by pushing "▶" key at "5. ADC Calibration"
    - Push the Start button
  - (3) Function Check
    - Check display and sound
    - Check Input and Signal items. (cf. work instructions)
    - 1) TV
    - 2) AV (SCART1/SCART2/ CVBS)
    - 3) COMPONENT (480i)
    - 4) RGB (PC : 1024 x 768 @ 60hz)
    - 5) HDMI
    - 6) PC Audio In
    - \* Display and Sound check is executed by Remote controller.

## 4. Total Assembly line process

### 4.1. Adjustment Preparation

- W/B Equipment condition
- CA210 : CH 9, Test signal : Inner pattern (85IRE)
- Above 5 minutes H/run in the inner pattern. ("power on" key of adjust remote control)

Cool	11,000k	°K	X=0.276(±0.002)	<Test Signal>
			Y=0.283(±0.002)	
Medium	9,300k	°K	X=0.285(±0.002)	Inner pattern (216gray,85IRE)
			Y=0.293(±0.002)	
Warm	6,500k	°K	X=0.313(±0.002)	
			Y=0.329(±0.002)	

- \* Connecting picture of the measuring instrument (On Automatic control )  
Inside PATTERN is used when W/B is controlled. Connect to auto controller or push Adjustment R/C POWER ON -> Enter the mode of White-Balance, the pattern will come out.

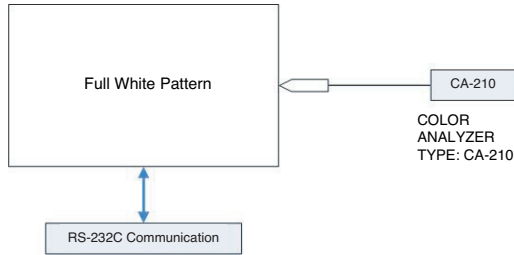

<Connecting picture ( On Automatic Control)>

- \*Auto-control interface and directions
  - 1) Adjust in the place where the influx of light like floodlight around is blocked. (illumination is less than 10ux).
  - 2) Adhere closely the Color Analyzer (CA210) to the module less than 10cm distance, keep it with the surface of the Module and Color Analyzer's Prove vertically.(80~100°).
  - 3) Aging time
    - After aging start, keep the power on (no suspension of power supply) and heat-run over 15minutes.
    - Using 'no signal' or 'full white pattern' or the others, check the back light on.

• Auto adjustment Map(RS-232C)

	RS-232C COMMAND			CENTER				MAX
	[CMD ID DATA]			(DEFAULT)				
	Cool	Mid	Warm	MIN	Cool	Mid	Warm	
R Gain	jg	Ja	jd	00	172	192	192	255
G Gain	jh	Jb	je	00	172	192	192	255
B Gain	ji	Jc	jf	00	192	192	172	255
R Cut					64	64	64	128
G Cut					64	64	64	128
B Cut					64	64	64	128

\*\* Caution \*\*  
Color Temperature : COOL, Medium, Warm.  
One of R Gain/G Gain/ B Gain should be kept on 0xC0, and adjust other two lower than C0.  
(when R/G/B Gain are all C0, it is the FULL Dynamic Range of Module)

- \* Manual W/B process using adjusts Remote control.
  - After enter Service Mode by pushing “ADJ” key,
  - Enter White Balance by pushing “▶” key at “3. White Balance”.



- \* After done all adjustments, Press “In-start” button and compare Tool option and Area option value with its BOM, if it is correctly same then unplug the AC cable. If it is not same, then correct it same with BOM and unplug AC cable. For correct it to the model’s module from factory JIG model.
- \* Push The “IN STOP” key after completing the function inspection.

## 4.2. DPM operation confirmation

(Only Apply for MNT Model)

- Check if Power LED Color and Power Consumption operate as standard.
- Set Input to RGB and connect D-sub cable to set
- Measurement Condition: (100~240V@ 50/60Hz)
- Confirm DPM operation at the state of screen without Signal.

## 4.3. DDC EDID Write (RGB 128Byte )

- Write EDID DATA to EEPROM (24C02) by using DDC2B protocol.
- Check whether written EDID data is correct or not.
- \* For SVC main Ass’y, EDID have to be downloaded to Insert Process in advance.

## 4.4. DDC EDID Write (HDMI 256Byte)

- Check whether written EDID data is correct or not.
- \* For SVC main Ass’y, EDID have to be downloaded to Insert Process in advance.

## 4.5. EDID DATA

- 1) All Data : HEXA Value
- 2) Changeable Data :
  - \*: Serial No : Controlled / Data:01
  - \*\* : Month : Controlled / Data:00
  - \*\*\*:Year : Controlled
  - \*\*\*\*:Check sum

### - Auto Download

- After enter Service Mode by pushing “ADJ” key,
- Enter EDID D/L mode.
- Enter “START” by pushing “OK” key.
- \* Caution
  - Never connect HDMI & D-sub Cable when the user downloading .
  - Use the proper cables below for EDID Writing.

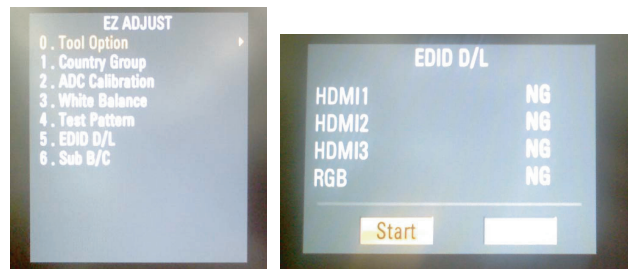

\* Edid data and Model option download (RS232)

NO.	Item	CMD1	CMD2	Data 0	
Enter download MODE	Download 'Modeln'	A	E	0	0
When transfer the 'Mode In', Carry the command.					
Edid data and Model option download	Download	A	E	*Note1	*Note2
Automatically download (The use of a internal Data)					
	Adjust 'Mode Out'	A	E	9	0
	Adjustment Confirmation	A	E	9	9
To check Download on Assembly line.					

- Manual Download

\* Caution

Use the proper signal cable for EDID Download

- Analog EDID : Pin3 exists
- Digital EDID : Pin3 exists

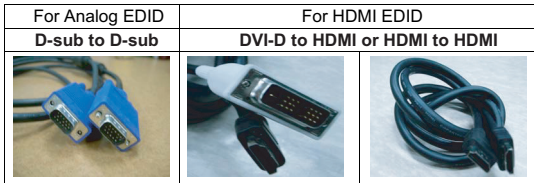

No.	Item	Condition	Hex Data
1	Manufacturer ID	GSM	1E6D
2	Version	Digital : 1	01
3	Revision	Digital : 3	03

(1) Analog Data 128Byte (2Bi)

	0x00	0x01	0x02	0x03	0x04	0x05	0x06	0x07	0x08	0x09	0x0A	0x0B	0x0C	0x0D	0x0E	0x0F
0x00	00	FF	FF	FF	FF	FF	0	1E	6D	Ⓒ		Ⓓ				
0x01	Ⓒ	01	03	08	44	27	78	EA	D9	B0	A3	57	49	9C	25	
0x02	11	49	4B	A5	6E	00	31	44	40	61	40	81 (D1)	80 (C0)	90 (01)	40 (01)	
0x03	D1 (01)	C0 (01)	01 0	01	01	1A (1B)	36 (21)	80 (50)	A0 (A0)	70 (51)	38 (00)	1F (1E)	40 (30)	30 (48)	20 (88)	
0x04	35 00	E8 (BC)	26 (86)	32 (21)	00 00	1A (1C)	DA (26)	2F (36)	78 (80)	E0 (A0)	51 (70)	1A (38)	25 (1F)	40 (40)		
0x05	58 (50)	98 (20)	14 (85)	00 (00)	E8 (BC)	26 (86)	32 (21)	00 00	1A (18)	00 (00)	00 (00)	00 (00)	FD (FC)	00 (00)	39 (33)	
0x06	4B (32)	1F (4C)	54 (47)	12 (35)	00 (35)	0A (30)	20 (30)	20 (0A)	20 20	20	20	Ⓓ				
0x07	Ⓓ														00	Ⓔ

(2) DIGITAL DATA(HDMI-1/2/3/4) 256Byte

	0x00	0x01	0x02	0x03	0x04	0x05	0x06	0x07	0x08	0x09	0x0A	0x0B	0x0C	0x0D	0x0E	0x0F
0x00	00	FF	FF	FF	FF	FF	0	1E	6D	Ⓒ		Ⓓ				
0x01	Ⓒ	01	03	80	46	27	78	EA	D9	B0	A3	57	49	9C	25	
0x02	11	49	4B	A5	6E	00	31	40	45	40	61	40	81 (D1)	80 (C0)	90 (01)	40 (01)
0x03	A9 (01)	40 (01)	D1 (01)	C0 (01)	01 0	01	1A (02)	36 (3A)	80 (80)	A0 (18)	70 (71)	38 (38)	1F (2D)	40 (40)	30 (58)	20 (2C)
0x04	35 (45)	00 (00)	E8 (C4)	26 (8E)	32 (21)	00 (00)	00 (00)	1A (1E)	1B 21	50	A0	51	00	1E	30	
0x05	48 88	35	00	BC	86	21	00	00	1C	00 (00)	00 (00)	00 (00)	00 (00)	FD (FC)	00 (00)	39 (33)
0x06	4B (32)	1F (4C)	54 (47)	12 (35)	00 (35)	0A (30)	20 (30)	20 (0A)	20 20	20	20	Ⓓ				
0x07	Ⓓ														01	Ⓔ

	0x00	0x01	0x02	0x03	0x04	0x05	0x06	0x07	0x08	0x09	0x0A	0x0B	0x0C	0x0D	0x0E	0x0F
0x00	02 04	23 (21)	F1 4E	81 (02)	02 (11)	03 (01)	15 (03)	12 14	04	14	05	20 (21)	21 (1F)			
0x01	22 (20)	1F (22)	10 23	09	07	83 04	00	Ⓓ								
0x02	Ⓓ		01 (00)	1D (BC)	00 (52)	80 (D0)	51 (1E)	D0 (20)	1C (B8)	20 (28)	40 (55)	80 (40)	35 (C4)	00 (8E)	BC (21)	
0x03	88 (00)	21 (00)	00 (1E)	00 (01)	1E (1D)	8C (00)	0A (72)	D0 (51)	8A (D0)	20 (1E)	E0 (20)	2D (6E)	10 (28)	10 (55)	3E (00)	96 (C4)
0x04	00 (8E)	13 (21)	8E (00)	21 (00)	00 (1E)	00 (01)	18 (1D)	02 (80)	3A (D0)	80 (72)	18 (1C)	71 (16)	38 (20)	2D (10)	40 (2C)	58 (25)
0x05	2C (80)	45 (C4)	00 (8E)	06 (21)	00 (00)	44 (00)	21 (9E)	00 (8C)	1E (0A)	01 (D0)	FD (90)	80 (20)	18 (40)	71 (31)	1C (20)	16 (0C)
0x06	20 (40)	58 (65)	2C (00)	25 (C4)	00 (8E)	21 (21)	00 (00)	21 (00)	00 (18)	00 (4E)	9E (1F)	4E (00)	1F (80)	51 (51)	80 (00)	51 (1E)
0x07	00 (30)	1E (40)	30 (80)	40 (37)	00 (00)	80 (BC)	37 (88)	00 (21)	88 (00)	21 (00)	00 14	00	00	00	00	Ⓔ

\* Detail EDID Options are below

Product ID

Product ID	HEX	EDID Table	DDC Function
40450 0x9E02		029E	Analog
40451	0x9E03	039E	Digital

Serial No: Controlled on production line.

Month, Year : Controlled on production line:

ex) Monthly : '09' -> '09'

Year : '2006' -> '10'

Model Name(Hex):

MODEL	MODEL NAME(HEX)
42LH7000	00 00 00 FC 00 34 32 4C 48 37 30 30 30 0A 20 20 20 20

Checksum: Changeable by total EDID data.

Vendor Specific(HDMI)

INPUT	MODEL NAME(HEX)
HDMI1	67030C001000B82D
HDMI2	67030C002000B82D
HDMI3	67030C003000B82D
HDMI4	67030C004000B82D

4.6. Outgoing condition Configuration

- When pressing IN-STOP key by SVC mocon, Red LED are blinked alternatively. And then Automatically turn off. (Must not AC power OFF during blinking)

4.7. Internal pressure

Confirm whether is normal or not when between power board's ac block and GND is impacted on 1.5kV(dc) or 2.2kV(dc) for one second

## 5. Serial number D/L

- press “Power on” key of service remocon.  
(Baud rate : 115200 bps)
- Connect RS232 Signal Cable to RS-232 Jack.
- Write Serial number by use RS-232.
- Must check the serial number at the Diagnostics of SET UP menu. (Refer to below).

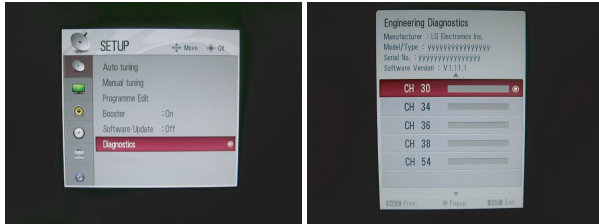

### 5.1. Signal TABLE

CMD	LENGTH	ADH	ADL	DATA_1	...	Data_n	CS	DELAY
-----	--------	-----	-----	--------	-----	--------	----	-------

CMD : A0h

LENGTH : 85~94h (1~16 bytes)

ADH : EEPROM Sub Address high (00~1F)

ADL : EEPROM Sub Address low (00~FF)

Data : Write data

CS : CMD + LENGTH + ADH + ADL + Data\_1 + ... + Data\_n

Delay : 20ms

### 5.2. Command Set

No.	Adjust mode	CMD(hex)	LENGTH(hex)	Description
1	EEPROM WRITE	A0h	84h+n	n-bytes Write (n = 1~16)

\* Description

FOS Default write : <7mode data> write

Vtotal, V\_Frequency, Sync\_Polarity, Htotal, Hstart, Vstart, 0, Phase

Data write : Model Name and Serial Number write in EEPROM,.

### 5.3. method & notice

- (1) Serial number D/L is using of scan equipment.
- (2) Setting of scan equipment operated by Manufacturing Technology Group.
- (3) Serial number D/L must be conformed when it is produced in production line, because serial number D/L is mandatory by D-book 4.0

# TROUBLESHOOTING

## 1. TV/CATV doesn't display

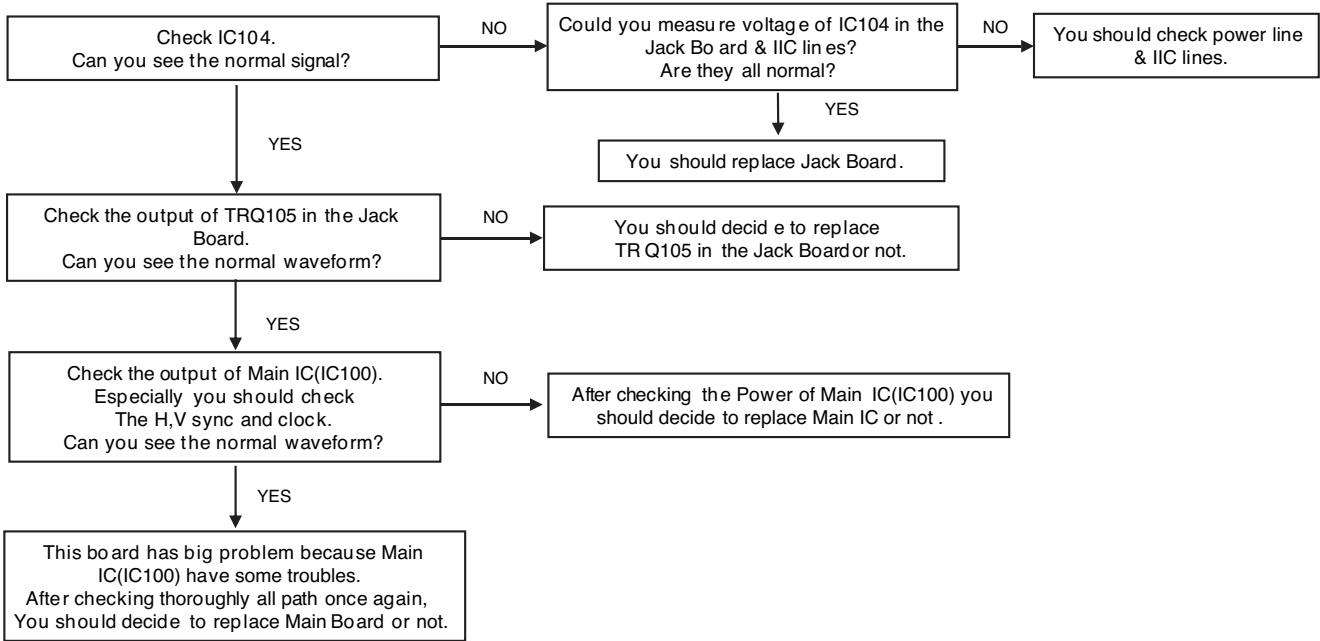

## 2. DTV doesn't display

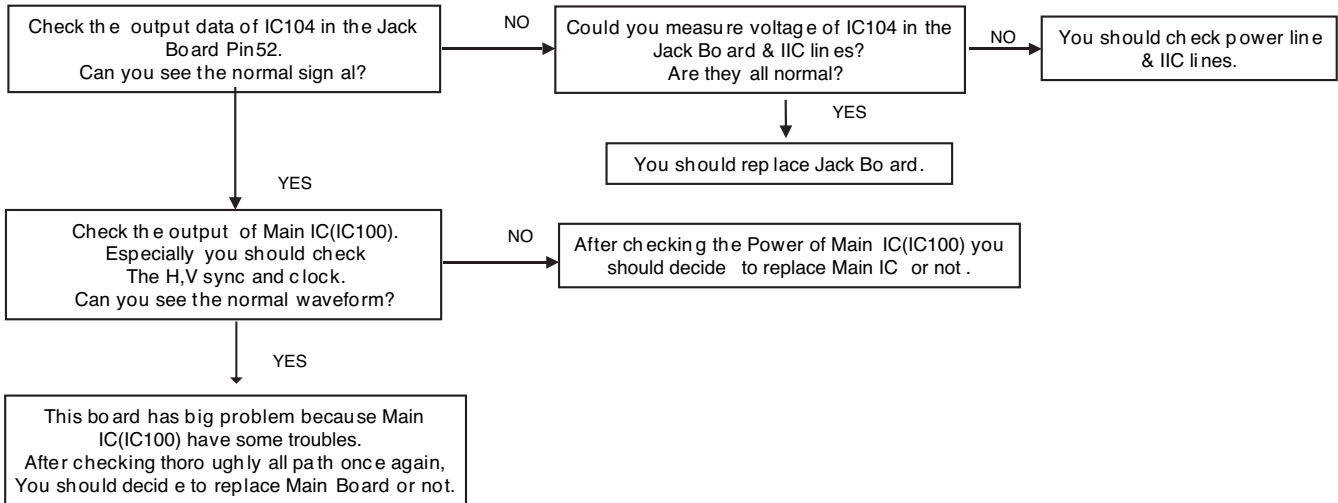

### 3. AV 1/2 doesn't display

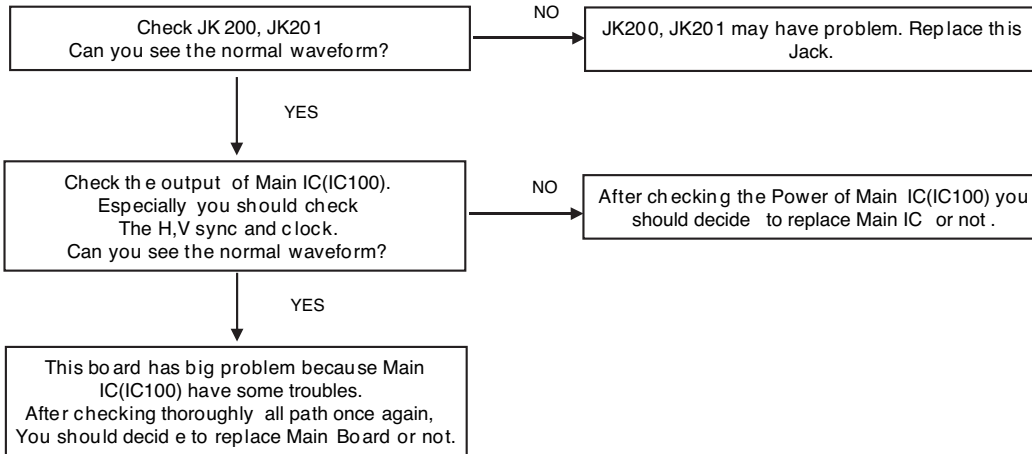

### 4. Component doesn't display

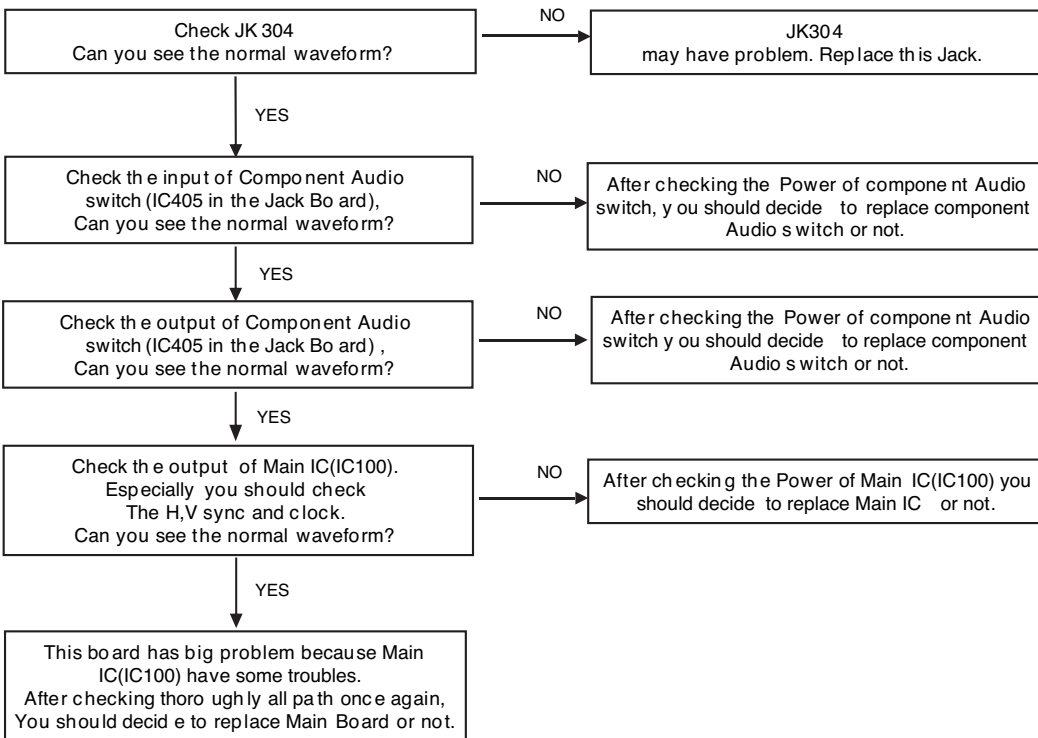



## 5. RGB PC doesn't display

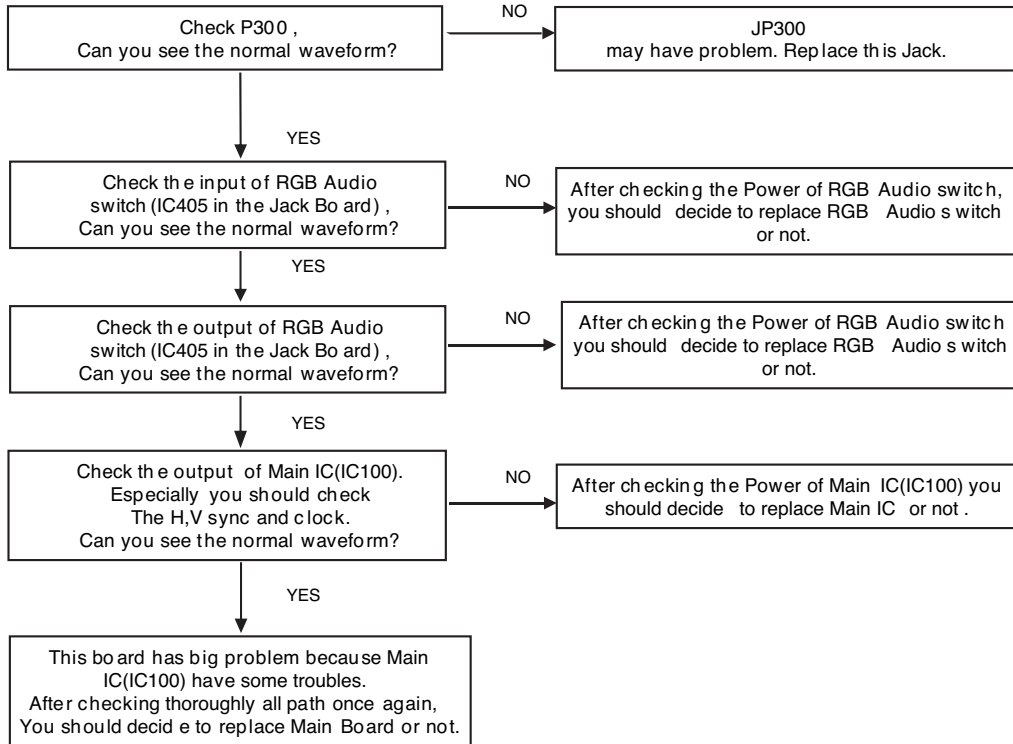

## 6. HDMI doesn't display

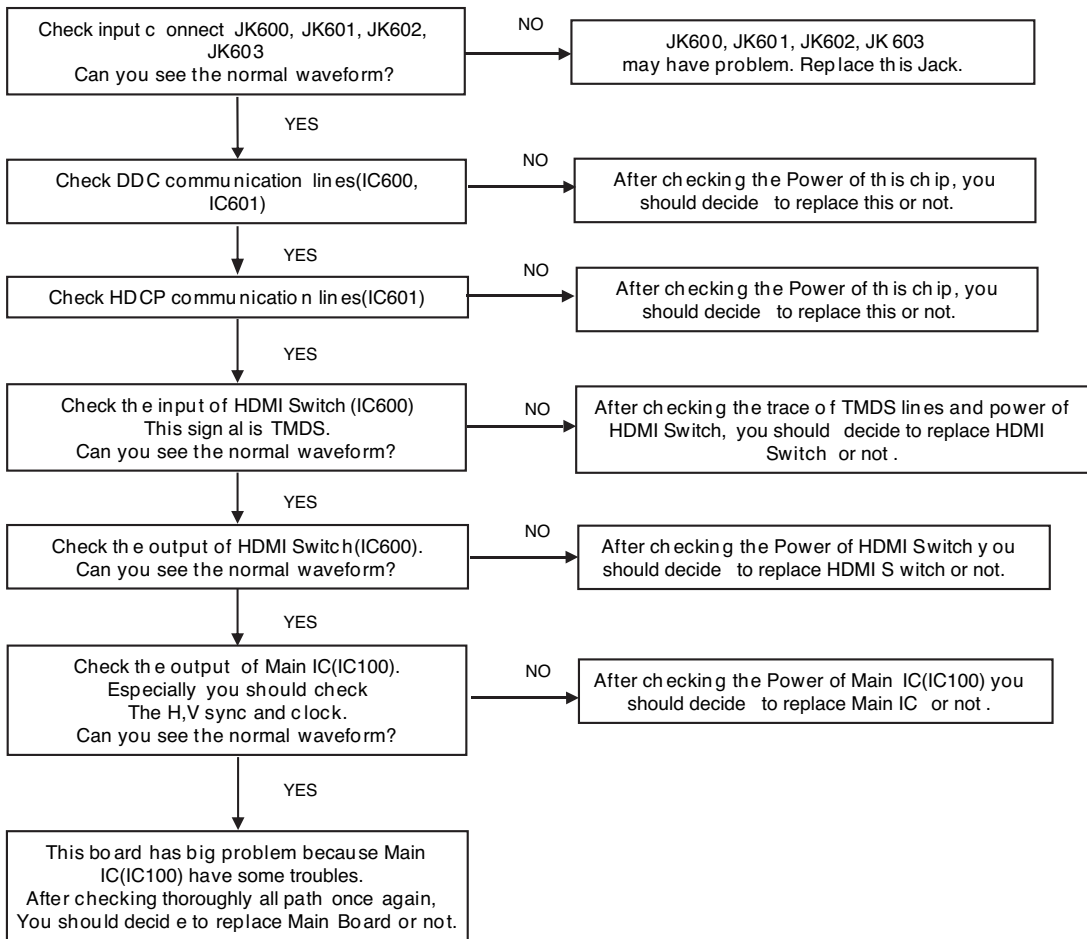



# EXPLODED VIEW

## IMPORTANT SAFETY NOTICE

Many electrical and mechanical parts in this chassis have special safety-related characteristics. These parts are identified by  $\Delta$  in the Schematic Diagram and EXPLODED VIEW. It is essential that these special safety parts should be replaced with the same components as recommended in this manual to prevent X-RADIATION, Shock, Fire, or other Hazards. Do not modify the original design without permission of manufacturer.

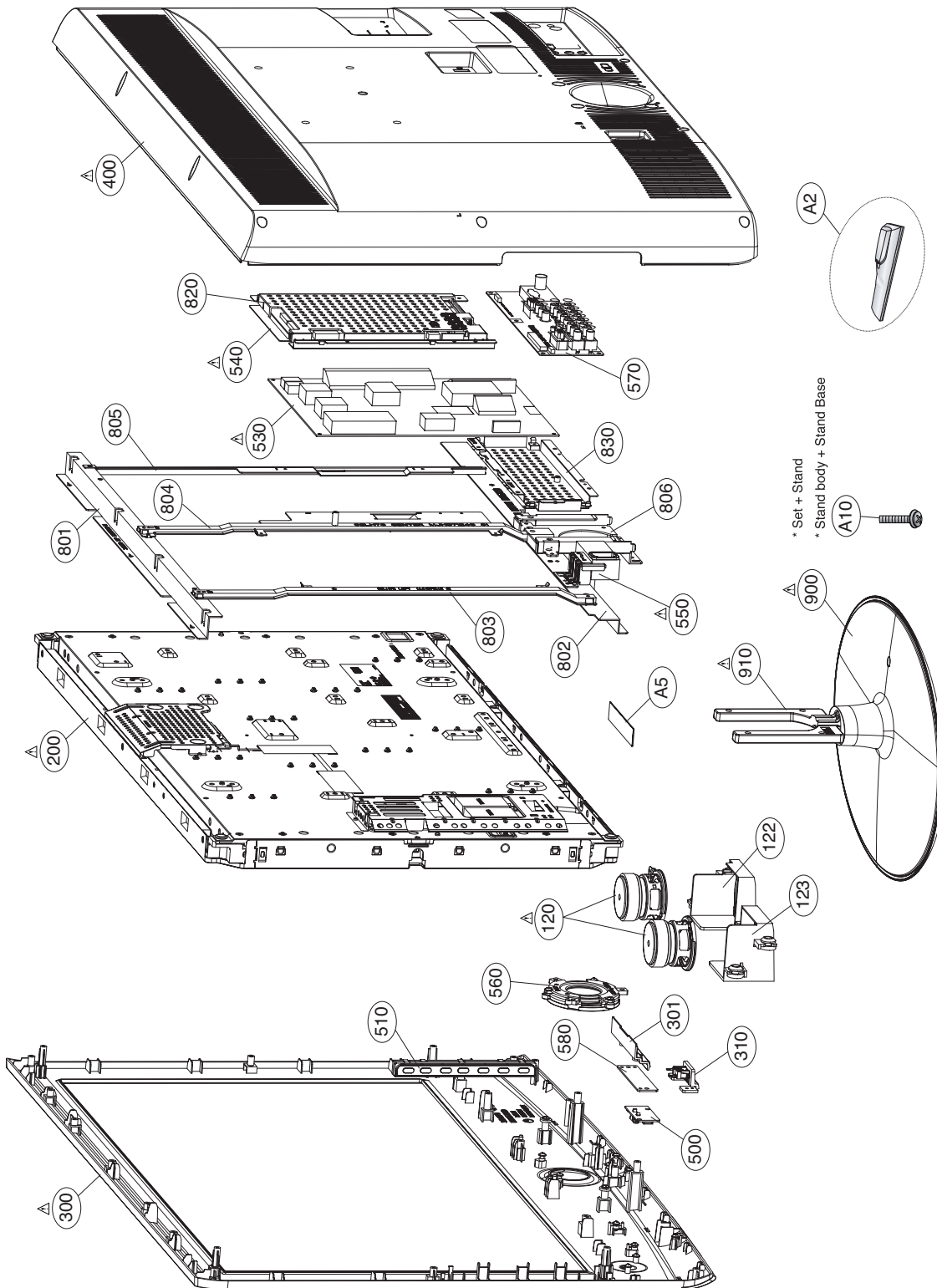

# SCHEMATIC DIAGRAM

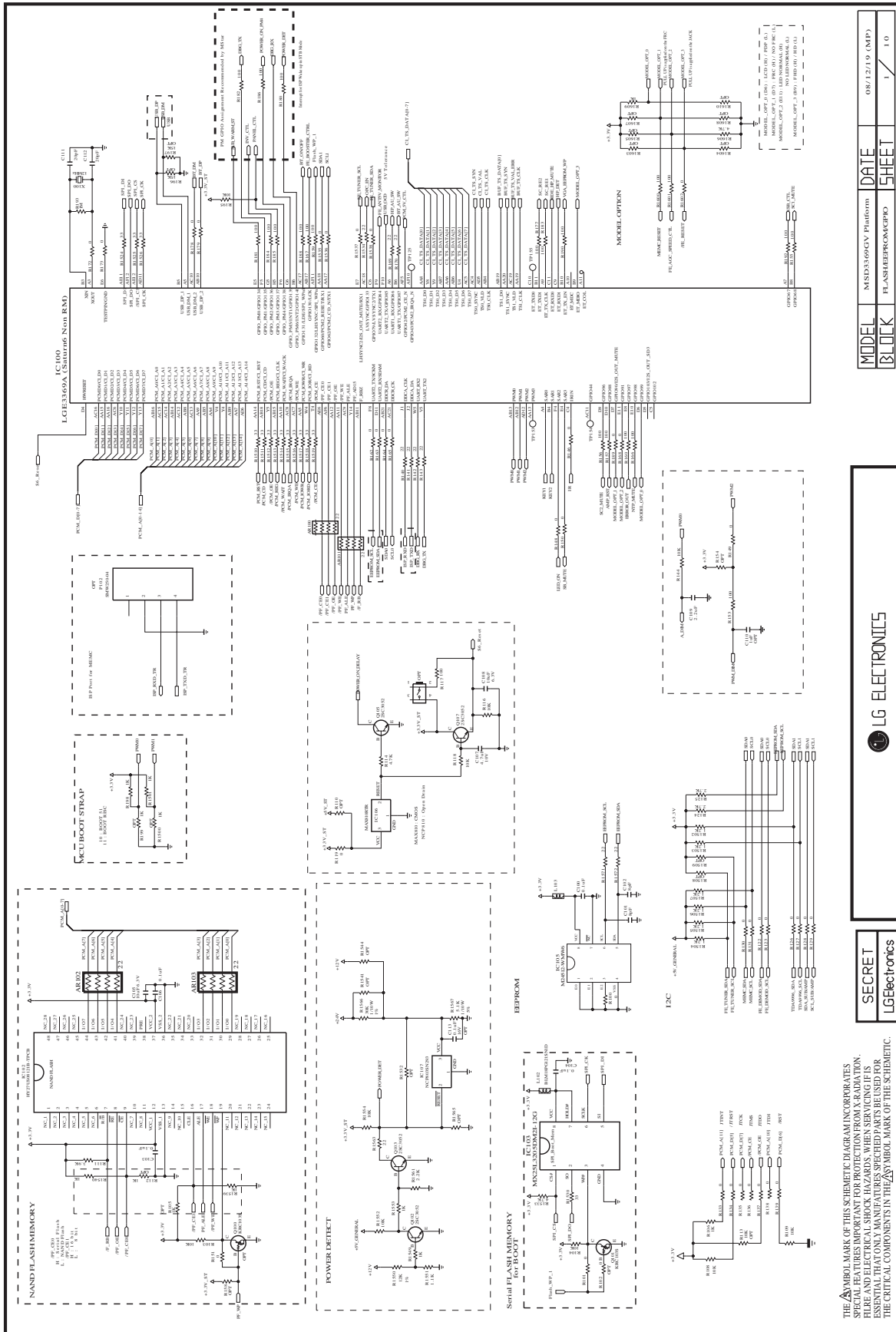

MODEL	M5SD1560GV Platform	DATE	08/12/19 (MP)
BLOCK	FLASH/DRAM/CPRO	SHEET	1 / 10

SECRET  
LGElectronics

LG ELECTRONICS

THE SYMBOL MARK OF THIS SCHEMATIC DIAGRAM INCORPORATES SPECIAL FEATURES IMPORTANT FOR PROTECTION FROM X-RADIATION, FIRE AND ELECTRICAL SHOCK HAZARDS. WHEN SERVICING IT IS ESSENTIAL THAT ONLY MANUFACTURER SPECIFIED PARTS BE USED FOR THE CRITICAL COMPONENTS IN THIS SYMBOL MARK OF THE SCHEMATIC.

EU\_SCART/EU\_HP [OPT]

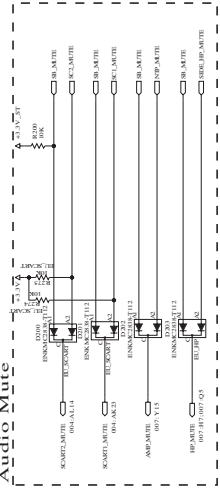

LGE3369A (Shauntic Non RM)

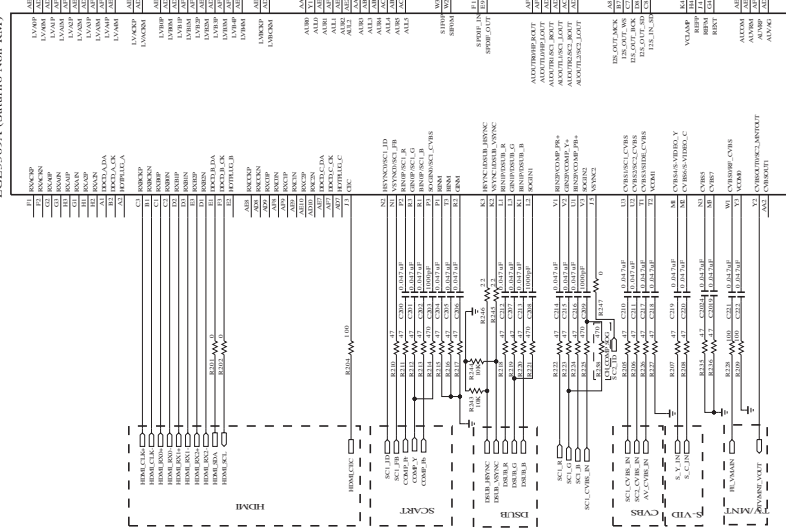

LGE3369A (Shauntic Non RM)

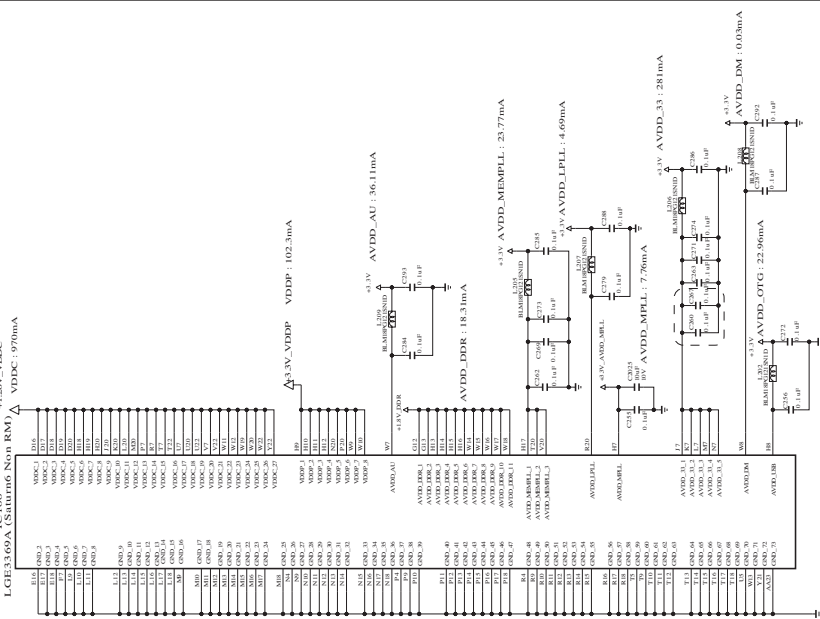

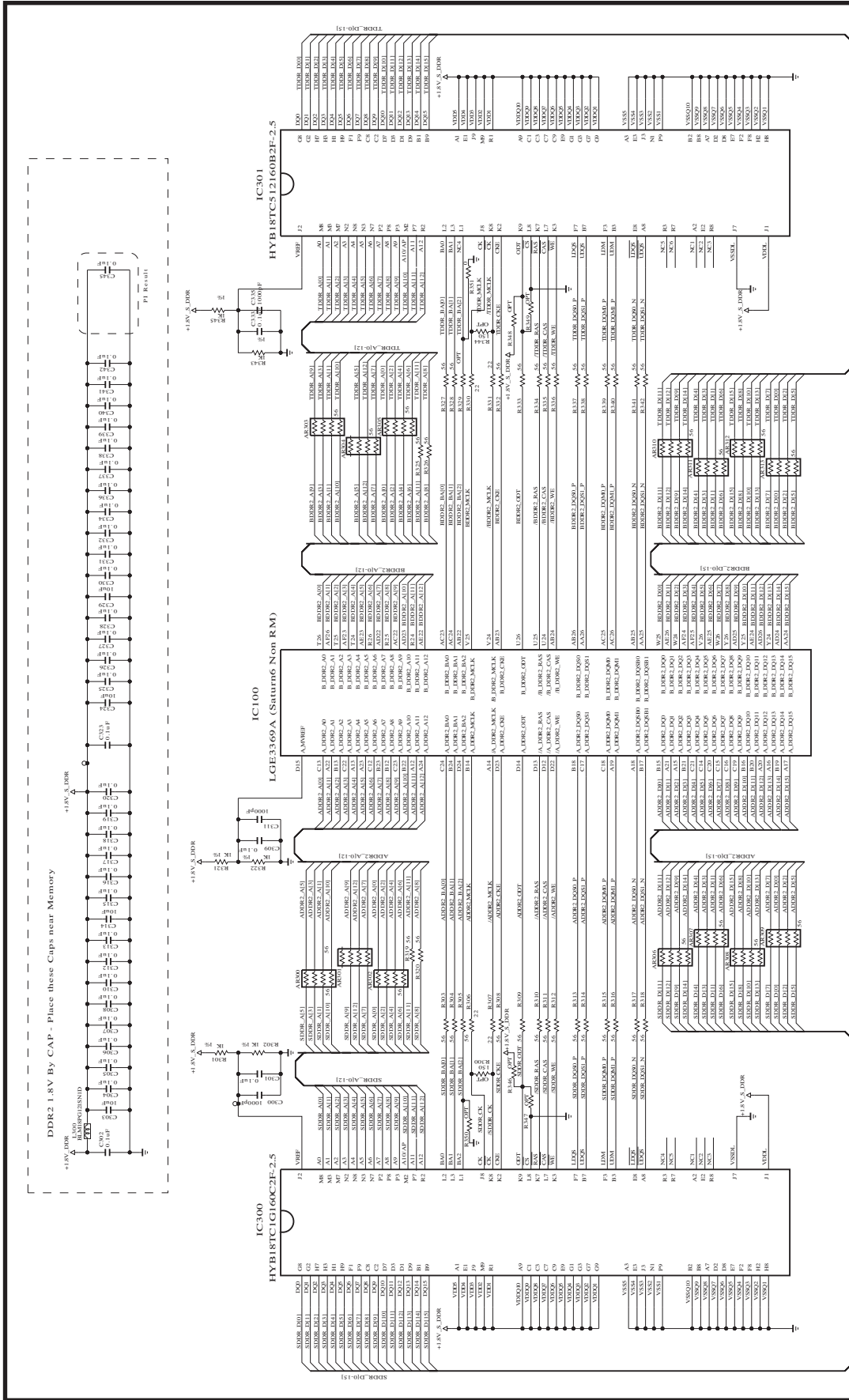

DDR2 1.8V By CAP - Place these Caps near Memory

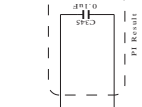

MODEL	MISD3-369CV Platform	DATE	08/12/19(MP)
BLOCK	DDR2	SHEET	3 / 10



  
**LG ELECTRONICS**

**SECRET**  
 LGElectronics

THE SYMBOL MARK OF THIS SCHEMATIC DIAGRAM INCORPORATES SPECIAL FEATURES IMPORTANT FOR PROTECTION FROM X-RADIATION, FILRE AND ELECTRICAL SHOCK HAZARDS. WHEN SERVICING IT IS ESSENTIAL THAT ONLY MANUFACTURERS SPECIFIED PARTS BE USED FOR THE CRITICAL COMPONENTS IN THE SYMBOL MARK OF THE SCHEMATIC.



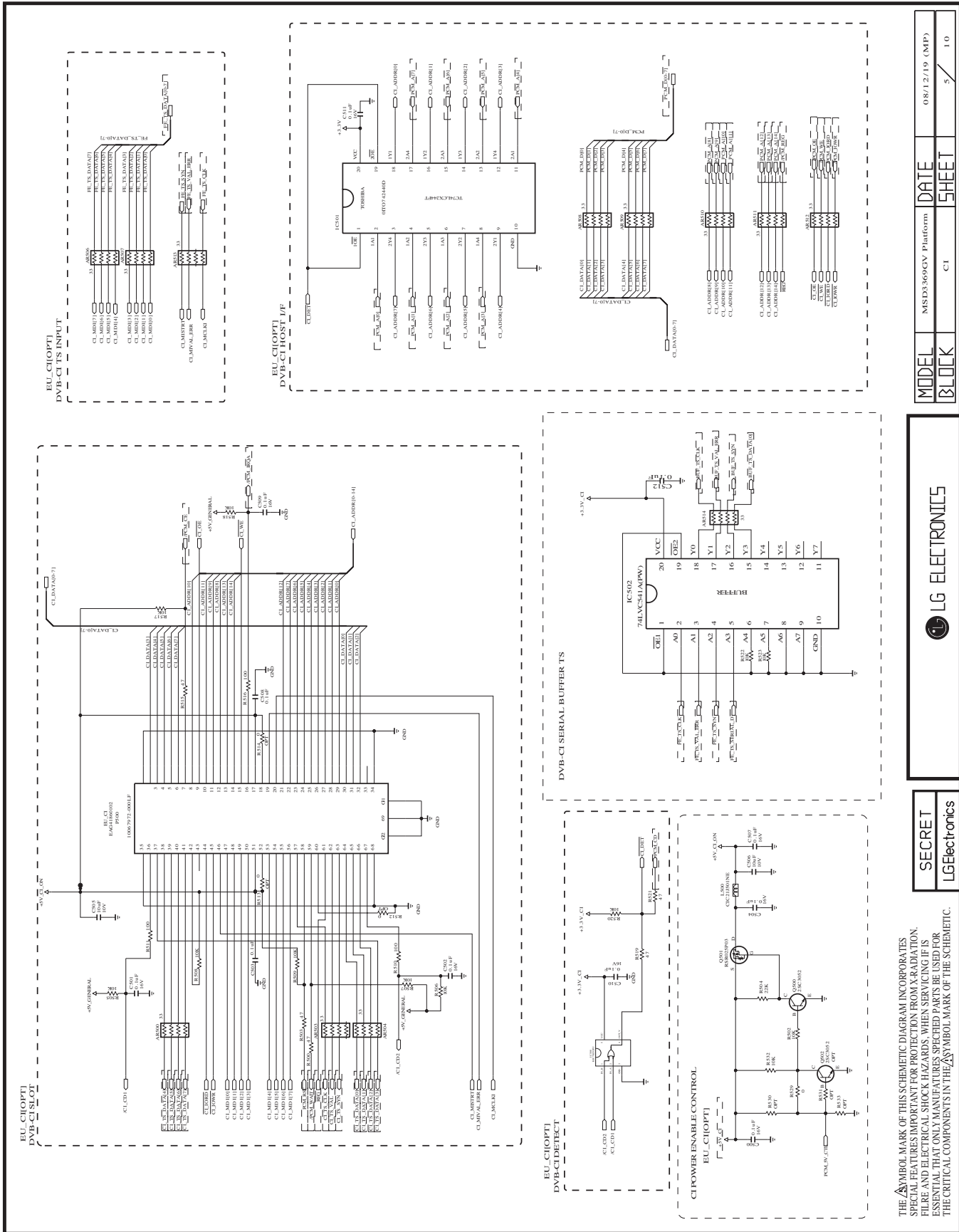



THE SYMBOL MARK OF THIS SCHEMATIC DIAGRAM INCORPORATES SPECIAL FEATURES IMPORTANT FOR PROTECTION FROM X-RADIATION, FIRE AND ELECTRICAL SHOCK HAZARDS. WHEN SERVICING IF IS ESSENTIAL THAT ONLY MANUFACTURER SPECIFIED PARTS BE USED FOR THE CRITICAL COMPONENTS IN THE SYMBOL MARK OF THE SCHEMATIC.

SECRET  
LGElectronics

LG ELECTRONICS

MODEL	M5D3369GV Platform	DATE	08/12/19 (MTP)
BLOCK	CI	SHEET	5 / 10

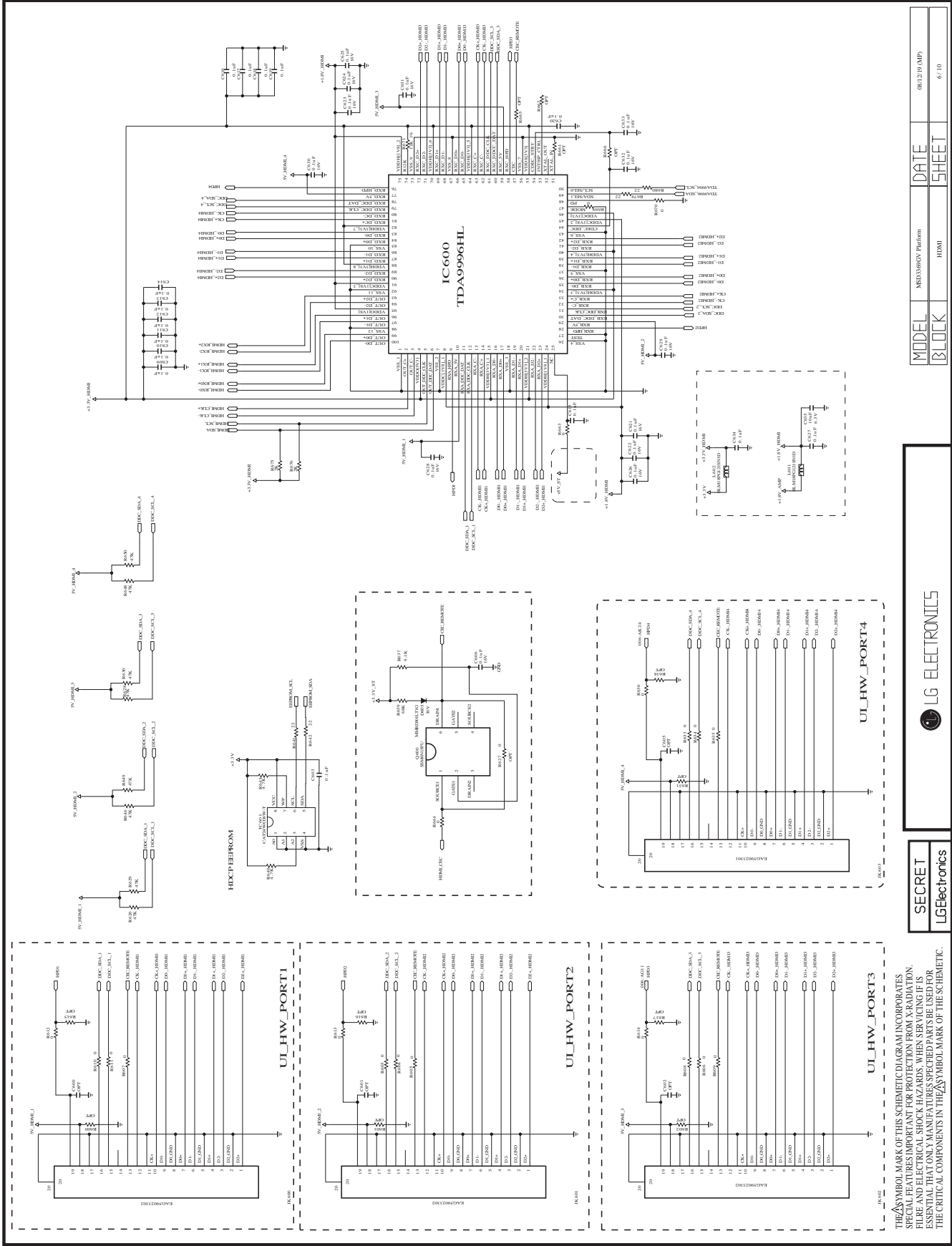

MODEL	AMS3960V Platform	DATE	081219 (IMP)
BLOCK	HDMI	SHEET	6 / 10

**SECRET**

LGElectronics

**LG ELECTRONICS**

THE SYMBOL MARK OF THIS SCHEMATIC DIAGRAM INCORPORATES SPECIAL FEATURES IMPORTANT FOR PROTECTION FROM X-RADIATION, FIRE AND ELECTRICAL SHOCK HAZARDS. WHEN SERVICING IT IS IMPORTANT TO TAKE INTO ACCOUNT THE SYMBOL MARK OF THIS SCHEMATIC. THE CRITICAL COMPONENTS IN THE SYMBOL MARK OF THIS SCHEMATIC.

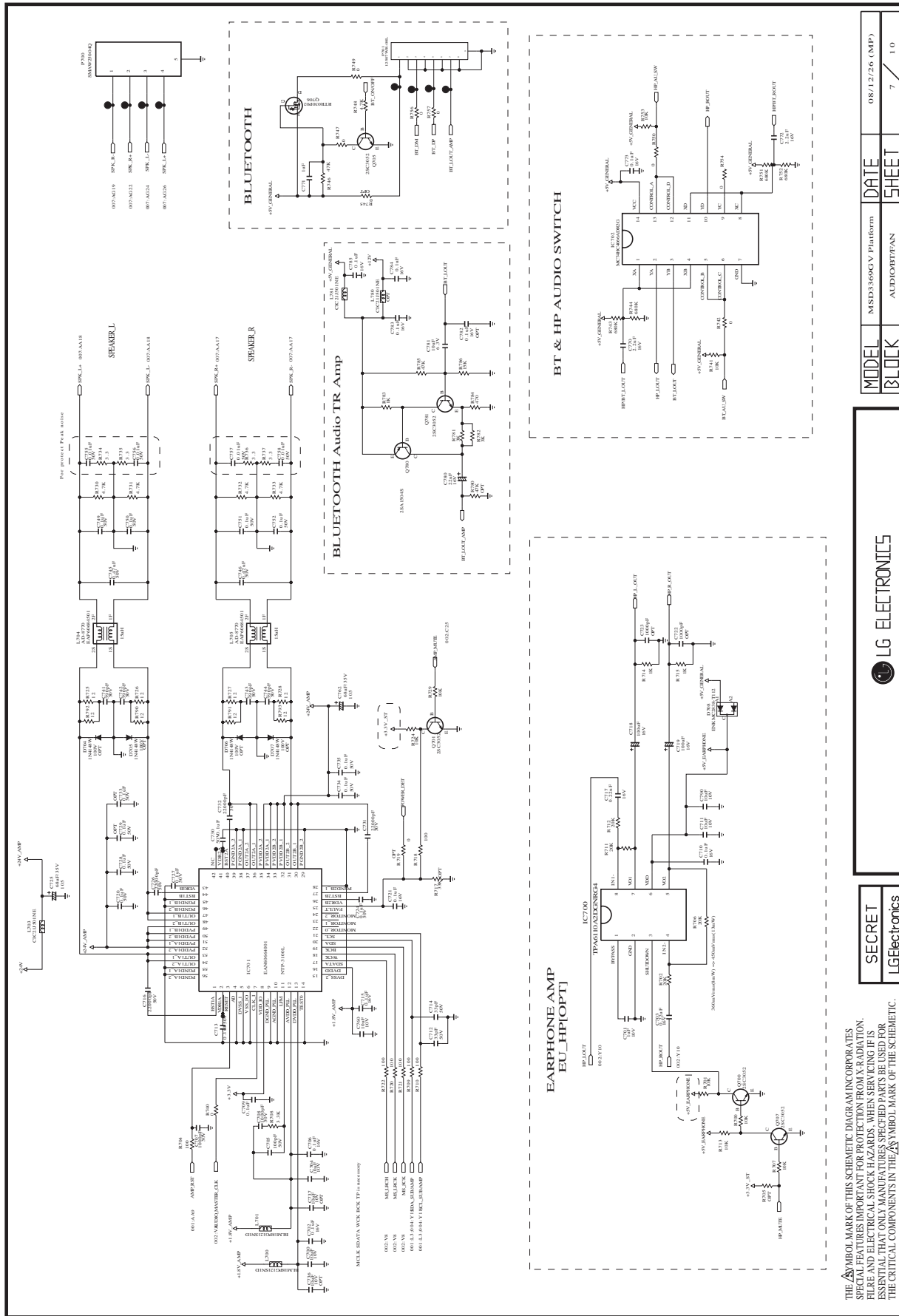

MODEL	M1SD3569GV Platform	DATE	08/12/26 (MP)
BLOCK	AUDIOBTPTAN	SHEET	7 / 10

THE SYMBOL MARK OF THIS SCHEMATIC DIAGRAM INCORPORATES SPECIAL FEATURES IMPORTANT FOR PROTECTION FROM X-RADIATION, FIRE AND ELECTRICAL SHOCK HAZARDS. WHEN SERVING IF IS ESSENTIAL THAT ONLY MANUFACTURERS SPECIFIED PARTS BE USED FOR THE CRITICAL COMPONENTS IN THE SYMBOL MARK OF THE SCHEMATIC.



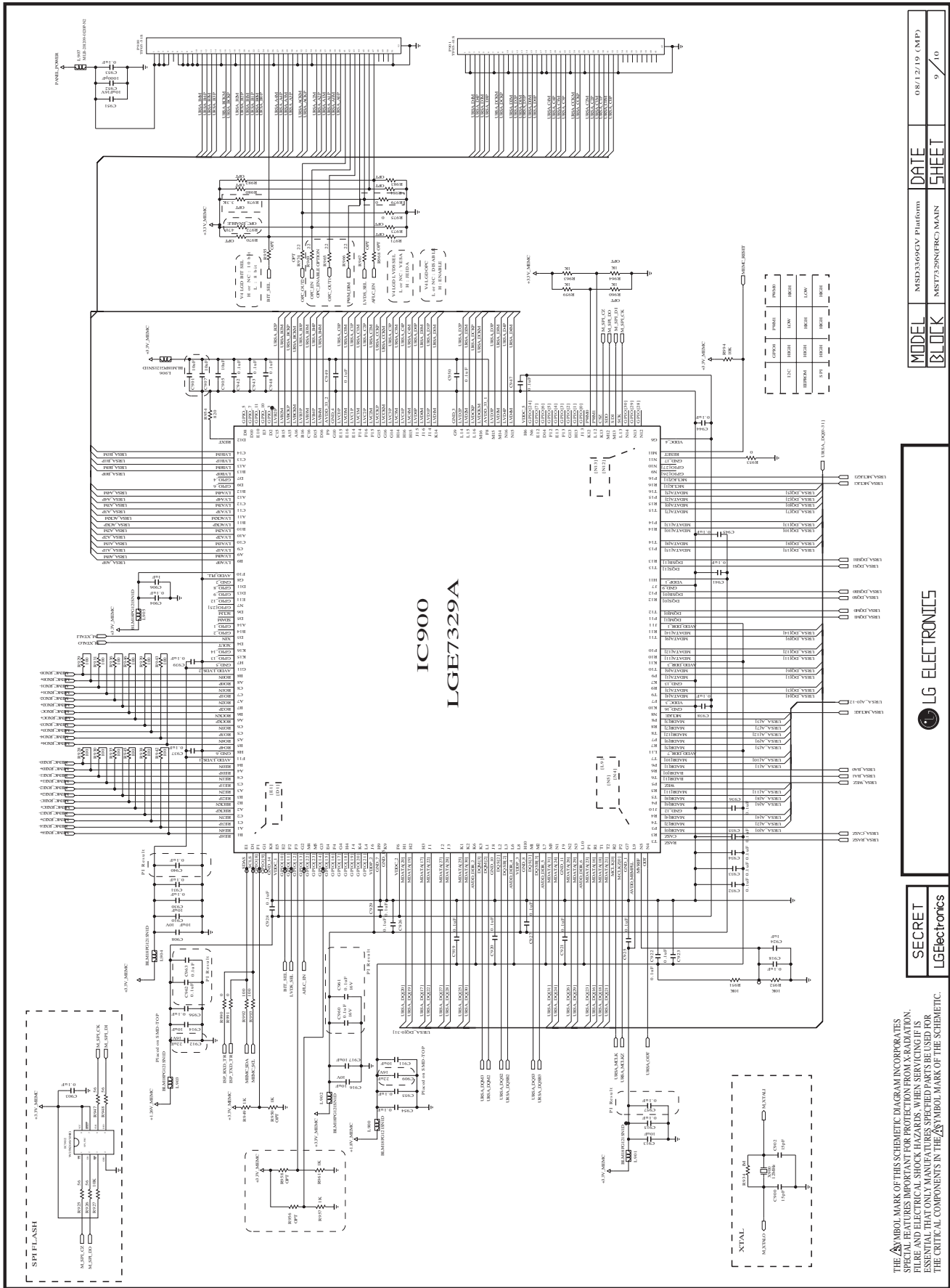

THE SYMBOL MARK OF THIS SCHEMATIC DIAGRAM INCORPORATES SPECIAL FEATURES IMPORTANT FOR PROTECTION FROM X-RADIATION, FIRE AND ELECTRICAL SHOCK HAZARDS. WHEN SERVICING IT IS ESSENTIAL THAT ONLY MANUFACTURER SPECIFIED PARTS BE USED FOR THE CRITICAL COMPONENTS IN THE SYMBOL MARK OF THE SCHEMATIC.









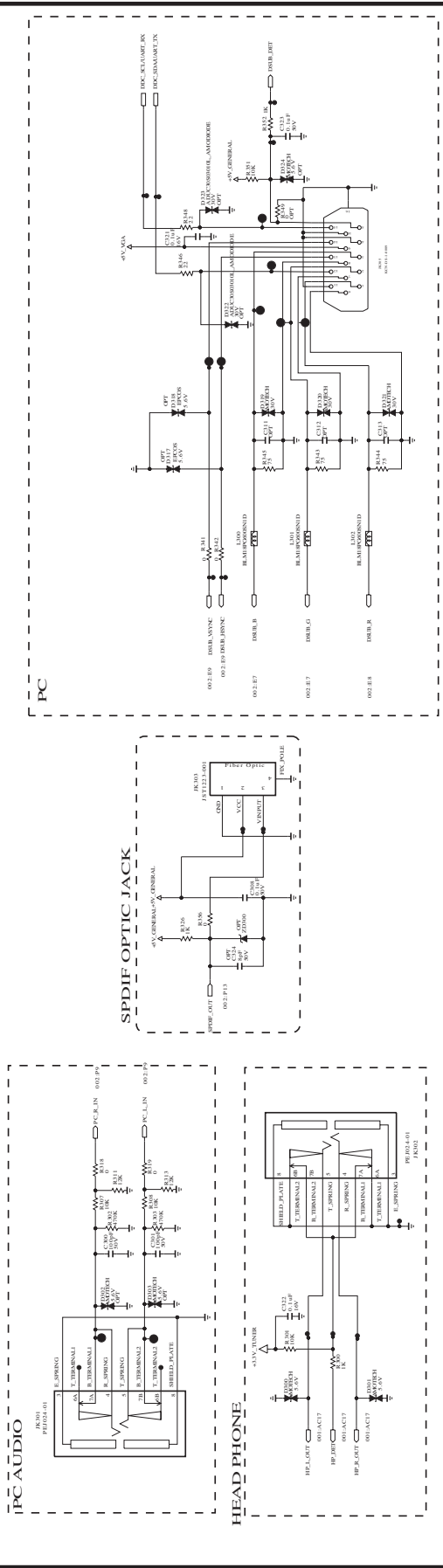
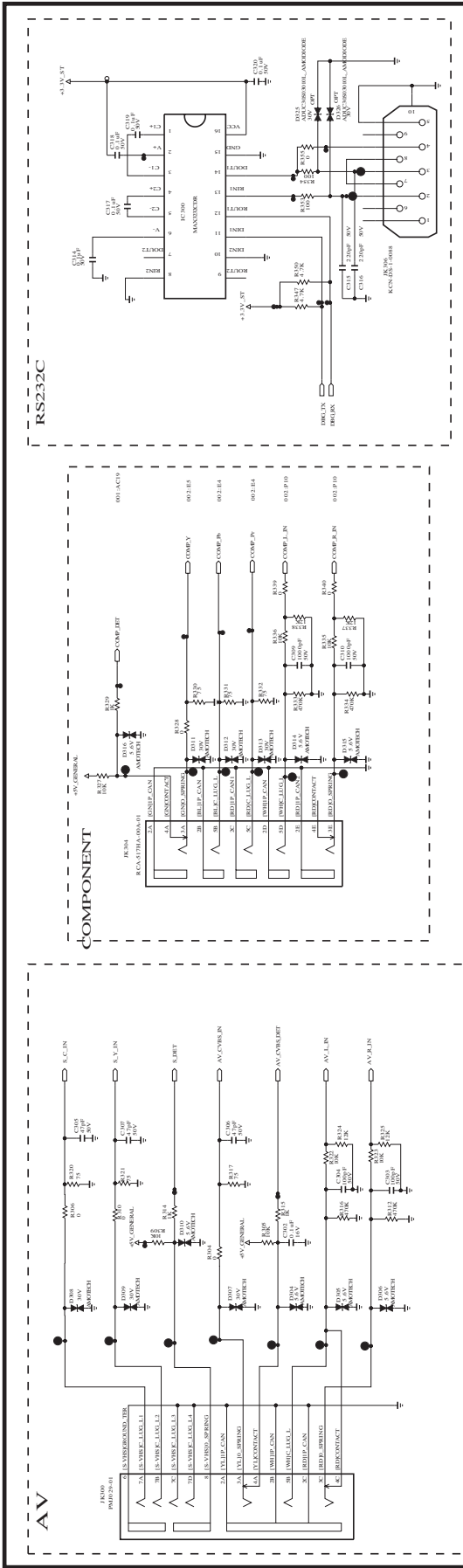

MODEL BLOCK IN/OUT

DATE SHEET

M Star

3 / 4

LG ELECTRONICS

SECRET LGElectronics

THE SYMBOL MARK OF THIS SCHEMATIC DIAGRAM INCORPORATES SPECIAL FEATURES IMPORTANT FOR PROTECTION FROM X-RADIATION, FILRE AND ELECTRICAL SHOCK HAZARDS. WHEN SERVICING IF IS ESSENTIAL THAT ONLY MANUFACTURES SPECIFIED PARTS BE USED FOR THE CRITICAL COMPONENTS IN THE SYMBOL MARK OF THE SCHEMATIC.

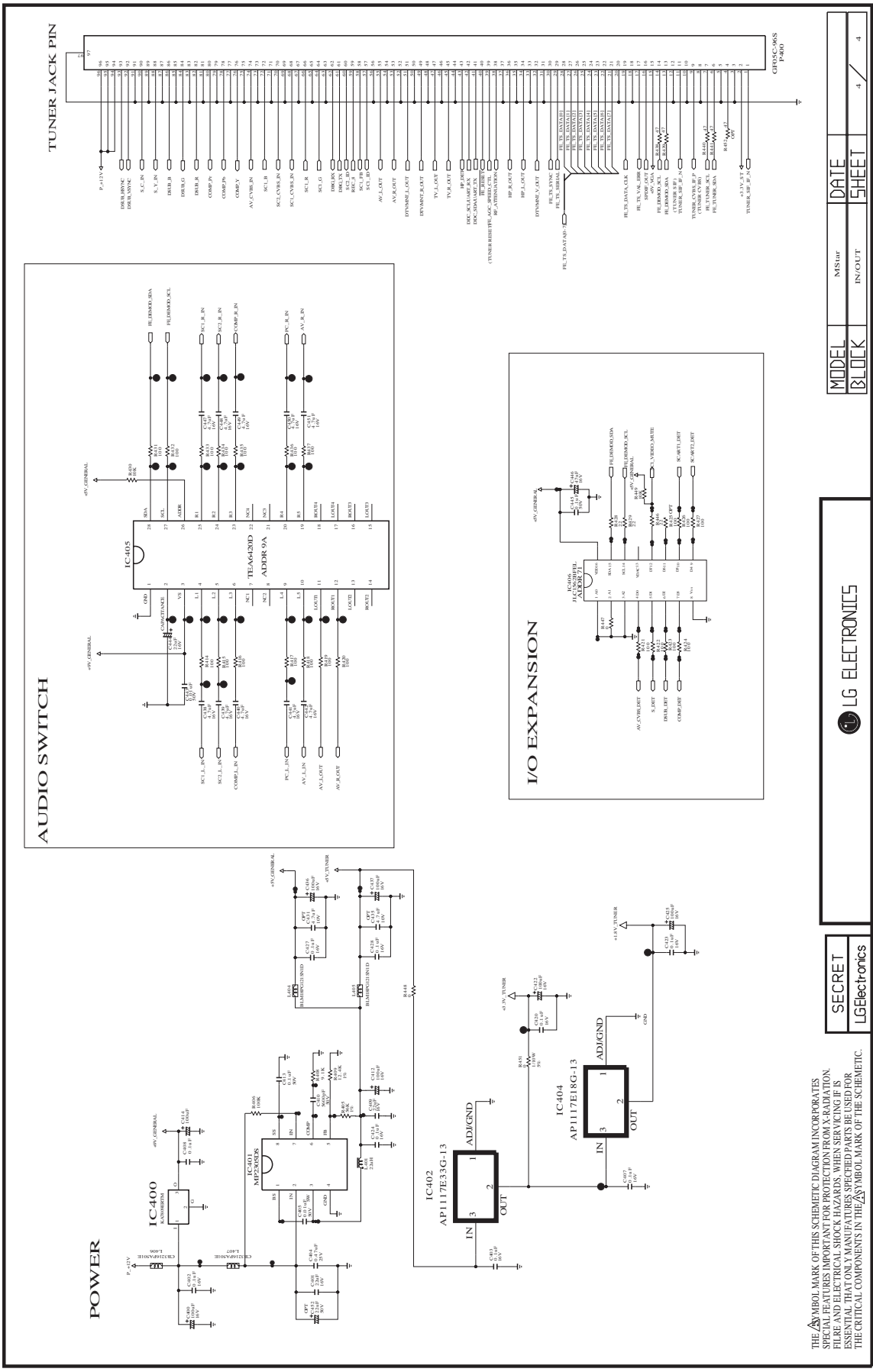

THE SYMBOL MARK OF THIS SCHEMATIC DIAGRAM INCORPORATES SPECIAL FEATURES IMPORTANT FOR PROTECTION FROM X-RADIATION, FILTRATION AND ELECTRICAL SHOCK HAZARDS. WHEN SERVICING IT IS ESSENTIAL THAT ONLY MANUFACTURER SPECIFIED PARTS BE USED FOR THE CRITICAL COMPONENTS IN THE ZENITH SYMBOL MARK OF THE SCHEMATIC.

MODEL	MS100
BLOCK	IN/OUT
DATE	
SHEET	4

**SECRET**

**LG ELECTRONICS**

**LG Electronics**



P/NO : MFL58858405

Feb., 2009  
Printed in Korea

