

---

**User's  
Manual**

**DL850/DL850V  
ScopeCorder  
Getting Started Guide**

---

# Product Registration

Thank you for purchasing YOKOGAWA products.

YOKOGAWA provides registered users with a variety of information and services.

Please allow us to serve you best by completing the product registration form accessible from our homepage.

**<http://tmi.yokogawa.com/>**

---

Thank you for purchasing the DL850 ScopeCorder or DL850V ScopeCorder Vehicle Edition (hereinafter, "DL850/DL850V" will refer to both of these products).

This getting started guide primarily explains the handling precautions and basic operations of the DL850/DL850V. To ensure correct use, please read this manual thoroughly before operation.

Keep this manual in a safe place for quick reference in the event that a question arises.

This manual is one of four DL850/DL850V manuals. Please read all manuals.

Manual Title	Manual No.	Description
DL850/DL850V ScopeCorder Features Guide	IM DL850-01EN	The supplied CD contains the PDF file of this manual. This manual explains all the DL850/DL850V features other than the communication interface features.
DL850/DL850V ScopeCorder User's Manual	IM DL850-02EN	The supplied CD contains the PDF file of this manual. The manual explains how to operate the DL850/DL850V.
DL850/DL850V ScopeCorder Getting Started Guide	IM DL850-03EN	This manual. This guide explains the handling precautions and basic operations of the DL850/DL850V.
DL850/DL850V ScopeCorder Communication Interface User's Manual	IM DL850-17EN	The supplied CD contains the PDF file of this manual. The manual explains the DL850/DL850V communication interface features and instructions on how to use them.

## Notes

- The contents of this manual are subject to change without prior notice as a result of continuing improvements to the instrument's performance and functions. The figures given in this manual may differ from those that actually appear on your screen.
- Every effort has been made in the preparation of this manual to ensure the accuracy of its contents. However, should you have any questions or find any errors, please contact your nearest YOKOGAWA dealer.
- Copying or reproducing all or any part of the contents of this manual without the permission of Yokogawa Electric Corporation is strictly prohibited.
- The TCP/IP software of this product and the documents concerning it have been developed/created by YOKOGAWA based on the BSD Networking Software, Release 1 that has been licensed from the Regents of the University of California.

## Trademark Acknowledgements

- Microsoft, Internet Explorer, MS-DOS, Windows, Windows NT, and Windows XP are either registered trademarks or trademarks of Microsoft Corporation in the United States and/or other countries.
- Adobe, Acrobat, and PostScript are trademarks of Adobe Systems Incorporated.
- PIEZOTRON is a registered Trademark of Kistler Instrumente AG.
- PCB and ICP are registered trademarks of PCB Group, Inc.
- Isotron is a registered trademark of Meggitt Group, PLC.
- VJE is a registered trademark of Yahoo Japan Corporation.
- GIGAZoom ENGINE is a registered trademark of YOKOGAWA Electric Corporation.
- In this manual, the TM and ® symbols do not accompany their respective registered trademark or trademark names.
- Other company and product names are trademarks or registered trademarks of their respective companies.

## Revisions

- 1st Edition: June 2010
- 2nd Edition: September 2010

# Checking the Contents of the Package

Unpack the box, and check the contents before operating the instrument. If the wrong items have been delivered, if items are missing, or if there is a problem with the appearance of the items, contact your nearest YOKOGAWA dealer.

## DL850/DL850V

Check that the product that you received is what you ordered by referring to the model name and suffix code given on the name plate on the left side panel.

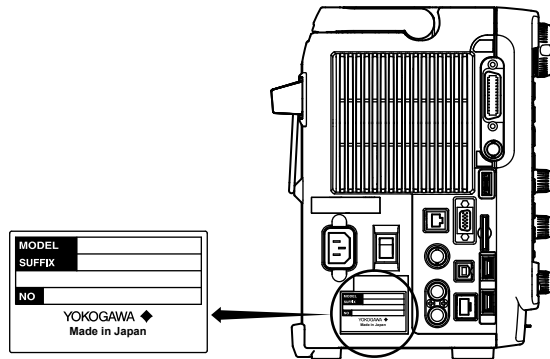

MODEL	Suffix Code	Description
DL850/DL850V		Main device, 8 slots, 250 Mpoint memory
Power cord	-D	UL/CSA Standard power cord (Part No.: A1006WD) [Maximum rated voltage: 125 V]
	-F	VDE Standard Power Cord (Part No.: A1009WD) [Maximum rated voltage: 250 V]
	-Q	BS Standard Power Cord (Part No.: A1054WD) [Maximum rated voltage: 250 V]
	-R	AS Standard Power Cord (Part No.: A1024WD) [Maximum rated voltage: 250 V]
	-H	GB Standard Power Cord (Part No.: A1064WD) [Maximum rated voltage: 250 V]
Language	-HJ	Japanese
	-HE	English
	-HC	Chinese
	-HK	Korean
	-HG	German
	-HF	French
	-HL	Italian
	-HS	Spanish
Options	/B5	Built-in printer <sup>1</sup>
	/M1	Memory expansion to 1 Gpoint <sup>2</sup>
	/M2	Memory expansion to 2 Gpoint <sup>2</sup>
	/HD0	External HDD interface <sup>3</sup>
	/HD1	160 GB internal HDD <sup>3</sup>
	/C1	GP-IB interface <sup>4</sup>
	/C20	GP-IB interface + IRIG <sup>4</sup>
	/G2	User-defined computation
	/P4	Probe power supply, four outputs

- 1 Includes one roll of paper (B9988AE)
- 2 The /M1 and /M2 options cannot be installed on the same instrument.
- 3 The /HD0 and /HD1 options cannot be installed on the same instrument.
- 4 The /C1 and /C20 options cannot be installed on the same instrument.

## No. (Instrument Number)

When contacting the dealer from which you purchased the instrument, please give them the instrument number.



## Standard Accessories

The standard accessories below are supplied with the instrument. Check that all contents are present and undamaged.

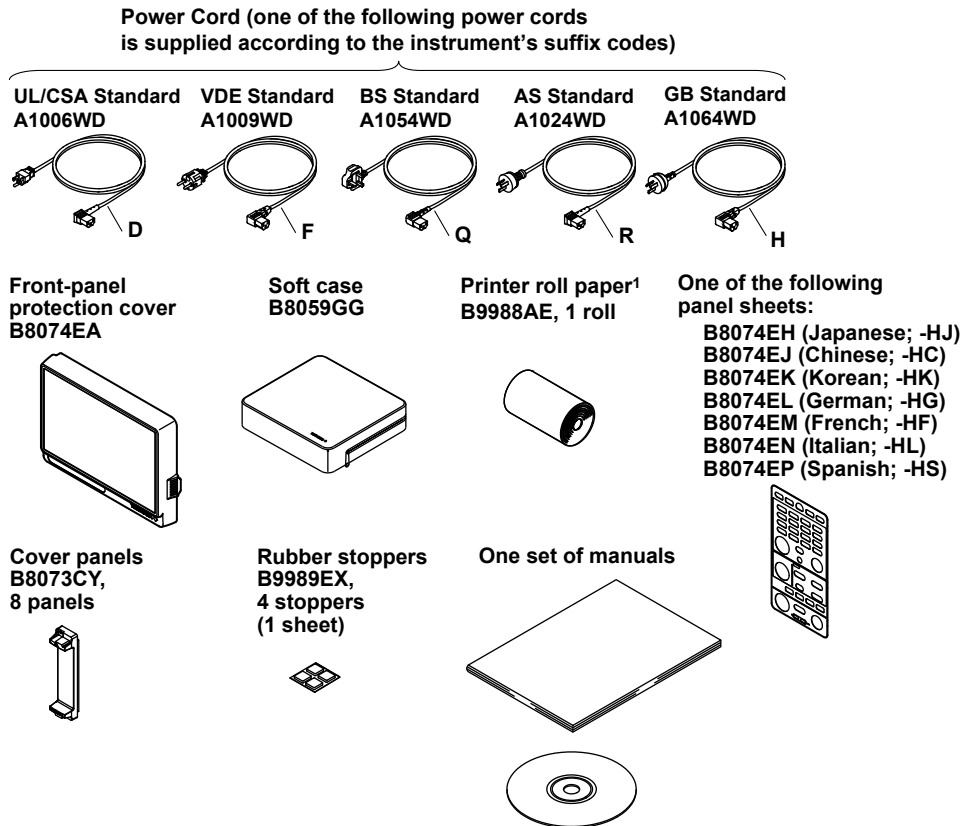

<sup>1</sup> Only included with models that have a built-in printer (/B5)

## How to Use the CD-ROM (User's Manuals)

The CD-ROM contains PDF files of the following manuals.

- DL850/DL850V ScopeCorder Features Guide  
IM DL850-01EN
- DL850/DL850V ScopeCorder User's Manual  
IM DL850-02EN
- DL850/DL850V ScopeCorder Communication Interface User's Manual  
IM DL850-17EN

To view the above manuals, you need Adobe Reader 5.0 or later.

### WARNING

Never play this CD-ROM on an audio CD player. Doing so may cause loss of hearing or speaker damage due to the large sounds that may be produced.

## Input Modules (Sold Separately)

To make sure that an input module is the module that you ordered, check the module name written on it.

MODEL	Name	Abbreviation
701250	High-Speed 10 MS/s, 12-Bit Isolation Module	HS10M12
701251	High-Speed High-Resolution 1 MS/s, 16-Bit Isolation Module	HS1M16
701255	High-Speed 10 MS/s, 12-Bit Non-Isolation Module	NONISO_10M12
701260	High-Voltage 100 kS/s, 16-Bit Isolation Module (with RMS)	HV (with RMS)
701261	Universal (Voltage/Temp.) Module	UNIVERSAL
701262	Universal (Voltage/Temp.) Module (with AAF)	UNIVERSAL(AAF)
701265	Temperature, High Precision Voltage Isolation Module	TEMP/HPV
701270	Strain Module (NDIS)	STRAIN_NDIS
701271	Strain Module (DSUB, Shunt-Cal)	STRAIN_DSUB
701275	Acceleration/Voltage Module (with AAF)	ACCL/VOLT
701280	Frequency Module	FREQ
720210	High-Speed 100 MS/s, 12-Bit Isolation Module	HS100M12
720220	16-CH Voltage Input Module	16CH VOLT
720230	Logic Input Module	LOGIC
720240	CAN Bus Monitor Module*	CAN MONITOR

\* The CAN bus monitor module can be used on the DL850V. It cannot be used on the DL850.

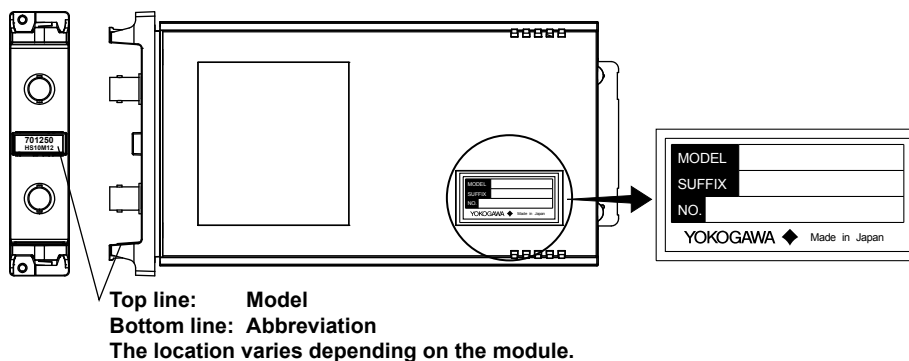

In this manual, input modules are referred to by their model names and abbreviations. For example, the High-Speed 10 MS/s, 12-Bit Isolation Module is referred to as the 701250 (HS10M12). However, if a module has already been referred to previously, it may be referred to only by its model name (for example, 701250).

### Note

To use the DL850/DL850V with 701250 and 701255 modules shipped between August 2006 and June 2007, you must update the module firmware. If error code 916 appears when you turn on the DL850/DL850V, it may be necessary to update the firmware of the aforementioned modules. Prepare the module serial numbers, and contact your nearest YOKOGAWA dealer. The dealer will update the module firmware for a fee.

## Optional Accessories (Sold Separately)

The optional accessories below are available for purchase separately. Check that all contents are present and undamaged. For information about ordering accessories, contact your nearest YOKOGAWA dealer.

Name	Model	Safety standard <sup>1</sup>	Note
Isolated probe	700929	1000 Vrms CAT II	10:1 safety probe for the 701250, 701251, 701260, and 720210
	701947	1000 Vrms CAT II	100:1 safety probe for the 701250, 701251, 701260, and 720210
Current probe	701933	300 Vrms CAT I	30 Arms, DC to 50 MHz. Used by connecting to a probe power terminal (/P4 option) or a probe power supply (701934; sold separately).
	701930	300 Vrms CAT III	150 Arms, DC to 10 MHz. Used by connecting to a probe power terminal (/P4 option) or a probe power supply (701934; sold separately).
	701931	300 Vrms CAT III	500 Arms, DC to 2 MHz. Used by connecting to a probe power terminal (/P4 option) or a probe power supply (701934; sold separately).
Differential probe	700924	1000 Vrms CAT III <sup>2</sup>	Switchable between 1000:1 and 100:1 Measurable voltage: 1400 V <sub>peak</sub> (1000 Vrms)
10:1 passive probe	701940	—	For non-isolated input on the 701255: 600 V or less For isolated input other than above: 42 V or less
1:1 BNC safety adapter lead	701901	1000 Vrms CAT II	For use with the 701250, 701251, 701260, and 720210. Used with the following items (which are sold separately): the 701954, 701959, 758922, 758929, or 758921.
Alligator clip (dolphin type)	701954	1000 Vrms CAT III	Two pieces in one set (red/black)
Safety mini-clip (hook type)	701959	1000 Vrms CAT II	Two pieces in one set (red/black)
Alligator clip adapter	758922	300 Vrms CAT II	Two pieces in one set
Alligator clip adapter	758929	1000 Vrms CAT II	Two pieces in one set
Fork terminal adapter	758921	1000 Vrms CAT II	Two pieces in one set (red/black). For 4 mm screws.
Cable <sup>3</sup>	366926	—	For measuring low voltage of less than or equal to 42 V
Banana-alligator clip cable	366961	—	For measuring low voltage of less than or equal to 42 V for the 701261, 701262, or 701265
High-speed logic probe	700986	—	42 V or less, 8 bits, non-isolated, response speed of 1 μs
Isolated logic probe	700987	250 Vrms CAT II	8 bits, each channel isolated, response speed of 20 ms (for AC)
1 m logic probe	702911	8 bits, non-isolated	—
3 m logic probe	702912	8 bits, non-isolated	—
Isolated logic measuring lead	758917	1000 Vrms CAT II	Two pieces in one set. Used with the 758922 or 758929 adapter. The adapters are sold separately.
External I/O cable	720911	—	For external I/O
1 m safety BNC cable	701902	1000 Vrms CAT II	—
2 m safety BNC cable	701903	1000 Vrms CAT II	—
Safety BNC-to-banana adapter	758924	500 Vrms CAT II	For the 701250, 701251, 701255, 701260, and 720210
Probe power supply	701934	—	High current output power supply for external probes (four outputs)
Shunt resistor	438920	—	250 Ω ± 0.1%
	438921	—	100 Ω ± 0.1%
	438922	—	10 Ω ± 0.1%
Bridgehead	701955	—	NDIS, bridge resistance: 120 Ω
	701956	—	NDIS, bridge resistance: 350 Ω
	701957	—	DSUB, bridge resistance: 120 Ω, shunt-cal support
	701958	—	DSUB, bridge resistance: 350 Ω, shunt-cal support
Soft carrying case	701963	—	Has three pockets

Sold individually.

- 1 The actual voltage that can be used is the lowest voltage of the DL850/DL850V and cable specifications.
- 2 Be sure to connect the GND lead provided with the 700924 to the functional ground terminal of the DL850/DL850V. The connection of the GND lead makes 1400 V<sub>peak</sub> measurement possible.
- 3 Use cables (366926) that YOKOGAWA has been shipping since February 4, 1998. Cables (366926) shipped before this date cannot be used in combination with the DL850/DL850V input modules.

## Checking the Contents of the Package

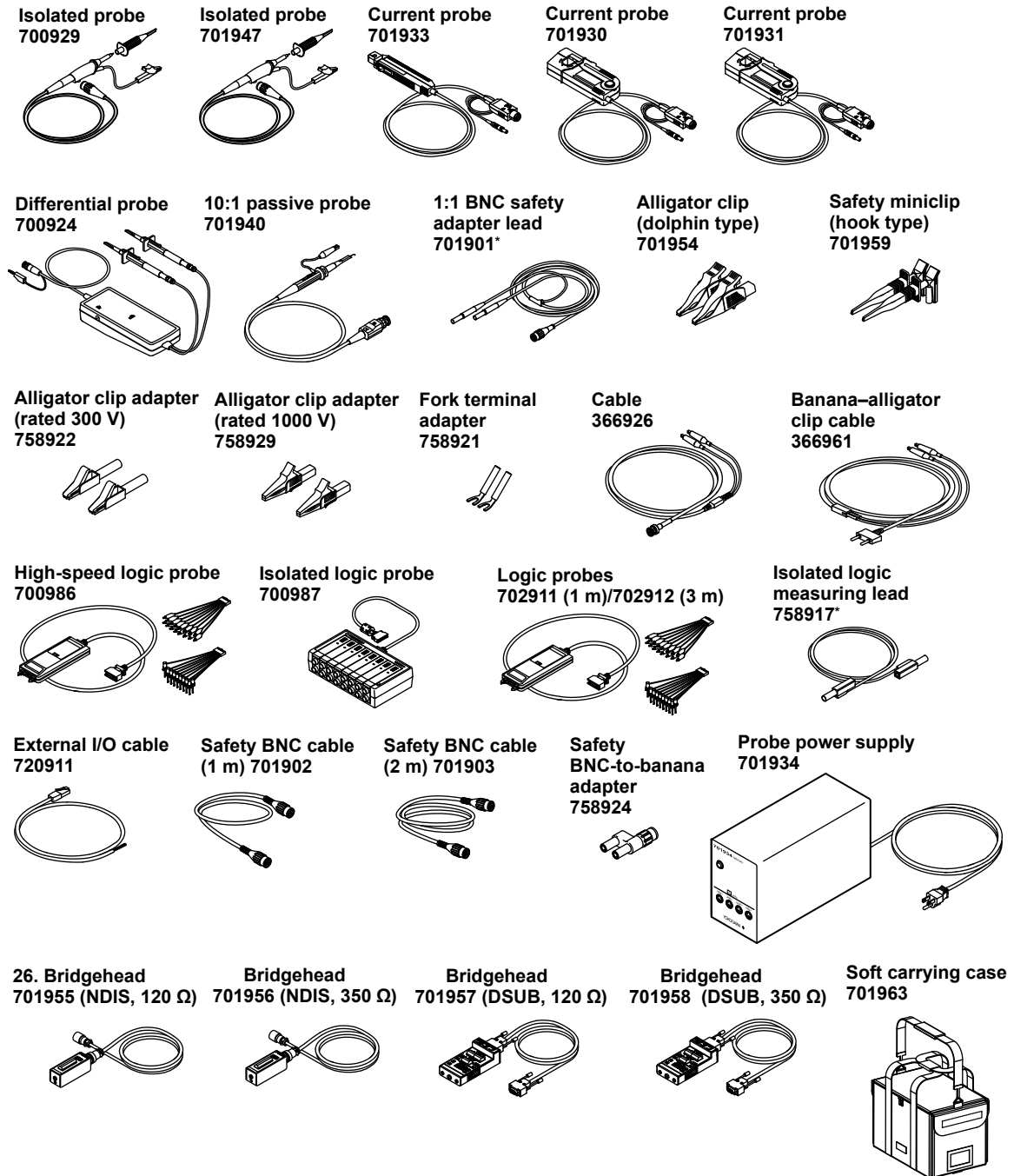

\* The 1:1 BNC safety adapter lead (701901) must be used with one of the following accessories (which are sold separately): alligator clip (dolphin type: 701954), safety miniclip (hook type: 701959), alligator adapter (758922 or 758929), or fork terminal adapter (758921).

## Spare Parts (Sold Separately)

The spare parts below are available for purchase separately. Check that all contents are present and undamaged.

For information about ordering spare parts, contact your nearest YOKOGAWA dealer.

Name	Part No.	Minimum Q'ty	Note
Printer roll paper	B9988AE	10	Thermo-sensitive paper, 111 mm × 10 m
Terminal block	A1800JD	1	For the 720220 input module

---

# Safety Precautions

This instrument is an IEC safety class I instrument (provided with a terminal for protective earth grounding).

The general safety precautions described herein must be observed during all phases of operation. If the instrument is used in a manner not specified in this manual, the protection provided by the instrument may be impaired. Yokogawa Electric Corporation assumes no liability for the customer's failure to comply with these requirements.

## The Following Symbols Are Used on This Instrument.



Warning: handle with care. Refer to the user's manual or service manual. This symbol appears on dangerous locations on the instrument which require special instructions for proper handling or use. The same symbol appears in the corresponding place in the manual to identify those instructions.



Protective ground terminal



Ground or the functional ground terminal (do not use as the protective earth ground terminal)



Alternating current



ON (power)



OFF (power)

**Make sure to comply with the precautions below. Not complying might result in injury or death.**

---

**WARNING**

**Use the Correct Power Supply**

Before connecting the power cord, ensure that the source voltage matches the rated supply voltage of the DL850/DL850V and that it is within the maximum rated voltage of the provided power cord.

**Use the Correct Power Cord and Plug**

To prevent the possibility of electric shock or fire, be sure to use the power cord supplied by YOKOGAWA. The main power plug must be plugged into an outlet with a protective earth terminal. Do not invalidate this protection by using an extension cord without protective earth grounding.

Also, do not use the power cord that came with the instrument on any other device.

**Connect the Protective Grounding Terminal**

Make sure to connect the protective earth to prevent electric shock before turning ON the power. The power cord that comes with the instrument is a three-pin type power cord. Connect the power cord to a properly grounded three-pin outlet.

**Do Not Impair the Protective Grounding**

Never cut off the internal or external protective earth wire or disconnect the wiring of the protective earth terminal. Doing so poses a potential shock hazard.

**Do Not Operate with Defective Protective Grounding or Fuse**

Do not operate the instrument if the protective earth or fuse might be defective. Make sure to check them before operation.

**Do Not Operate in an Explosive Atmosphere**

Do not operate the instrument in the presence of flammable liquids or vapors. Operation in such an environment constitutes a safety hazard.

**Do Not Remove Covers**

The cover should be removed by YOKOGAWA's qualified personnel only. Opening the cover is dangerous, because some areas inside the instrument have high voltages.

**Ground the Instrument before Making External Connections**

Securely connect the protective grounding before connecting to the item under measurement or an external control unit. If you are going to touch the circuit, make sure to turn OFF the circuit and check that no voltage is present.

**Precautions to Be Taken When Using the Modules**

- Do not apply input voltage exceeding the maximum input voltage, withstand voltage, or allowable surge voltage.
- To prevent the possibility of electric shock, be sure to furnish protective earth grounding of the DL850/DL850V.
- To prevent the possibility of electric shock, be sure to fasten the module screws. Otherwise, the electrical protection function and the mechanical protection function will not be activated.
- Do not leave the modules connected to the instrument in environments in which a voltage that exceeds the allowable surge voltage may occur.

**Precautions to Be Taken When Using the Probes**

- When measuring high voltages using the 701250 (HS10M12) or 701251 (HS1M16), use an isolated probe (the 700929 or 701947), 1:1 safety cable (a combination of the 701901 and 701954), or differential probe (700924).
  - Be sure to connect the GND lead of the differential probe (the 700924) to the functional ground terminal of the DL850/DL850V. High voltage may appear at the BNC connector of the differential probe. Also, be sure to connect the GND lead to the DL850/DL850V before you connect to the device under measurement.
  - When using the 701255 (NONISO\_10M12), be sure to fasten the module screws. Fastening the module screws activates the protection function and the non-isolation function. It is extremely dangerous if you do not fasten the screws. Also, when you measure high voltages above 42 V, be sure to use the passive probe (the 701940).
  - The BNC portion of the passive probe (701940) is metal, so if you use it with isolated input (the 701250 (HS10M12), 701251 (HS1M16), 701260 (HV (with RMS)), etc.), for safety, be sure to only use it with voltages at or below 42 V. (Do not connect voltage above 42 V to both the High and Low sides.)  
For non-isolated inputs (701255 (NONISO\_10M12), etc.), fasten the module screws as described before.
  - When you apply high voltages to the 701260 (HV (with RMS)), use a 1:1 safety cable (a combination of the 701901 and 701954) or isolated probe (the 700929 or 701947).
  - The measurement category of the 701260 (HV (with RMS)) is 400V-CATII on the low side and 700V-CATII on the high side. Use caution because the overvoltage tolerance differs between the low and high sides.
- 

## Operating Environment Limitations

---

### **CAUTION**

This product is a Class A (for industrial environments) product. Operation of this product in a residential area may cause radio interference in which case the user will be required to correct the interference.

---

---

# Waste Electrical and Electronic Equipment



Waste Electrical and Electronic Equipment (WEEE), Directive 2002/96/EC  
(This directive is only valid in the EU.)

This product complies with the WEEE Directive (2002/96/EC) marking requirement. This marking indicates that you must not discard this electrical/electronic product in domestic household waste.

#### Product Category

With reference to the equipment types in the WEEE directive Annex 1, this product is classified as a "Monitoring and Control instrumentation" product.

When disposing products in the EU, contact your local Yokogawa Europe B. V. office. Do not dispose in domestic household waste.



---

# Symbols and Notation Used in This Manual

## Unit

k: Denotes 1000.

Example: 100 kS/s (sample rate)

K: Denotes 1024.

Example: 720 KB (file size)

## Displayed Characters

Bold characters in procedural explanations are used to indicate panel keys and soft keys that are used in the procedure and menu items that appear on the screen.

## Notes and Cautions

The notes and cautions in this manual are categorized using the following symbols.



*Improper handling or use can lead to injury to the user or damage to the instrument.* This symbol appears on the instrument to indicate that the user must refer to the user's manual for special instructions. The same symbol appears in the corresponding place in the user's manual to identify those instructions. In the manual, the symbol is used in conjunction with the word "WARNING" or "CAUTION."

### **WARNING**

Calls attention to actions or conditions that could cause serious or fatal injury to the user, and precautions that can be taken to prevent such occurrences.

### **CAUTION**

Calls attentions to actions or conditions that could cause light injury to the user or damage to the instrument or user's data, and precautions that can be taken to prevent such occurrences.

### **Note**

Calls attention to information that is important for proper operation of the instrument.

---

# Contents

Checking the Contents of the Package.....	ii
Safety Precautions.....	vii
Waste Electrical and Electronic Equipment.....	x
Symbols and Notation Used in This Manual.....	xi

## Chapter 1 Names and Functions of Parts

1.1 Top Panel, Front Panel, Right Side Panel, and Left Side Panel.....	1-1
1.2 Panel Keys and Knobs.....	1-6
1.3 Screens.....	1-10
1.4 System Configuration.....	1-12

## Chapter 2 Main Features

2.1 Vertical and Horizontal Axes.....	2-1
2.2 Triggering.....	2-4
2.3 Waveform Acquisition.....	2-7
2.4 Waveform Display.....	2-9
2.5 Waveform Computation and Analysis.....	2-10

## Chapter 3 Making Preparations for Measurements

3.1 Handling Precautions.....	3-1
3.2 Installing the Instrument.....	3-3
3.3 Installing Input Modules.....	3-5
▲ 3.4 Connecting to a Power Supply and Turning the Power Switch On and Off.....	3-9
▲ 3.5 Connecting Probes.....	3-12
▲ 3.6 Correcting the Probe Phase.....	3-18
▲ 3.7 Connecting Measuring Leads.....	3-20
▲ 3.8 Connecting Thermocouples.....	3-21
▲ 3.9 Connecting Bridgeheads.....	3-22
▲ 3.10 Connecting a Logic Probe to the Logic Input Module.....	3-25
▲ 3.11 Connecting an Acceleration Sensor.....	3-27
▲ 3.12 Connecting Sensors to the Frequency Module.....	3-29
▲ 3.13 Connecting Wires to the 16-CH Voltage Input Module.....	3-30
▲ 3.14 Connecting a Cable to the CAN Bus Monitor Module.....	3-32
3.15 Attaching the Panel Sheet.....	3-33

## Chapter 4 Common Operations

4.1 Key and Jog Shuttle Operations.....	4-1
4.2 Entering Values and Strings.....	4-3
4.3 Using USB Keyboards and Mouse Devices.....	4-5
4.4 Synchronizing the Clock.....	4-10
4.5 Performing Auto Setup.....	4-11
4.6 Initializing Settings.....	4-13
4.7 Calibrating the DL850/DL850V.....	4-14
4.8 Starting and Stopping Waveform Acquisition.....	4-15
4.9 Displaying Help.....	4-16

**Chapter 5 External Signal I/O**

▲ 5.1	External Trigger Input (TRIGGER IN).....	5-1
▲ 5.2	Trigger Output (TRIGGER OUT).....	5-2
▲ 5.3	External Clock Input (EXT CLK IN) .....	5-3
▲ 5.4	Video Signal Output (VIDEO OUT (XGA)) .....	5-4
▲ 5.5	GO/NO-GO Determination I/O and External Start/Stop Input (EXT I/O).....	5-5
▲ 5.6	IRIG Signal Input (IRIG option) .....	5-8

**Chapter 6 Specifications**

6.1	Signal Input Section .....	6-1
6.2	Triggering Section .....	6-1
6.3	Time Axis .....	6-2
6.4	Display.....	6-3
6.5	Features .....	6-3
6.6	FFT .....	6-6
6.7	Built-in Printer.....	6-6
6.8	Storage.....	6-7
6.9	USB for Peripherals.....	6-7
6.10	Auxiliary I/O Section .....	6-8
6.11	Computer Interface.....	6-9
6.12	General Specifications .....	6-11
▲ 6.13	Module Specifications .....	6-15
6.14	Logic Probe Specifications .....	6-43
6.15	External Dimensions .....	6-44

**Appendix**

Appendix 1	Relationship between the Time Axis Setting, Record Length, and Sample Rate.....	App-1
Appendix 2	Relationship between the Record Length and the Acquisition Mode .....	App-15
Appendix 3	Default Values .....	App-17
Appendix 4	USB Keyboard Key Assignments.....	App-21
Appendix 5	Block Diagrams .....	App-23

1

2

3

4

5

6

App

# 1.1 Top Panel, Front Panel, Right Side Panel, and Left Side Panel

## Top Panel

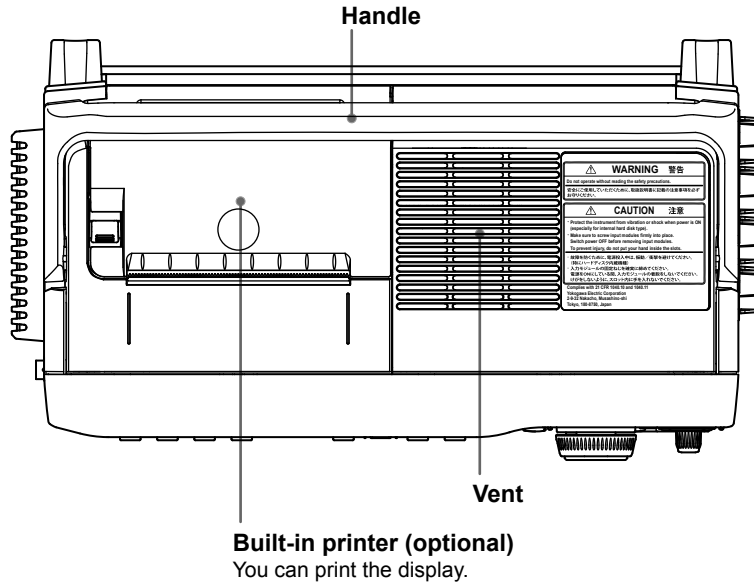

## Front Panel

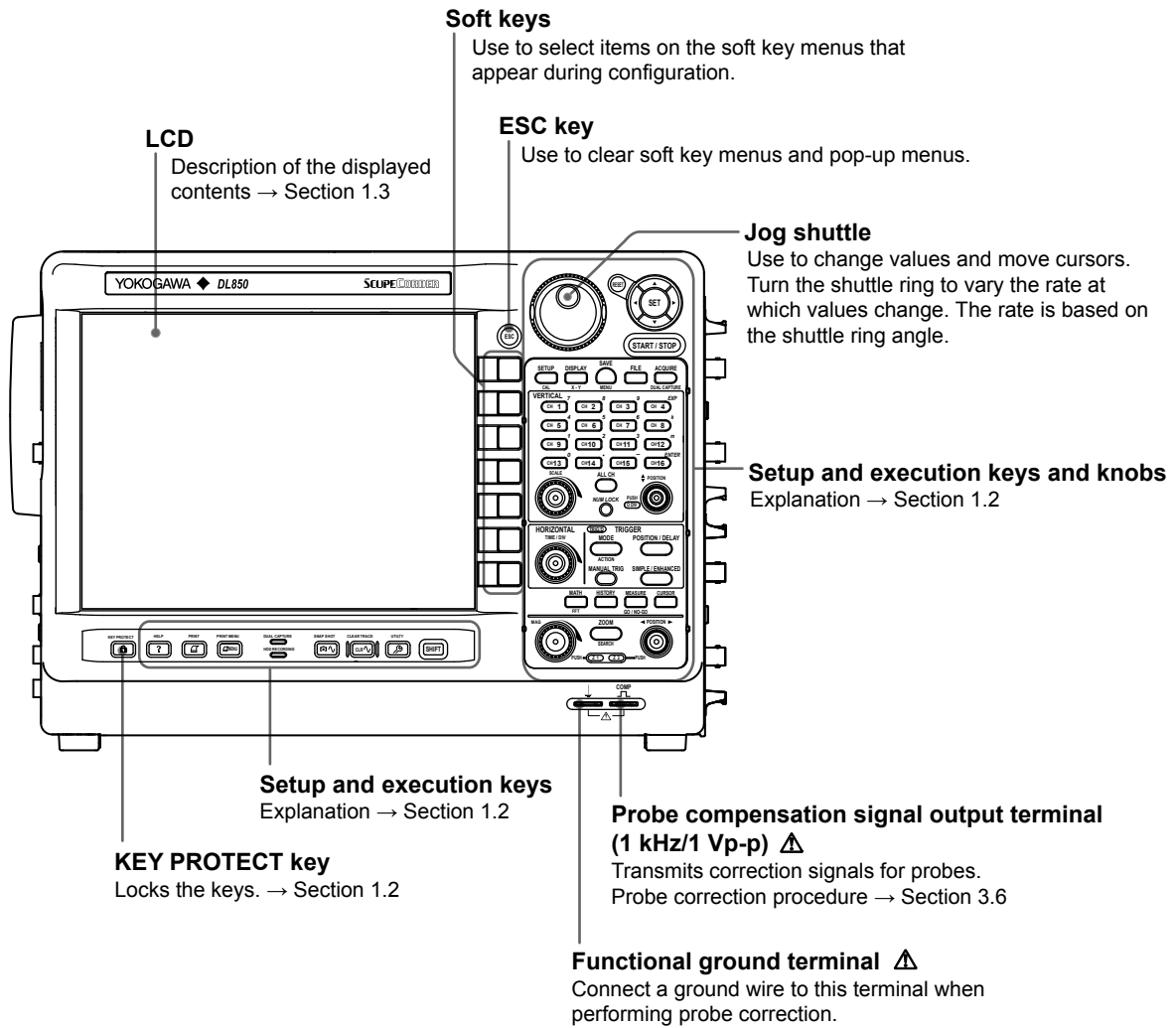

## Right Side Panel

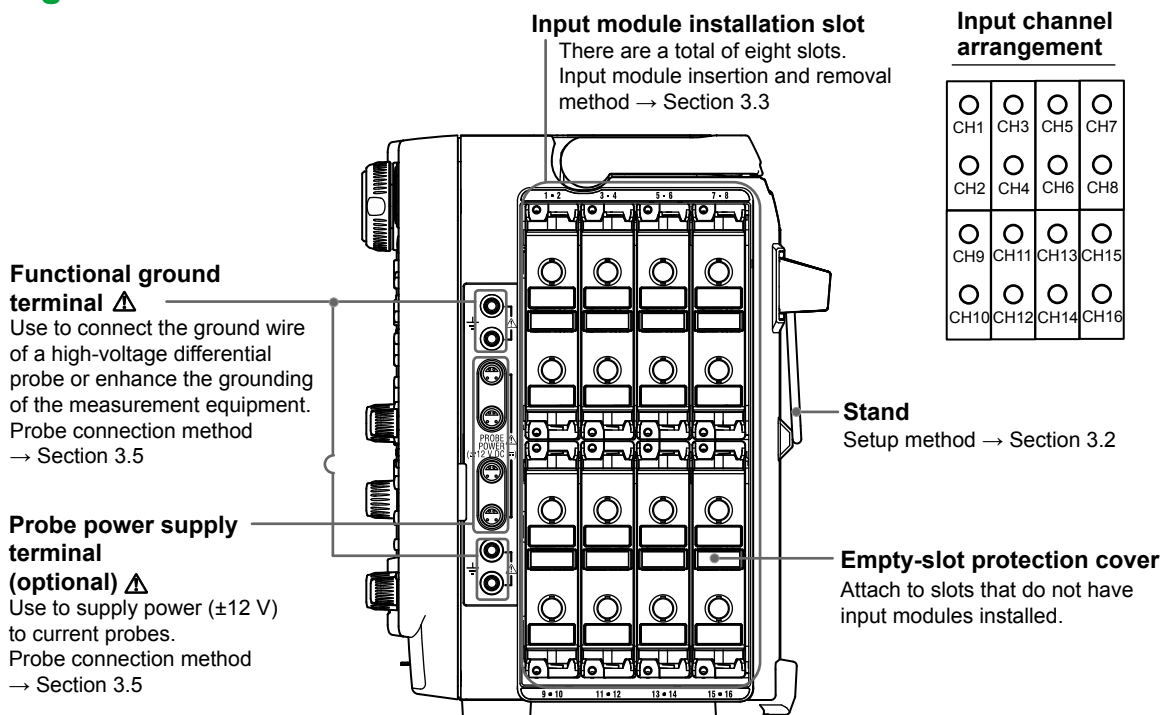

## Input Modules

The following 15 input modules are available.

**High-Speed 10 MS/s, 12-Bit Isolation Module HS10M12 (model: 701250)**

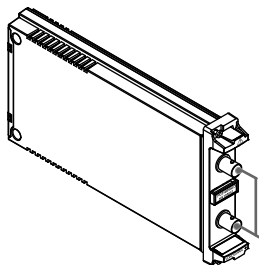

Signal input terminal (2ch)

**High-Speed High-Resolution 1 MS/s, 16-Bit Isolation Module HS1M16 (model: 701251)**

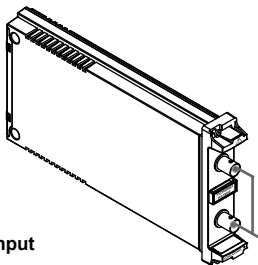

Signal input terminal (2ch)

**High-Speed 10 MS/s, 12-Bit Non-Isolation Module NONISO\_10M12 (model: 701255)**

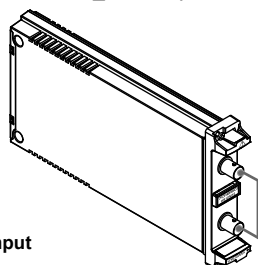

Signal input terminal (2ch)

**High-Voltage 100 kS/s, 16-Bit Isolation Module (with RMS) HV (with RMS) (model: 701260)**

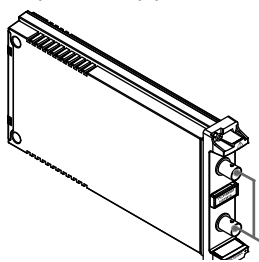

Signal input

**Universal (Voltage/Temp.) Module UNIVERSAL (model: 701261)**

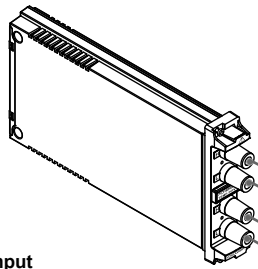

H input terminal  
L input terminal

**Universal (Voltage/Temp.) Module (with AAF) UNIVERSAL (AAF) (model: 701262)**

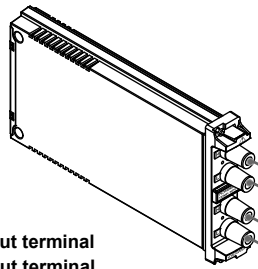

H input terminal  
L input terminal

## 1.1 Top Panel, Front Panel, Right Side Panel, and Left Side Panel

Temperature, High Precision  
Voltage Isolation Module  
TEMP/HPV (model: 701265)

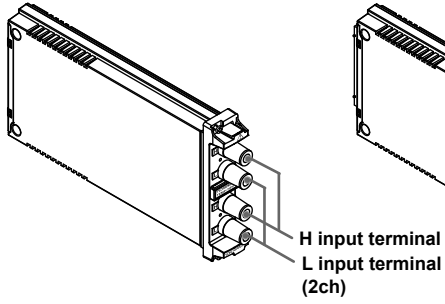

Strain Module (NDIS)  
STRAIN\_NDIS (model: 701270)

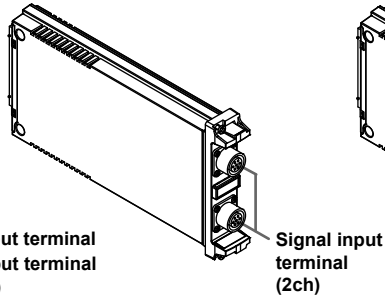

Strain Module (DSUB, Shunt-Cal)  
STRAIN\_DSUB (model: 701271)

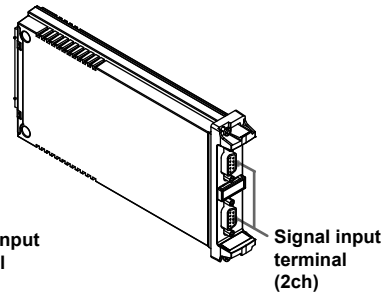

Acceleration/Voltage Module  
(with AAF)  
ACCL/VOLT (model: 701275)

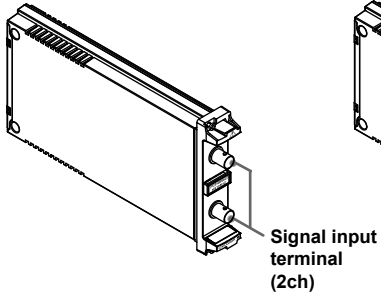

Frequency Module  
FREQ (model: 701280)

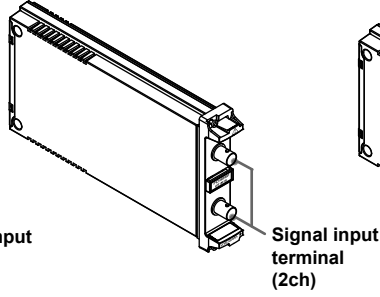

High-Speed 100 MS/s,  
12-Bit Isolation Module  
HS100M12 (model: 720210)

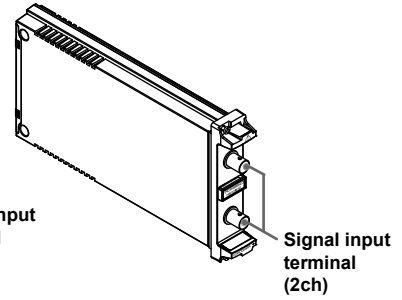

16-CH Voltage Input Module  
16CH VOLT (model: 720220)

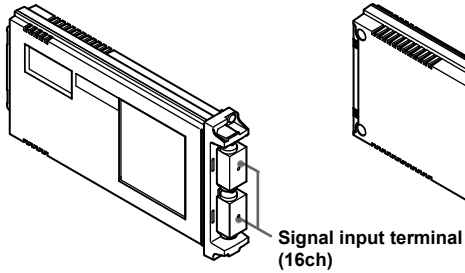

Logic Input Module  
LOGIC (model: 720230)

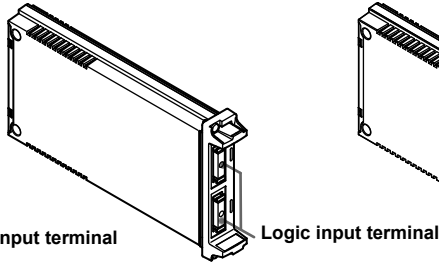

CAN Bus Monitor Module  
CAN MONITOR (model: 720240)

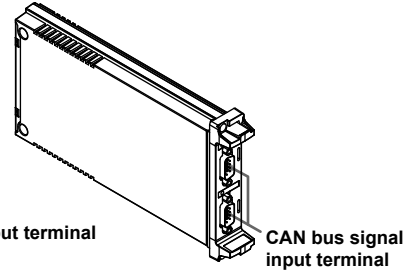

## Left Side Panel

### Video signal output terminal

You can output the displayed image in an XGA RGB signal.  
Explanation about how to use → Section 5.4

### GO/NO-GO and external start/stop I/O connector

Transmits GO/NO-GO determination I/O signals.  
Can also be used to start and stop the DL850/DL850V through external control.  
Explanation about how to use → Section 5.5

### Vent

### External-clock input terminal

Use when applying an external clock signal.  
Explanation about how to use → Section 5.3

### Main power switch

Turning the power on and off → Section 3.4

### Power inlet

Power connection → Section 3.4

### Name plate

### Trigger input terminal

Use when applying an external trigger signal.  
Explanation about how to use → Section 5.1

### Trigger output terminal

Use to transmit trigger signals.  
Explanation about how to use → Section 5.2

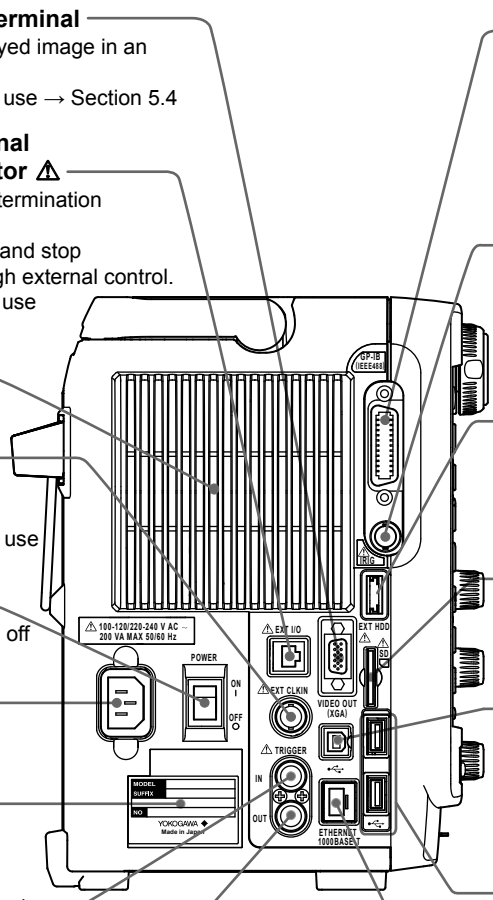

### GP-IB connector (optional)

Use to communicate with the DL850/DL850V through the GP-IB interface. For information about the DL's communication features, see the communications interface user's manual.

### IRIG input terminal (optional)

Use when applying an external synchronization signal (IRIG signal).  
Explanation about how to use → Section 5.6

### External HDD connector (optional)

Use to connect an external hard disk.  
Explanation about how to use → User's manual

### SD memory card slot

Use to connect an SD memory card.  
Explanation about how to use → User's manual

### USB port for PCs

Use to connect the DL850/DL850V to a PC that has a USB port.  
Explanation about how to use → Communication interface user's manual

### USB ports for peripherals

Use to connect a USB keyboard, mouse, or storage device.  
Explanation about how to use → Section 4.3 and User's manual

### Ethernet port (100BASE-TX)

Use to connect the DL850/DL850V to a LAN. Explanation about how to use → Feature's guide and communication interface user's manual



## 1.2 Panel Keys and Knobs

### Vertical Axis

#### CH1 to CH16 Keys

These keys display menus for turning the display of each channel on and off and configuring settings such as display label settings, input coupling settings, the probe attenuation or the current-to-voltage conversion ratio, the bandwidth limit, the vertical position, vertical zoom settings, the offset value, and linear scaling. Also, you can press a key to select the channel that the SCALE knob will control. Channel keys illuminate when their corresponding channel is on.

After you press NUM LOCK (see below), you can press a channel key to enter the number displayed to the upper right of the key in white.

#### ALL CH Key

Press this key to display a window in which you can configure all the settings from the menus that appear when you press CH1 to CH16. The settings appear in a list.

#### NUM LOCK Key

Press this key to use the CH1 to CH16 keys to enter numbers.

#### SCALE Knob

Use this knob to set the vertical scale. Before you turn this knob, select the target waveform by pressing a key from CH1 to CH16. If you change the scale while waveform acquisition is stopped, the setting actually takes effect when you restart waveform acquisition.

#### ◆POSITION Knob (Vertical POSITION Knob)

Use this knob to adjust the vertical display position (vertical position) of an input waveform. Before you turn this knob, select the target waveform by pressing a key from CH1 to CH16. This knob has a push switch. You can press the knob to reset the position to 0.00 div.

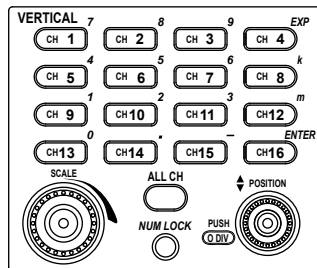

### Horizontal Axis

#### TIME/DIV knob

Use this knob to set the time-axis scale. If you change the scale while waveform acquisition is stopped, the scale change actually takes effect when you restart waveform acquisition.



## TRIGGER Group Keys

### (SHIFT+) MODE Key

Displays a menu for selecting the trigger mode. Press SHIFT and then MODE to display a menu for configuring action-on-trigger and action-on-stop settings.

### POSITION/DELAY Key

Press this key to set the trigger position and the trigger delay.

### MANUAL TRIG Key

Press this key to make the DL850/DL850V trigger regardless of the trigger settings.

### SIMPLE/ENHANCED Key

Displays a trigger setup menu.

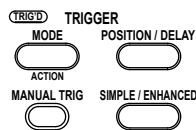

## Other Keys

### (SHIFT+) MATH Key

Displays a menu for waveform computation. Press SHIFT and then MATH to display a menu for configuring FFT computation.

### HISTORY Key

Displays a menu for using the history feature to recall data.

### (SHIFT+) MEASURE

Displays a menu for automated measurement of waveform parameters. Press SHIFT and then MEASURE to display a menu for GO/NO-GO determination.

### CURSOR Key

Displays a menu used when performing cursor measurements.

### (SHIFT+) ZOOM Key

Displays a waveform zoom display menu. Press SHIFT and then ZOOM to display a menu for data searching (the search & zoom function).

### MAG Knob

Use this knob to set the zoom factors for the Zoom1 and Zoom2 zoom boxes. This knob has a push switch. Press the MAG knob to switch the zoom box whose zoom factor is set by it.

### ◀POSITION▶ Knob (Zoom POSITION knob)

Use this knob to set the zoom position. This knob has a push switch. Press the POSITION knob to switch the zoom box whose zoom position is set by it.

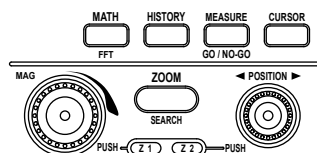

### RESET Key

Resets the value to its default value.

### SET Key

Press this key to select the menu item that you have moved the cursor to using the jog shuttle. You can also press the SET key to start entering a value or characters.

### Arrow Keys (▲▼▶◀ keys)

Use the ▶◀ keys to move the cursor between numeric digits. Use the ▲▼ keys to increment or decrement the value of a digit. You can also use the ▲▼ keys to select setup items.

### START/STOP Key

Starts and stops waveform acquisition according to the trigger mode. The key is illuminated while the DL850/DL850V is acquiring waveforms.

### (SHIFT+) SETUP Key

Displays a menu for initializing the settings to their factory defaults; performing auto setup, which automatically sets the DL850/DL850V according to the input signal; storing and recalling setup information; and so on. Press SHIFT and then SETUP to display a calibration menu.

### (SHIFT+) DISPLAY Key

Use this key to configure the display. Press SHIFT and then DISPLAY to display an X-Y display menu.

### (SHIFT+) SAVE Key

Press this key to save waveform or screen capture data to a storage medium. Press SHIFT and then SAVE to display a menu for configuring the save operation.

### FILE Key

Press this key to save or load data from a storage medium or to display a menu for file manipulation.

### (SHIFT+) ACQUIRE Key

Displays a menu used to set the waveform acquisition mode. Press SHIFT and then ACQUIRE to display a menu for configuring the dual capture feature.

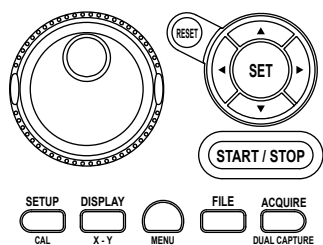

### KEY PROTECT Key

When you press this key, it illuminates, and the keys on the front panel are locked. Press the key again to unlock the keys.

### HELP Key

Turns on and off the help window, which explains various features.

### PRINT Key

Use this key to save and print screen capture data.

### PRINT MENU Key

Displays a menu for printing screen captures to the built-in printer or a network printer or displays a menu for saving screen capture data to a storage medium.



### SNAP SHOT Key

Retains the currently displayed waveforms on the screen in white. Snapshot waveforms can be saved and loaded.

### CLEAR TRACE Key

Clears the waveform acquired using the snap shot function and accumulated waveforms.

### UTILITY Key

Displays a menu for configuring system, communication, network, and environment settings; for performing self tests; and for displaying system information (information about installed modules, installed options, and the firmware version).

### SHIFT Key

Press this key once to access the features that are written in purple below each key. The shift key illuminates when the keys are shifted. Pressing the key again clears the shifted condition.



#### Note

Press SHIFT and then CLEAR TRACE to switch from remote mode to local mode. For details, see the communication interface user's manual.

### Notes about Using of Knobs

The vertical POSITION, ZOOM MAG, and ZOOM POSITION knobs have push switches. Push the knobs straight. If you push a knob at an angle, it may not operate properly. If this happens, push the knob straight one more time.

#### CAUTION

Do not push the knob sideways with strong force. Doing so may break the knobs.

# 1.3 Screens

## Normal Waveform Display

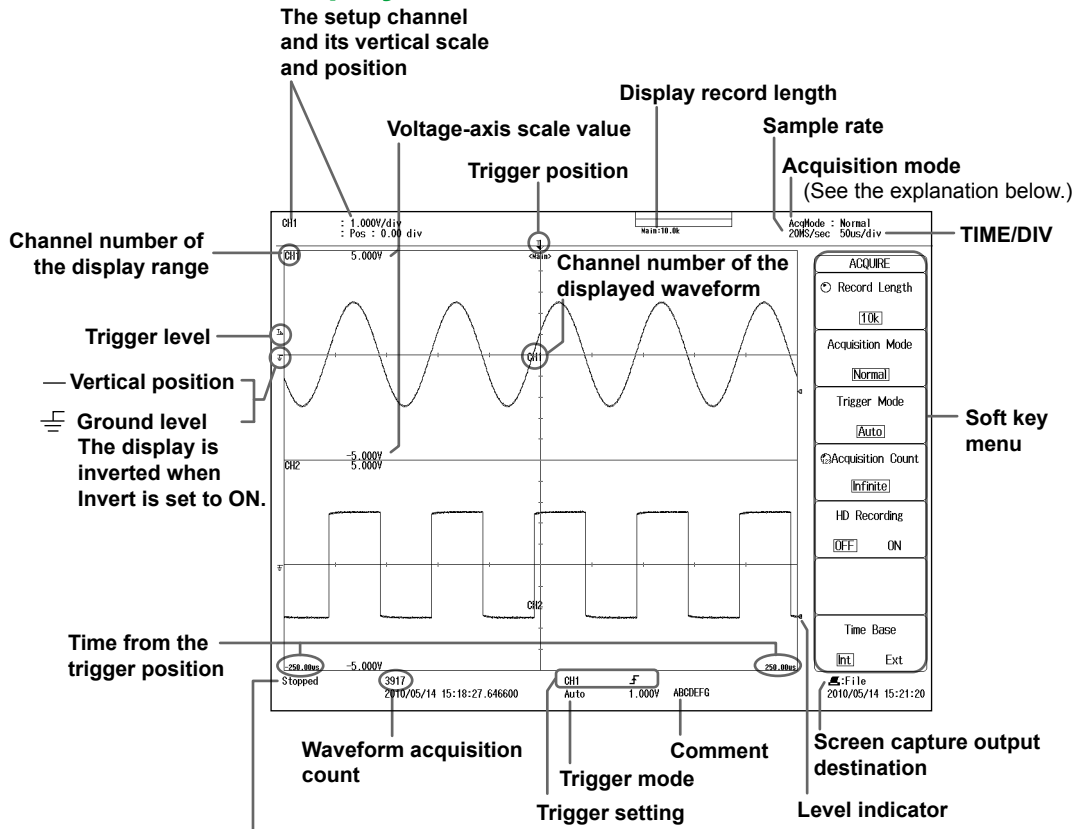

### Waveform acquisition condition

- Stopped
- Running
- Waiting for trigger
- HD out: Continuous writing to hard disk
- Pre... :Acquiring pre data
- Post... :Acquiring post data

## Acquisition Mode Indication

- Normal : Normal mode
- Env : Envelope mode
- Avg : Average mode
- BoxAvg : Box average mode

### Note

The DL850/DL850V LCD may include a few defective pixels. For details, see section 6.4, "Display."

## Zoom Waveform Display

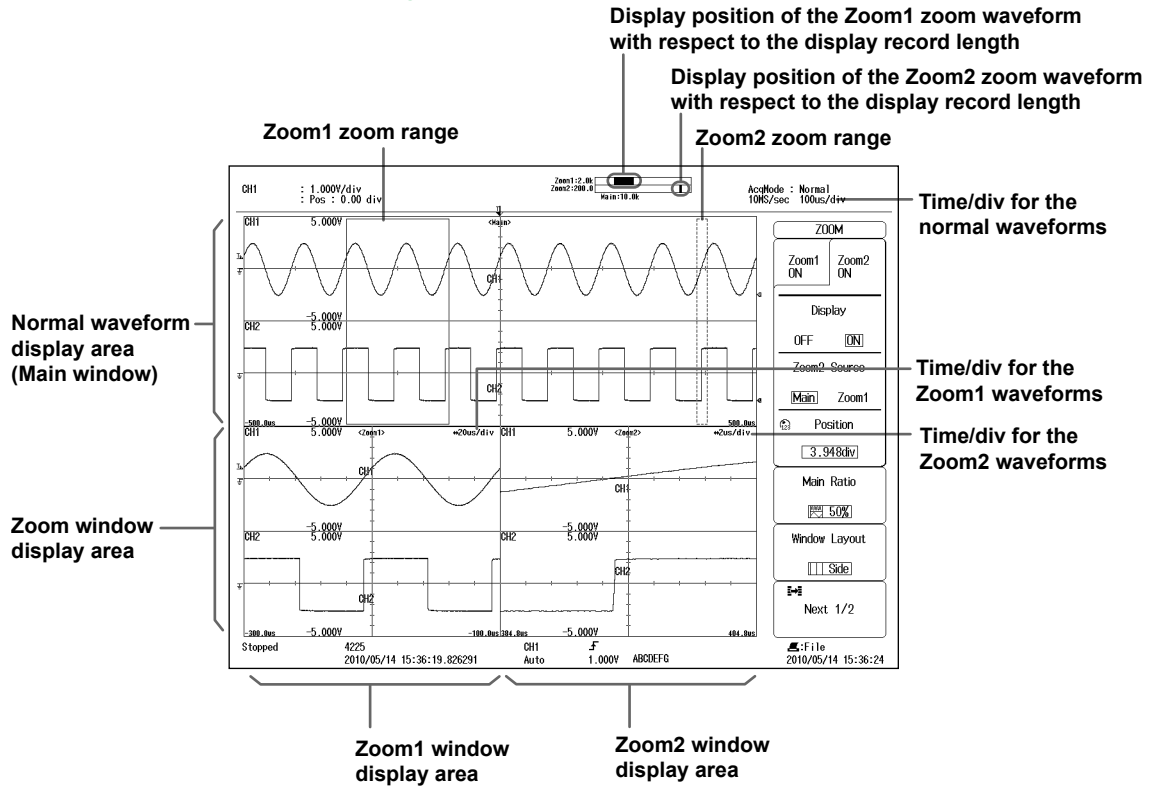

## Dual Capture Display

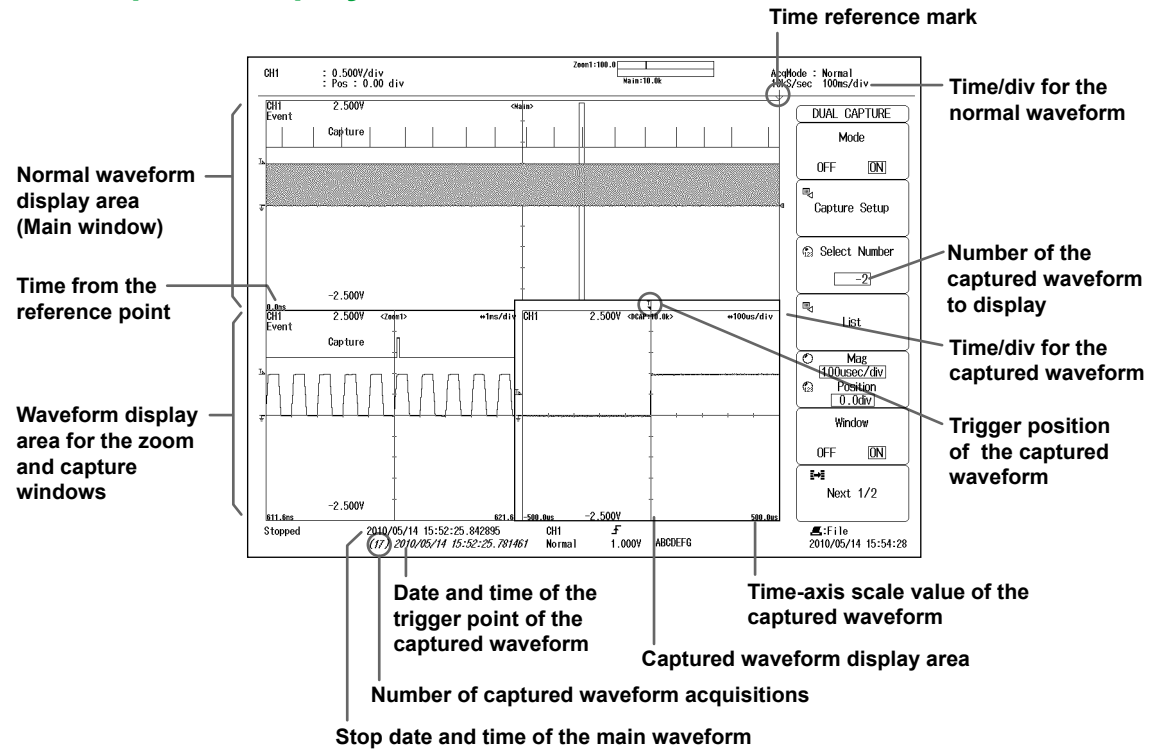

# 1.4 System Configuration

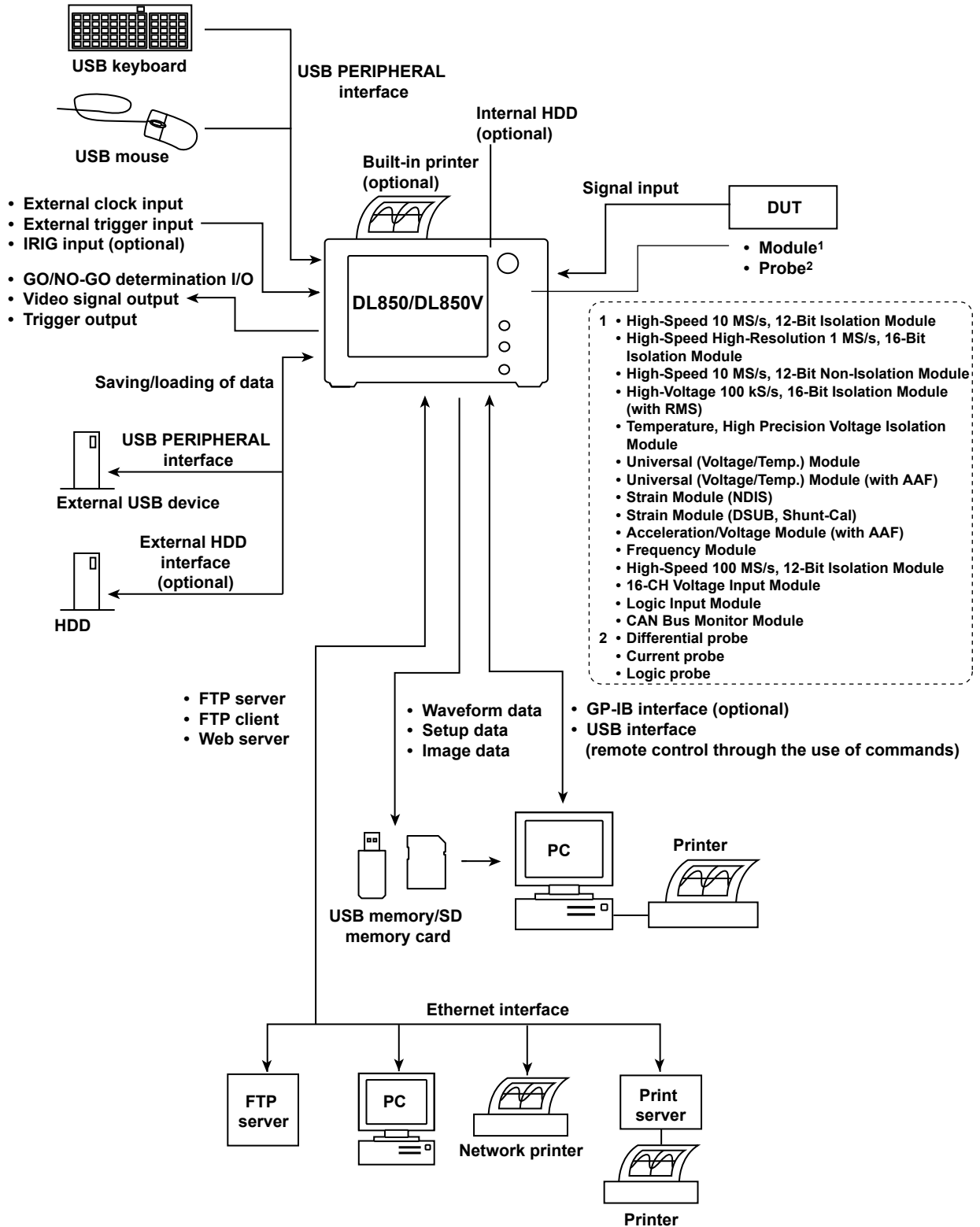

## 2.1 Vertical and Horizontal Axes

### Vertical Axis

This section explains how to configure the signal input settings and the amplitude-direction display settings. The items that can be set vary depending on the installed modules. The channel menu that corresponds to the key you pressed (CH1 to CH16) appears. You can set the various vertical axis settings for each channel. Press ALL CH to display a screen in which you can configure the settings of all channels while viewing the settings in a list.

### DL850/DL850V Measurement Items

When the DL850/DL850V is equipped with the modules listed below, it can monitor CAN bus signals and measure voltage, temperature, strain, acceleration, frequency, logic, and so on.

#### Voltage

701250 (HS10M12), 701251 (HS1M16), 701255 (NONISO\_10M12), 701260 (HV (with RMS)), 720210 (HS100M12), 701261 (UNIVERSAL), 701262 (UNIVERSAL (AAF)), 701265 (TEMP/HPV), 701275 (ACCL/VOLT)

#### Voltage (For the 16-CH Voltage Input Module)

720220 (16CH VOLT)

#### Temperature

701261 (UNIVERSAL), 701262 (UNIVERSAL (AAF)), 701265 (TEMP/HPV)

#### Strain

701270 (STRAIN\_NDIS), 701271 (STRAIN\_DSUB)

#### Acceleration

701275 (ACCL/VOLT)

#### Frequency

701280 (FREQ)

#### Logic

720230 (LOGIC)

#### CAN Bus Signal Monitoring

720240(CAN MONITOR)

This module can only be used with the DL850V.

### Vertical Scale

The vertical scale is used to adjust the displayed waveform amplitude so that you can easily view signals. You can set the vertical scale to determine the value per grid square (1 div) displayed on the screen and to set the measurement range.

Use the SCALE knob to set the vertical scale for each channel.

### Vertical Position

Because the DL850/DL850V can display many waveforms, the waveforms may overlap and be difficult to view. If this happens, you can adjust the vertical display position to make waveforms easier to view (vertical position).

Use the POSITION knob to set the vertical position for each channel.



### Input Coupling

You can change the input coupling setting to match the signal that you are measuring. By changing the setting, you can choose how the vertical-axis (voltage-axis) control circuit is coupled to the input signal. The following types of input coupling are available: DC, AC, GND, TC, DC-RMS, AC-RMS, ACCEL, and OFF.\*Set the appropriate input coupling for each input module.

\* You can only select OFF for sub channels on the 16-CH Voltage Input Module. Sub channels set to OFF are not measured.

### Vertical Zoom

You can zoom the waveform vertically. You can zoom the waveform by setting the vertical magnification or by setting upper and lower display limits.

### Linear Scaling

Linear scaling is a function that converts measured values into physical values and reads them directly. There two types of linear scaling:

#### AX + B

Using scaling coefficient A and offset B, the DL850/DL850V scales values according to the equation below.

$Y = AX + B$  (where X is the measured value and Y is the physical value)

#### P1-P2

The DL850/DL850V determines the scale conversion equation ( $y = ax + b$ ) using four values that you specify: two measured values (P1:X, P2:X) and the value that each one should be converted to (P1:Y, P2:Y).

The DL850/DL850V scales values using the scale conversion equation that it determines.

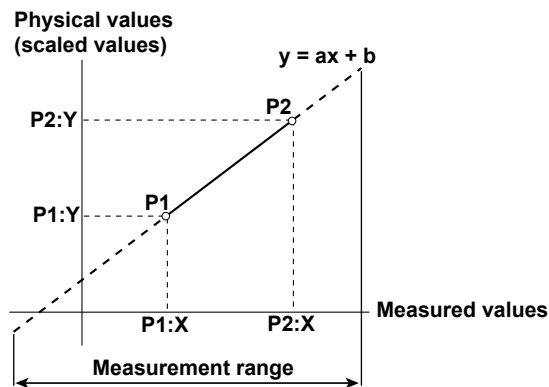

## Horizontal Axis (Time Axis)

### Time Axis Setting

Normally, under the initial settings, the time axis scale is set as a length of time per grid division (1 div). The selectable range is 100 ns/div to 3 days/div. As you adjust the value, the unit changes between seconds, minutes, hours, and days automatically. Because the horizontal display range is 10 div, the amount of time on the waveform that is displayed is equal to the time axis setting  $\times$  10.

- \* When the 720210 (HS100M12) module is installed, the scale range starts at 100 ns/div; when it is not installed, the scale range starts at 1  $\mu$ s/div.

### Internal and External Clocks (Time base selection)

Under the initial settings, the DL850/DL850V samples the measured signal using the internal clock signal produced by its internal time-base circuit.

You can also use an external clock signal to control sampling. Apply the external clock signal to the external clock input terminal. This external clock input is useful for synchronizing to the clock signal of the waveform that is being measured.

### Relationship between the Time Axis Setting, Record Length, and Sample Rate

If you change the time axis setting, the sample rate and the acquisition-memory record length also change. For details, see appendix 1.

#### Sample Rate

If you change the time axis setting, the sample rate also changes. The sample rate is the number of samples-per-second (S/s). When the sample rate is low compared to the frequency of the input signal, the high-frequency components of the waveform are misread as low-frequency components. To prevent the high-frequency components from being misread, sample the signal at the highest sample rate possible, or set the waveform acquisition mode to Envelope.

#### Roll Mode Display

When the trigger mode is Auto, Auto Level, Single, or On Start and the time axis setting is 100 ms/div or longer, instead of updating waveforms through triggering (update mode), the DL850/DL850V displays the waveforms in roll mode. In roll mode, waveforms scroll from right to left as new data is captured and the oldest values are deleted from the screen.

## 2.2 Triggering

A trigger is a cue used to display the waveform on the screen. A trigger occurs when the specified trigger condition is met, and a waveform is displayed on the screen.

### Trigger Modes

The trigger mode determines the conditions for updating the displayed waveforms. There are six trigger modes: Auto, Auto Level, Normal, Single, N Single, and On Start. The trigger mode setting applies to all trigger types.

### Trigger Types

Triggers can be broadly divided into “simple triggers” and “enhanced triggers.”

#### Simple Triggers

##### Input Signal Trigger

The DL850/DL850V triggers when the trigger source passes through the specified trigger level in the specified way (rising edge, falling edge, or rising or falling edge).

##### Time Trigger

The DL850/DL850V triggers at the specified date and time and at specified intervals afterwards.

##### External Signal Trigger

The DL850/DL850V triggers when the signal applied to the TRIG IN terminal passes through the specified trigger level in the specified way (rising or falling edge).

##### Power Line Signal Trigger

The DL850/DL850V triggers on the rising edge of the power supply signal that it is receiving. This trigger enables you to observe waveforms in synchronization with the power supply frequency.

#### Enhanced Triggers

##### A→B(N) Trigger

After state condition A is met, the DL850/DL850V triggers when state condition B is met N times.

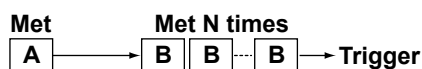

##### A Delay B Trigger

After state condition A is met and the specified amount of time elapses, the DL850/DL850V triggers when state condition B is first met.



### Edge On A Trigger (Enhanced)

While state condition A is met, the DL850/DL850V triggers on the OR of multiple trigger source edges.

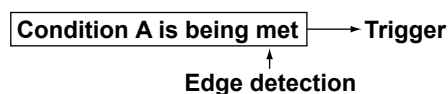

### OR Trigger

The DL850/DL850V triggers on the OR of multiple trigger source edges.

### AND Trigger

The DL850/DL850V triggers on the AND of multiple trigger source conditions. The DL850/DL850V triggers when all the specified conditions are met at a single point.

### Period Trigger

The DL850/DL850V triggers on a specified period of occurrence of state condition B. The DL850/DL850V triggers when state condition B occurs again.

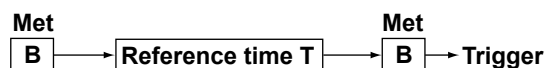

### Pulse Width Trigger

The DL850/DL850V triggers according to the relationship between the state condition B achievement time and the specified reference times (Time or T1 and T2).

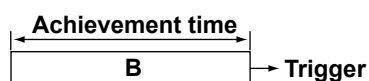

### Wave Window Trigger

The DL850/DL850V creates real-time templates (Wave Window) using a number of cycles directly preceding the current waveforms. The DL850/DL850V compares the current waveforms to the real-time templates and triggers if one of the current waveforms falls outside of its real-time template.

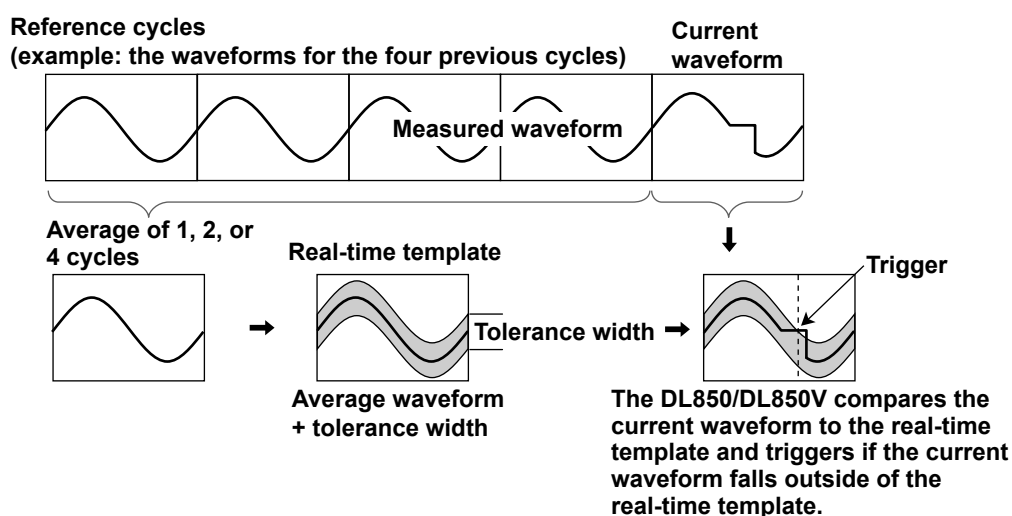

### Trigger Source

*Trigger source* refers to the signal that is used to check the specified trigger conditions. You can set the trigger source to an analog signal, logic signal, time, external signal, or power line signal. Select the appropriate trigger source for the trigger type.

### Trigger Level

*Trigger level* refers to the signal level used as a reference for detecting a signal's rising and falling edges or high and low states. With simple triggers such as the edge trigger, the DL850/DL850V triggers when the trigger source level passes through the specified trigger level. The range and resolutions that you can use to set the trigger level vary depending on the type of signal being measured.

### Trigger Slope

*Slope* refers to the movement of the signal from a low level to a high level (rising edge) or from a high level to a low level (falling edge). When a slope is used as one of the trigger conditions, it is called a trigger slope.

### Trigger Hysteresis

When the trigger source is an analog signal, you can set a width (hysteresis) to the trigger level so that the DL850/DL850V does not detect edges when the signal level changes within the specified width. You can set the hysteresis around the trigger level for each type of measured signal.

### Trigger Hold-off

The trigger hold-off feature temporarily stops the detection of the next trigger once a trigger has occurred. This feature is useful in cases when you want to change the waveform acquisition interval, such as when you are observing a PCM (pulse code modulation) code or other pulse train signal or when you are using the history feature.

### Trigger Position

When you move the trigger position, the ratio of the displayed data before the trigger point (pre-data) to the data after the trigger point (post-data) changes. When the trigger delay is 0 s, the trigger point and trigger positions coincide.

### Trigger Delay

The DL850/DL850V normally displays waveforms before and after the trigger point. You can set a trigger delay to display waveforms at a specified amount of time after the trigger occurrence.

## 2.3 Waveform Acquisition

Based on the data that has been stored in the acquisition memory, the DL850/DL850V performs various operations, such as displaying waveforms on the screen, computing, measuring cursors, and automatically measuring waveform parameters.

You can set the number of data points to store in the acquisition memory (the record length), enable or disable the sample data averaging feature, and so on.

### Record Length

*Record length* refers to the number of data points that are stored to the acquisition memory for each channel. *Display record length* refers to the data points from the data stored in the acquisition memory that are displayed on the screen. Normally, the acquisition-memory record length and display record length are the same, but the time axis setting may cause them to differ. When you change the time axis setting, the sample rate and record length also change.

On the standard model of the DL850/DL850V, you can set the record length to a value between 1 kpoint and 250 Mpoint. Depending on the model, you can set the record length to a value of up to 2 Gpoint.

### Acquisition Mode

Specify how the DL850/DL850V processes the sampled data, stores it in the acquisition memory, and uses it to display waveforms. There are four acquisition modes: Normal, Envelope, Averaging, and BoxAverage.

### Hard Disk Recording

When measurement starts, you can record data to an external hard disk that supports eSATA (external Serial ATA; /HD0 option) or to an internal hard disk (/HD1 option).<sup>\*</sup> The recorded data is saved to files automatically. You can load the saved data using the DL850/DL850V and convert it to a format that you can analyze on a PC (ASCII or floating point).

<sup>\*</sup> Models with the /HD0 option are equipped with eSATA connectors. You need to purchase a hard disk that supports eSATA separately.

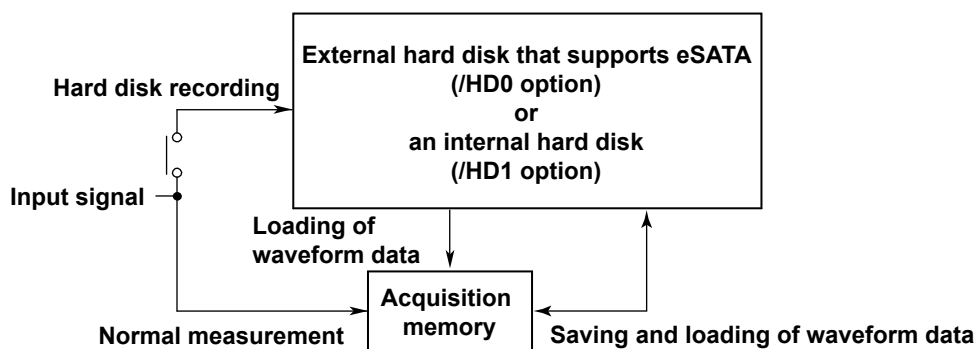

## History

When waveforms are being measured, the waveform data stored in the acquisition memory as a result of a trigger occurrence is displayed as a waveform on the DL850/DL850V screen and can be viewed. When waveform acquisition is being triggered in succession and an abnormal waveform appears, it is impossible to stop acquisition before a new waveform appears on the screen. Normally, it would be impossible to view the abnormal waveform. However, with the history feature, you can view the past waveform data (history waveforms) stored in the acquisition memory when waveform acquisition is stopped. You can select specific history waveforms and display them.

You can also search through the history waveforms for waveforms that meet specified conditions.

- Zone Search

The DL850/DL850V searches for history waveforms that passed (or did not pass) through a specified search zone.

- Waveform Parameter Search

The DL850/DL850V searches for waveforms whose measured waveform parameter values meet (or do not meet) specified conditions.

### Zone Search

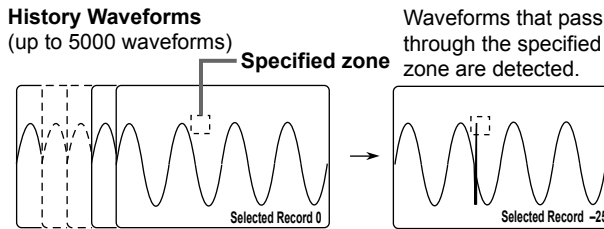

### Waveform parameter search

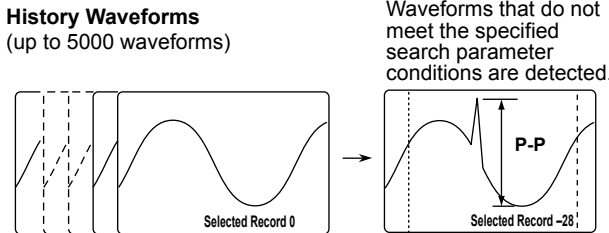

## Dual Capturing

You can use dual capturing to simultaneously record a trend at a low sampling speed in roll mode and at a high sampling rate. This is useful for capturing fast phenomenon while observing a trend over a long period of time.

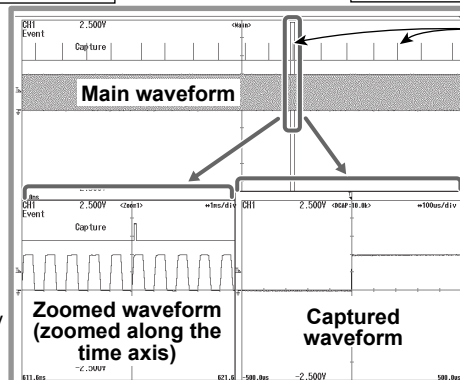
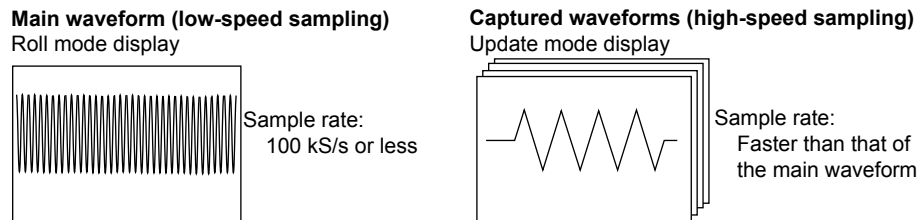

**Events**  
The points where triggering occurred during dual capturing are displayed as events.

Because there is not enough sampled data, the shape of the waveform may not be displayed correctly.

Because the data is sampled at a high speed, the correct shape of the waveform is displayed.





## 2.5 Waveform Computation and Analysis

### Waveform Computation

You can perform basic arithmetic, binarization, FFT (power spectrum), and phase shifting (display the waveform with its phase shifted). On models with the /G2 option, you can use a rich variety of functions (square root, trigonometric functions, differentiation, integration, digital filtering, six types of FFT functions, and so on) to define up to eight equations.

**Expression configuration dialog box**  
Use the soft keyboard on the screen to enter an expression.

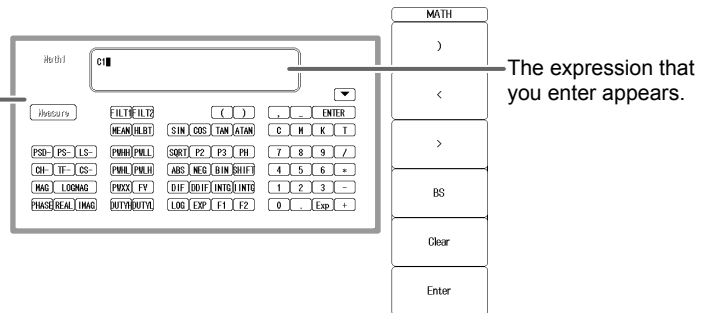

### Cursor Measurement

There are cursors for T-Y (time-axis), X-Y, and FFT waveforms. You can position a cursor over a waveform to view the various measured values at the intersection of the cursor and the waveform.

### Automated Measurement of Waveform Parameters

You can use this feature to automatically measure waveform levels, maximum values, frequencies, and other values. For up to 100 Mpoint of waveform data, you can measure 29 waveform parameters (including the delay between channels) that relate to the voltage axis, time axis, and waveform area.

- You can display a total of 32 measured values for all the waveforms.
- You can save a total of 64000 items of data for all the waveforms.
- You can also perform computations on measured waveform parameter values.
- You can display the following statistics for the specified waveform parameter.

The maximum value (Maximum), minimum value (Minimum), average value (Average), standard deviation (SDev), and number of measured values used to calculate statistics (Count)

**Setup Dialog Box**

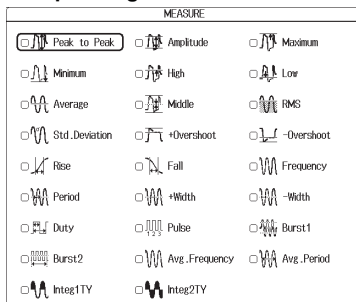

**Example of Displayed Statistical Values**

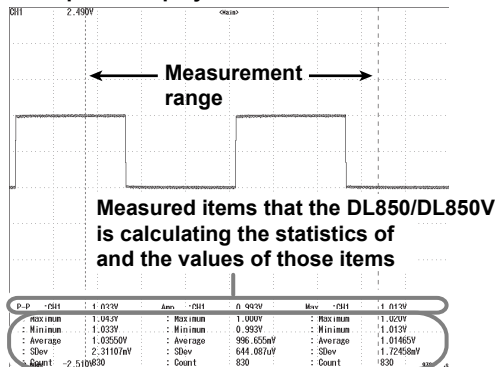

Maximum: Maximum value      Minimum: Minimum value  
Average: Average value      SDev: Standard deviation  
Count: Number of measured values used to calculate statistics

There are three statistical processing methods:

- Normal statistical processing  
While acquiring waveforms, the DL850/DL850V measures the measurement items and calculates the statistics of the waveforms that it has acquired so far.
- Cyclic statistical processing (measurement and statistical processing are performed for each period)  
The DL850/DL850V divides the waveform into periods starting at the left side of the screen (the oldest waveform) and moving to the right side of the screen, measures the selected measurement items within each period, and performs statistical processing on the measurement items.
- Statistical processing of history waveforms  
The DL850/DL850V measures the measurement items and calculates the statistics of history waveforms. Measurement and statistical processing begin with the oldest waveform.

## GO/NO-GO Determination

This feature is useful for signal testing on production lines and for tracking down abnormal phenomena. The DL850/DL850V determines whether the waveform enters the specified range. When the DL850/DL850V returns a GO (or NO-GO) result, specified actions are performed.

### Determination Methods

- Waveform Zone

The DL850/DL850V returns GO/NO-GO results based on whether waveforms leave or enter the zone that you create using a base waveform.

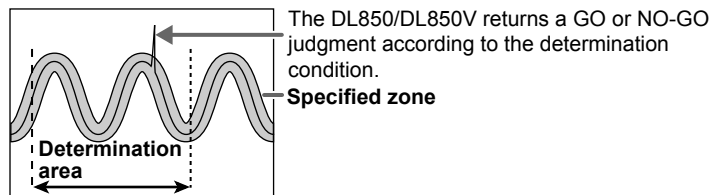

- Waveform Parameter

Set the upper and lower limits for automated measurement values of waveform parameters. The DL850/DL850V performs GO/NO-GO determination based on whether the values are within or outside of the limits.

### Actions Performed according to Determination Results

The DL850/DL850V can print and save screen captures, save waveform data, beep, and send e-mails according to the results of GO/NO-GO determination.

## 3.1 Handling Precautions

### Safety Precautions

If you are using this instrument for the first time, make sure to thoroughly read the safety precautions given on page viii.

#### Do Not Remove the Case

Do not remove the case from the instrument. Some sections inside the instrument have high voltages and are extremely dangerous. For internal inspection and adjustment, contact your nearest YOKOGAWA dealer.

#### Unplug If Abnormal Behavior Occurs

If you notice smoke or unusual odors coming from the instrument, immediately turn off the power and unplug the power cord. If such an irregularity occurs, contact your dealer.

#### Do Not Damage the Power Cord

Nothing should be placed on the power cord. The cord should be kept away from any heat sources. When unplugging the power cord from the outlet, never pull by the cord itself. Always hold and pull by the plug. If the power cord is damaged, contact your dealer for replacement. Refer to page iv for the part number to use when placing an order.

### General Handling Precautions

#### Do Not Place Objects on Top of the Instrument

Never place other instruments or objects containing water on top of the instrument, otherwise a breakdown may occur.

#### Do Not Apply Shock or Vibration

Do not apply shock or vibration. Doing so may damage the instrument. Extra caution is needed for the optional internal hard disk, because it is sensitive to vibration and shock. Shocks to the input connectors or probes may turn into electrical noise and enter the instrument via the signal lines.

#### Do Not Damage the LCD

Since the LCD screen is very vulnerable and can be easily scratched, do not allow any sharp objects near it. Also it should not be exposed to vibrations and shocks.

#### Unplug during Extended Non-Use

Unplug the power cord from the outlet.

## 3.1 Handling Precautions

---

### When Carrying the Instrument

Remove the power cord and connecting cables. When moving the instrument, use the handle as shown below, or carry it with both hands.

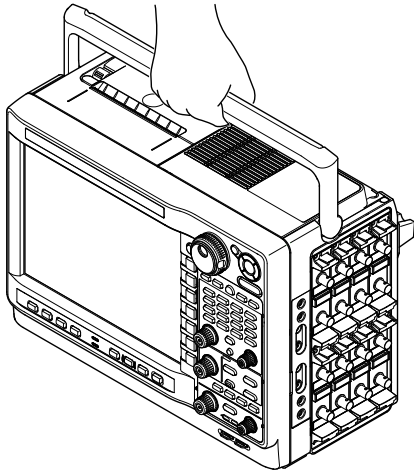

### Cleaning

When cleaning the case or the operation panel, first remove the power cord from the AC outlet. Then, wipe with a dry, soft, clean cloth. Do not use chemical such as benzene or thinner. These can cause discoloring and deformation.

## 3.2 Installing the Instrument

### Installation Conditions

Install the instrument in a place that meets the following conditions.

#### Flat, Even Surface

Install the instrument in the correct orientation (see page 3-4) in a safe place, with no tilting from front to back or left to right (when you install the instrument with the rear panel facing down, you can tilt it on its stand). The recording quality of the printer may be hindered when the instrument is placed in an unstable or inclined place.

#### Well-Ventilated Location

There are inlet holes on the bottom side of the instrument. There are also vent holes for the cooling fan on the left side panel and the top panel. To prevent internal overheating, allow for enough space around the instrument (see the figure below) and do not block the inlet and exhaust holes.

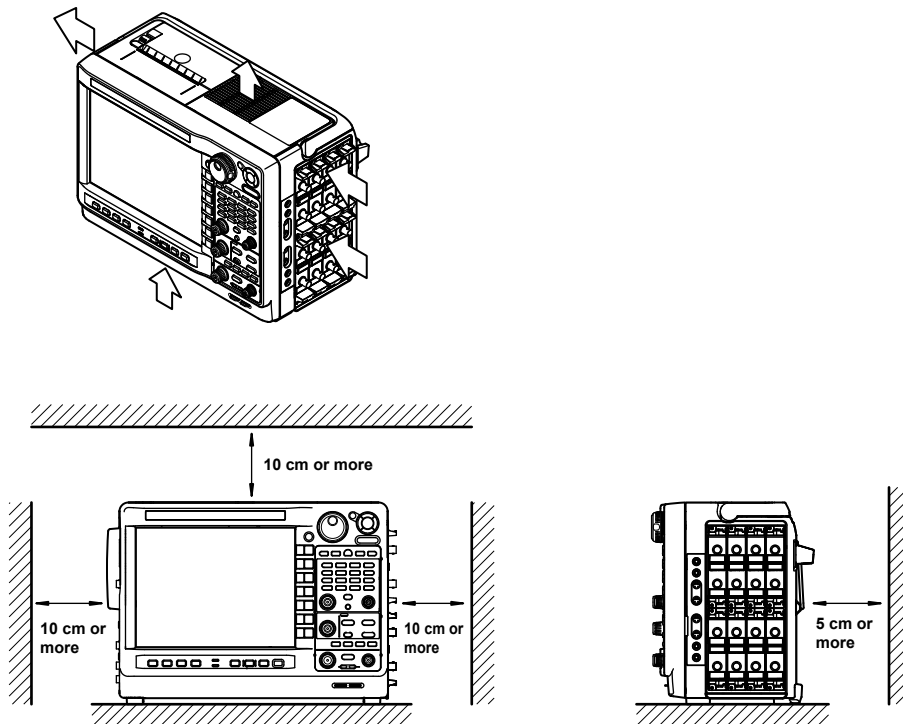

When connecting cables and opening and closing the cover of the built-in printer, provide extra operating space in addition to the space in the figure shown above.

### Ambient Temperature and Humidity

Ambient temperature: 5 to 40°C

Ambient humidity: 20 to 85% RH (when the printer is not used; no condensation)  
35 to 85% RH (when the printer is used)

#### Note

- To ensure high measurement accuracy, operate the instrument in the  $23 \pm 5^\circ\text{C}$  temperature range and 20 to 80% RH.
- Condensation may occur if the instrument is moved to another place where the ambient temperature is higher, or if the temperature changes rapidly. In such cases, allow the instrument adjust to the new environment for at least an hour before using the instrument.

## 3.2 Installing the Instrument

---

### Do not install the instrument in the following places.

- In direct sunlight or near heat sources.
- Where an excessive amount of soot, steam, dust, or corrosive gas is present.
- Near strong magnetic field sources.
- Near high voltage equipment or power lines.
- Where the level of mechanical vibration is high.
- On an unstable surface.

### Installation Position

Install the instrument so that it is flat or with the rear panel facing down. When using the stand as shown in the bottom right figure, push it out until it locks into place. Push the stand back in when you store the instrument.

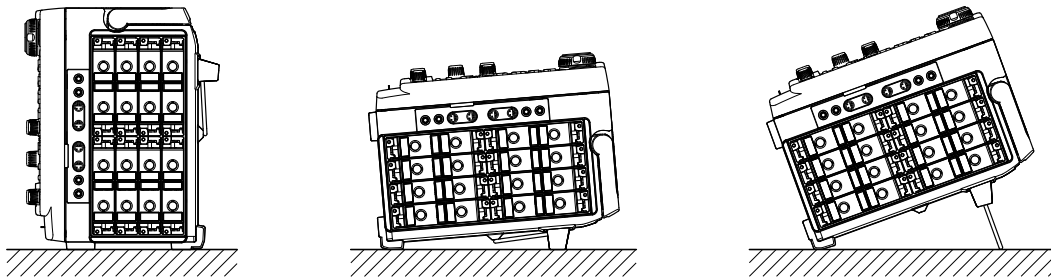

### Rubber Stoppers

If the instrument is installed so that it is flat as shown in the above figure, rubber stoppers can be attached to the feet to prevent the instrument from sliding. One set of rubber stoppers (four stoppers) are included in the package.

## 3.3 Installing Input Modules



### WARNING

- To prevent electric shock and damage to the instrument, be sure to turn the power off before you install or remove input modules.
- Check that the input cable is not connected to the input terminals before installing or removing the input module.
- To prevent electric shock and to satisfy the specifications, make sure to put the accessory cover plate on the slots that are not being used.  
Using the instrument without the cover plate allows the dust to enter the instrument and may cause malfunction due to the rise in temperature inside the instrument.
- If the input module happens to come out of the slot while it is in use, it may cause electric shock or cause damage to the instrument as well as the input module. Make sure to screw the input module in place at the two locations (top and bottom).
- There are protrusions in the slot. Do not put your hand in the slot. If you put your hand in the slot, the protrusions may cut your hand.

#### Precautions to Be Taken When Using the Modules

- Do not apply input voltage exceeding the maximum input voltage, withstand voltage, or allowable surge voltage.
- To avoid electric shock, be sure to ground the instrument.
- To prevent the possibility of electric shock, be sure to fasten the module screws. Failing to do so is extremely dangerous, because the electrical and mechanical protection functions will not be activated.
- Do not leave the instrument connected to devices in an environment that may be subject to voltage surges.
- When measuring high voltages using the 720210 (HS100M12), 701250 (HS10M12), or 701251 (HS1M16), use an isolated probe (the 700929 or 701947), 1:1 safety cable (a combination of the 701901 and 701954), or differential probe (700924).
- Be sure to connect the GND lead of the differential probe (the 700924) to the functional ground terminal of the DL850/DL850V before you connect to the device under measurement. High voltage may appear at the BNC connector of the differential probe.
- The protection functions and non-isolation functions of the 701255 (NONISO\_10M12) are enabled when the module screws are tightened. It is extremely dangerous if you do not fasten the screws. Also, when you measure high voltages above 42 V, be sure to use the passive probe for the DL850/DL850V (the 701940).
- The BNC portion of the 10 MHz passive probe (701940) is metal, so if you use it with isolated input (the 720210 (HS100M12), 701250 (HS10M12), 701251 (HS1M16), 701260 (HV (with RMS)), 701275 (ACCL/VOLT), or 701280(FREQ)), for safety, be sure to only use it with voltages at or below 42 V. (Do not connect voltage above 42 V to both the High and Low sides.)
- When you apply high voltages to the 701260 (HV (with RMS)), use a 1:1 safety cable (a combination of the 701901 and 701954) or isolated probe (the 700929 or 701947).
- The measurement category of the 701260 (HV (with RMS)) is 400V-CATII on the low side and 700V-CATII on the high side. Use caution because the overvoltage tolerance differs between the low and high sides.
- When you apply high voltages to the 701280 (FREQ), use an isolated probe (the 700929 or 701947).
- The protection functions and non-isolation functions of the 720230 (LOGIC) are enabled when the module screws are tightened. It is extremely dangerous if you do not fasten the screws. Also, be sure to only use a recommended YOKOGAWA logic probe (700986, 700987, 702911, or 702912) with the logic module.

## Types of Input Modules

The following 14 types of input modules are available.

High-Speed 100 MS/s, 12-Bit Isolation Module	720210 (HS100M12)
High-Speed 10 MS/s, 12-Bit Isolation Module	701250 (HS10M12)
High-Speed High-Resolution 1 MS/s, 16-Bit Isolation Module:	701251 (HS1M16)
High-Speed 10 MS/s, 12-Bit Non-Isolation Module	701255 (NONISO_10M12)
High-Voltage 100 kS/s, 16-Bit Isolation Module (with RMS)	701260 (HV (with RMS))
Universal (Voltage/Temp.) Module	701261 (UNIVERSAL)
Universal (Voltage/Temp.) Module (with AAF)	701262 (UNIVERSAL (AAF))
Temperature, High Precision Voltage Isolation Module	701265 (TEMP/HPV)
Strain Module (NDIS)	701270 (STRAIN_NDIS)
Strain Module (DSUB, Shunt-Cal)	701271 (STRAIN_DSUB)
Acceleration/Voltage Module (with AAF)	701275 (ACCL/VOLT)
Frequency Module	701280 (FREQ)
16-CH Voltage Input Module	720220 (16CH VOLT)
Logic Input Module	720230 (LOGIC)
CAN Bus Monitor Module*	720240 (CAN MONITOR)

\* The CAN bus monitor module can be used on the DL850V. It cannot be used on the DL850.

## Precautions to Be Taken When Installing or Removing Input Modules

If you replace one installed input module with another, the settings for the channel will be reset to their defaults when the power is turned on. If you want to keep the settings, specify a save destination and save them.

## Installation Procedure of Modules

1. Make sure that the power switch on the left side panel of the instrument is turned off.
2. Check the channel number displayed above the input module installation slot on the right side panel of the instrument, and then install the input module along the guide.  
Holding the handles on the top and bottom of the input module, press hard until it clicks in place. If there is a cover plate on the slot in which to install the module, remove the cover plate, first.
3. Firmly fasten the screws that came with the instrument in two places: the top and bottom of the input module. (screw tightening torque: 0.6 N•m)
4. Turn the instrument's power switch on.
5. In the overview screen, check that the name of the module that you installed is displayed correctly at the appropriate channel number. If it is not correct, remove the module according to the steps in "Removal" shown below, and reinstall the module according to steps 1 to 3 shown above. To display the overview screen, see section 19.4, "Viewing System Information (Overview)," in the user's manual.

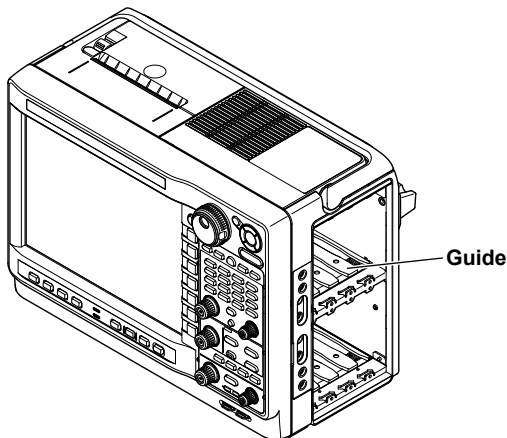

### Note

You can install up to four of the High-Speed 100 MS/s, 12-Bit Isolation Modules (HS100M12). You can only install them in the top slots.



## Removal

1. Make sure that the instrument's power switch is off.
2. Loosen the two screws that are fastened to the input module.
3. Hold the two handles at the top and bottom of the input module, and pull it out.

## About the High-speed, 100 MS/s, 12-bit Isolated Module

### Safety Precautions for Laser Products

The High-Speed 100 MS/s, 12-Bit Isolation Module (720210 (HS100M12)) uses an internal laser light source. The 720210 (HS100M12) is a class 1 laser product as defined by IEC60825-1: Safety of Laser Products—Part1: Equipment Classification.

#### High-Speed 100 MS/s, 12-Bit Isolation Module (720210 (HS100M12))

The following information is printed on the side.

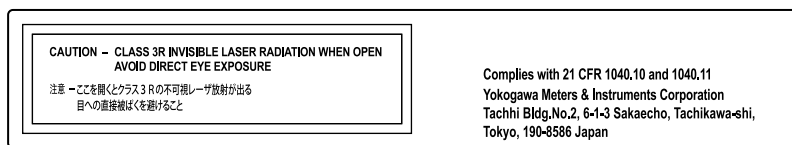

#### DL850/DL850V

The following information is printed on the top.



## Laser Specifications

Center wavelength: 850 nm

Pulse width: ≤ 10 ms (100 MHz), ≤ 2.5 ns (2 GHz)

Output: ≤ 1 mW

If the instrument is used in a manner not specified in this manual, the protection provided by the instrument may be impaired. YOKOGAWA assumes no liability for the customer's failure to comply with these warnings and requirements.

## LEDs on the Frequency Module

On the front panel of the frequency module (701280 (FREQ)) are LEDs for each channel. These LEDs allow you to check the input condition of the pulse.

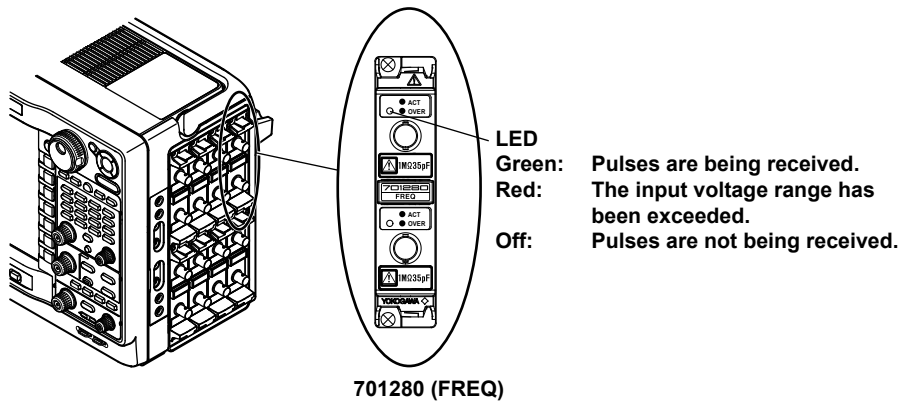

### Note

---

- The LEDs on the frequency module illuminate in green when a pulse is applied and red when the input voltage level is over range. It is independent of the start/stop condition of waveform acquisition of the DL850/DL850V.
  - When the preset of the frequency module is set to EM Pickup (electromagnetic pickup), the LED will not illuminate in red when the range is exceeded.
- For information about presets, see section 1.6, "Configuring Frequency, Revolution, Period, Duty Cycle, Power Supply Frequency, Pulse Width, Pulse Integration, and Velocity Measurements," in the user's manual.
-

## 3.4 Connecting to a Power Supply and Turning the Power Switch On and Off

### Before Connecting the Power

Make sure that you observe the following points before connecting the power. Failure to do so may cause electric shock or damage to the instrument.



### WARNING

- Before connecting the power cord, ensure that the source voltage matches the rated supply voltage of the instrument and that it is within the maximum rated voltage of the provided power cord.
- Connect the power cord after checking that the power switch of the instrument is turned off.
- To prevent the possibility of electric shock or fire, be sure to use the power cord for the instrument that was supplied by YOKOGAWA.
- To avoid electric shock, be sure to ground the instrument. Connect the power cord to a three-prong power outlet with a protective earth terminal.
- Do not use an extension cord without a protective earth ground. Otherwise, the protection function will be compromised.
- If an AC outlet that conforms to the accessory power cord is unavailable and protective grounding cannot be furnished, do not use the instrument.

### Connecting the Power Cord

1. Check that the power switch is off.
2. Connect the power cord plug to the power inlet on the left side panel.
3. Connect the other end of the cord to an outlet that meets the conditions below. Use the three-prong power outlet equipped with a protective earth terminal.

Rated supply voltage*	100 to 120 VAC/200 to 240 VAC
Permitted supply voltage range	90 to 132 VAC/180 to 264 VAC
Rated supply voltage frequency	50/60 Hz
Permitted supply voltage frequency range	48 to 63 Hz
Maximum power consumption	Approx. 200 VA max. (This value is for reference. When the built-in printer is not being used and there are 16 active channels, the maximum power consumption is 135 VA.)

\* The instrument can use a 100 V or a 200 V power supply. The maximum rated voltage differs according to the type of power cord. Check that the voltage supplied to the DL850/DL850V is less than or equal to the maximum rated voltage of the provided power cord (see page iii) before using it.

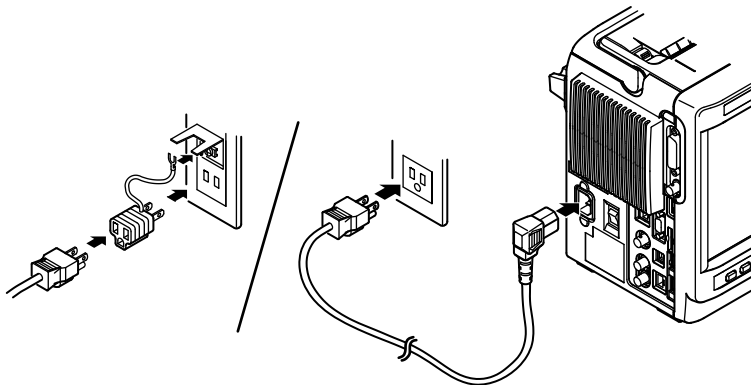

## Turning the Power Switch On and Off

### Before Turning On the Power, Check That:

- The instrument is installed properly (see section 3.2, “Installing the Instrument”).
- The power cord is connected properly (see the previous page).

### Turning the Power Switch On and Off

Flip the power switch on the left side panel to ON (I) to turn the instrument on, and to OFF (O) to turn the instrument off.

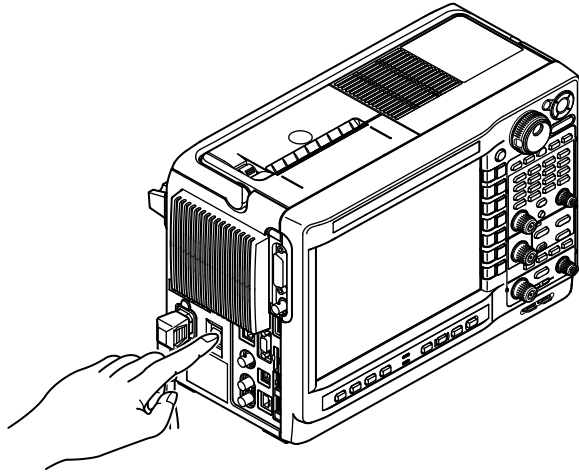

## Operations Performed When the Power Is Turned On

When the power switch is turned on, self testing and calibration start automatically. This lasts for approximately 30 seconds. If testing and calibration finish normally, the waveform display screen appears.

### Note

---

- After turning the power off, wait at least 10 seconds before you turn it on again.
  - If the instrument does not perform the operations described above after the power is turned on, turn the power off, and check:
    - That the power cord is plugged in properly.
    - That the correct voltage is coming to the power outlet (see the previous page).
  - After checking the above, try turning on the power switch while holding down the RESET key to initialize the settings (reset them to their factory defaults). For details about initializing the settings, see section 4.6, “Initializing Settings.”

If the instrument still does not work properly, contact your nearest YOKOGAWA dealer for repairs.
  - It takes several seconds for the startup screen to appear.
-

#### To Make Accurate Measurements

- After turning on the power switch, wait at least 30 minutes to allow the instrument to warm up.
- Perform calibration after the instrument has warmed up (see section 4.7 for details). If auto calibration is turned on, auto calibration is executed when you change the Time/div setting or start waveform acquisition.

#### Operations Performed When the Power Is Turned Off

When the power switch is turned off (or the power plug is removed), the instrument stores the current settings in its memory. This means that if you turn the power switch on and begin measurement, the instrument will perform measurements using the settings from immediately before the instrument was last turned off.

#### **Note**

---

The instrument stores the settings using an internal lithium battery. The battery lasts for approximately five years when the ambient temperature is 23°C. When the lithium battery voltage falls below a specified value and you turn on the power, a message (error 907) appears on the screen. If this message appears frequently, you need to replace the battery soon. Do not try to replace the battery yourself. Contact your nearest YOKOGAWA dealer to have the battery replaced.

---

## 3.5 Connecting Probes

### Connecting Probes

Connect the probes (or other input cables such as BNC cables) to any of the input terminals of the following modules. The input impedance is  $1\text{ M}\Omega \pm 1\%$  and approximately 35 pF.

- High-Speed 100 MS/s, 12-Bit Isolation Module: 720210 (HS100M12)
- High-Speed 10 MS/s, 12-Bit Isolation Module: 701250(HS10M12)
- High-Speed High-Resolution 1 MS/s, 16-Bit Isolation Module: 701251 (HS1M16)
- High-Speed 10 MS/s, 12-Bit Non-Isolation Module: 701255 (NONISO\_10M12)
- High-Voltage 100 kS/s, 16-Bit Isolation Module (with RMS): 701260 (HV(with RMS))
- Acceleration/Voltage Module (with AAF): 701275 (ACCL/VOLT)
- Frequency Module: 701280 (FREQ)

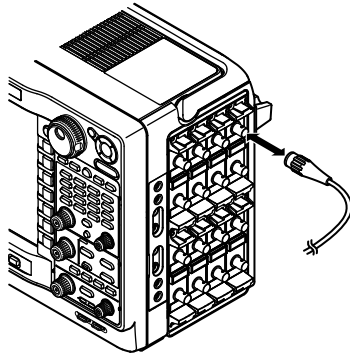

### WARNING

- When connecting a device under measurement to the instrument, be sure to turn off the device. It is extremely dangerous to connect or remove measuring leads while the device under measurement is on.

#### Precautions to Be Taken When Using the Modules

- Do not apply input voltage exceeding the maximum input voltage, withstand voltage, or allowable surge voltage.
- To avoid electric shock, be sure to ground the instrument.
- To prevent the possibility of electric shock, be sure to fasten the module screws. Otherwise, the electrical protection function and the mechanical protection function will not be activated.
- Do not leave the instrument connected to devices in an environment that may be subject to voltage surges.
- Use only specified cables. It is extremely dangerous to use cables that do not meet the safety standards. (Especially when you are handling high voltages of 42 V or more.)
- When measuring high voltages using the 720210 (HS100M12), 701250 (HS10M12), or 701251 (HS1M16), use an isolated probe (the 700929 or 701947), 1:1 safety cable (a combination of the 701901 and 701954), or differential probe (700924).
- When you apply high voltages to the 701260 (HV (with RMS)), use a 1:1 safety cable (a combination of the 701901 and 701954) or isolated probe (the 700929 or 701947).
- The BNC portion of the 10 MHz passive probe (701940) is metal, so if you use it with isolated input (the 720210 (HS100M12), 701250 (HS10M12), 701251 (HS1M16), 701260 (HV (with RMS)), 701275 (ACCL/VOLT), or 701280(FREQ)), for safety, be sure to only use it with voltages at or below 42 V. (Do not connect voltage above 42 V to both the High and Low sides.)For non-isolated inputs (701255 (NONISO\_10M12), etc.), fasten the module screws.
- The measurement category of the 701260 (HV (with RMS)) is 400V-CATII on the low side and 700V-CATII on the high side. Use caution because the overvoltage tolerance differs between the low and high sides.
- When you apply high voltages to the 701280 (FREQ), use an isolated probe (the 700929 or 701947).

**In Using the High Voltage Differential Probes**

Be sure to connect the GND lead of a differential probe (the 700924 or 700925) to the functional ground terminal on the right side panel of the instrument. Otherwise, high voltage may appear at the BNC connector making it dangerous.

**Maximum Input Voltages and Maximum Allowable Common Mode Voltages for the Modules**

Applying a voltage exceeding the value indicated below may damage the input section. If the frequency is above 1 kHz, damage may occur even when the voltage is below this value.

- **For the 720210 (HS100M12)**

Maximum input voltage (at a frequency of 1 kHz or less)

- When used with the 700929 (10:1) isolated probe or the 701947 (100:1) isolated probe.<sup>1</sup>  
1000 V (DC + ACpeak)
- With the safety cable (1:1; a combination of the 701901 and 701954)<sup>5</sup> or direct input<sup>9</sup>  
200 V (DC + ACpeak)

Maximum allowable common mode voltage (at a frequency of 1 kHz or less)

- When used with the 700929 (10:1) isolated probe or the 701947 (100:1) isolated probe.<sup>2</sup>  
Or when used with the safety cable (1:1; a combination of the 701901 and 701954).<sup>8</sup>  
1000 Vrms (CAT II)
- Direct input<sup>10</sup>  
42V (DC + ACpeak, CAT I and CAT II, 30 Vrms)

- **High-Speed 10 MS/s, 12-Bit Isolation Module (701250)**

Maximum input voltage (at a frequency of 1 kHz or less)

- When used with the 700929 (10:1) isolated probe or the 701947 (100:1) isolated probe.<sup>1</sup>  
600 V (DC + ACpeak)
- Safety cable (1:1) (combined with 701901+701954)<sup>5</sup> or direct input<sup>9</sup>  
250 V (DC+ACpeak)

Maximum allowable common mode voltage (at a frequency of 1 kHz or less)

- When used with the 700929 (10:1) isolated probe or the 701947 (100:1) isolated probe.<sup>2</sup>  
Or when used with the safety cable (1:1; a combination of the 701901 and 701954).<sup>8</sup>  
400 Vrms (CAT I), 300 Vrms (CAT II)
- Direct input<sup>10</sup>  
42 V (DC + ACpeak, CAT I and CAT II, 30 Vrms)

- **High-Speed High-Resolution 1 MS/s, 16-Bit Isolation Module (701251)**

Maximum input voltage (at a frequency of 1 kHz or less)

- When used with the 700929 (10:1) isolated probe or the 701947 (100:1) isolated probe.<sup>1</sup>  
600 V (DC+ACpeak)
- Safety cable (1:1) (combined with 701901+701954)<sup>5</sup> or direct input<sup>9</sup>  
140 V (DC+ACpeak)

Maximum allowable common mode voltage (at a frequency of 1 kHz or less)

- When used with the 700929 (10:1) isolated probe or the 701947 (100:1) isolated probe.<sup>2</sup>  
Or when used with the safety cable (1:1; a combination of the 701901 and +701954).<sup>8</sup>  
400 Vrms (CAT I), 300 Vrms (CAT II)
- Direct input<sup>10</sup>  
42 V (DC+ACpeak, CAT I and CAT II, 30 Vrms)

- **High-Speed 10 MS/s, 12-Bit Non-Isolation Module (701255)**

This module is non-isolated. Be sure to fasten the module screws when measuring a voltage above 42 V on this module. In addition, use the dedicated non-isolated passive probe (10:1) (701940).

Maximum input voltage (at a frequency of 1 kHz or less)

- Combined with the passive probe (701940) (10:1)  
600 V (DC+ACpeak)
- Direct input<sup>9</sup>  
250 V (DC+ACpeak)

### 3.5 Connecting Probes

- **High-Voltage 100 kS/s, 16-Bit Isolation Module (with RMS) (701260)**

Maximum input voltage (at a frequency of 1 kHz or less)

- When used with the 700929 (10:1) isolated probe or the 701947 (100:1) isolated probe.<sup>1</sup>  
1000 V (DC+ACpeak)
- Safety cable (1:1) (combined with 701901+701954)<sup>5</sup> or direct input<sup>9</sup>  
850 V (DC+ACpeak)

Maximum allowable common mode voltage (at a frequency of 1 kHz or less)

- When used with the 700929 (10:1) isolated probe or the 701947 (100:1) isolated probe.  
1000 Vrms (CAT II) on the H side,<sup>3</sup> 400 Vrms (CAT II)<sup>4</sup> on the L side
- Safety cable (1:1) (combined with 701901+701954)  
700 Vrms (CAT II) on the H side,<sup>6</sup> 400 Vrms (CAT II) on the L side<sup>7</sup>
- Direct input<sup>10</sup>  
42 V (DC+ACpeak, CAT I and CAT II, 30 Vrms)

- **701275 (ACCL/VOLT)**

Maximum input voltage (at a frequency of 1 kHz or less)

- Combined with the passive probe (701940) (10:1)<sup>11</sup> or direct input<sup>9</sup>  
42 V (DC+ACpeak)

Maximum allowable common mode voltage (at a frequency of 1 kHz or less)

- Combined with the passive probe (701940) (10:1)<sup>12</sup> or direct input<sup>10</sup>  
42 V (DC+ACpeak, CAT I and CAT II, 30 Vrms)

- **701280 (FREQ)**

Maximum input voltage (at a frequency of 1 kHz or less)

- When used with the 700929 (10:1) isolated probe or the 701947 (100:1) isolated probe.<sup>1</sup>  
420 V (DC + ACpeak)
- Safety cable (1:1) (combined with 701901+701954)<sup>5</sup> or direct input<sup>9</sup>  
42 V (DC + ACpeak)

Maximum allowable common mode voltage (at a frequency of 1 kHz or less)

- When used with the 700929 (10:1) isolated probe or the 701947 (100:1) isolated probe.<sup>2</sup>  
400 Vrms (CAT I), 300 Vrms (CAT II)
- Safety cable (1:1) (combined with 701901+701954)<sup>8</sup> or direct input<sup>10</sup>  
42 V (DC+ACpeak, CAT I and CAT II, 30 Vrms)

**With the 700929 or 701947**

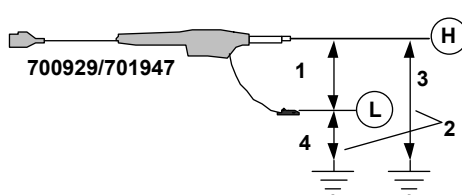

**With the 701901 and 701954**

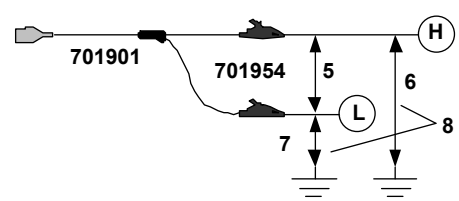

**Direct input (cable that does not comply with the safety standards)**

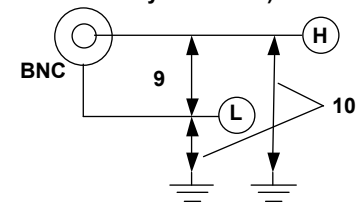

**With the 10:1 passive probe (701940)**

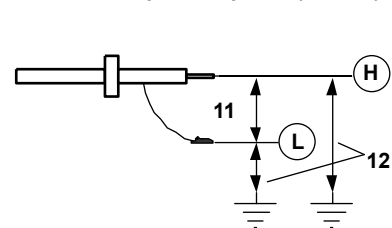



## Precautions to Be Taken When Connecting Probes

- When connecting a probe to the instrument for the first time, perform phase correction of the probe as described in section 3.7, “Compensating the Probe (Phase Correction).” Failure to do so will cause unstable gain across different frequencies, thereby preventing correct measurement. Make the phase correction on each channel to which the probe is to be connected.
- You cannot perform phase correction of the probe on the frequency module (701280(FREQ)). When connecting a probe to the 701280 (FREQ), first perform phase correction on the probe using another module.
- If the object to be measured is connected to the instrument directly, without using a probe, a correct measurement cannot be performed due to the input impedance. Please be aware of this.
- Please be aware that if you use a voltage probe that is not an isolated probe (the 700929 or 701947) and whose attenuation is not 1:1, 10:1, 100:1, or 1000:1, the correct measured values cannot be displayed.
- Follow the instructions given in section 5.6, “Setting the Probe Type” to set the probe attenuation (type) to match the actual value using the soft key menu. If they do not match, measured values cannot be read correctly.

## Connecting Current Probes

When using current probes made by YOKOGAWA,\* use the probe power supply (optional) on the right side panel of the DL850/DL850V.

\* YOKOGAWA current probes: the 700937, 701930, 701931, and 701933

For details on the connection procedure, see the manual that came with the current probe.

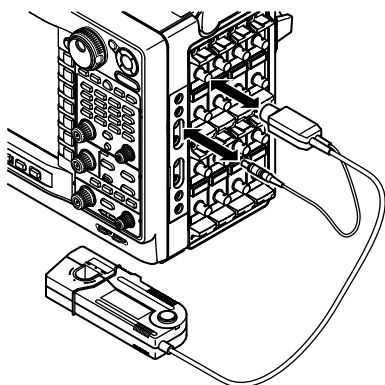

### CAUTION

Do not use the probe power supply terminals (optional) on the right side panel of the DL850/DL850V for purposes other than supplying power to the current probes. Also, be sure to use only the number of probes allowed. Otherwise, the DL850/DL850V or the devices connected to them may get damaged.

### 3.5 Connecting Probes

## Precautions to Be Taken When Using Current Probes

When connecting the current probe to the probe power supply terminal on the right side panel, make sure that the current does not exceed the range shown below. Otherwise, the DL850/DL850V operation may become unstable due to the activation of the excessive current protection circuit of the power supply.

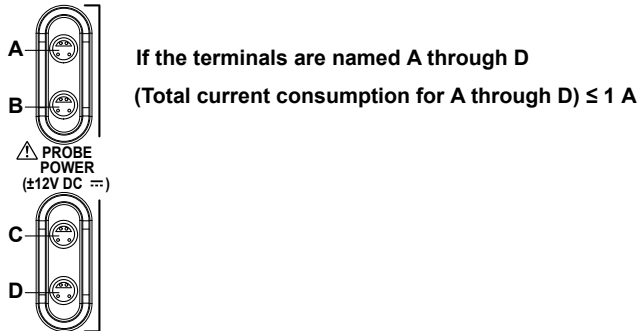

## Specifications of the Probe Power Supply Terminals (Optional)

Item	
Number of probes that can be used	4
Probes that can be used	Current probe (700937, 701930, 701931, and 701933)
Number of current probes that can be used	700937 (15 A): Up to 4 701930 (150 A): Up to 2 701931 (500 A): Up to 1 701933 (30 A): Up to 2
Supply voltage	$\pm 12$ V, two outputs (up to 1 A total current)

When using the current probe, the number of probes that can be used is limited by the current generated by the device under measurement (current measured by the current probe). The measured versus consumed current characteristics of current probes that can be connected to the instrument are indicated below.

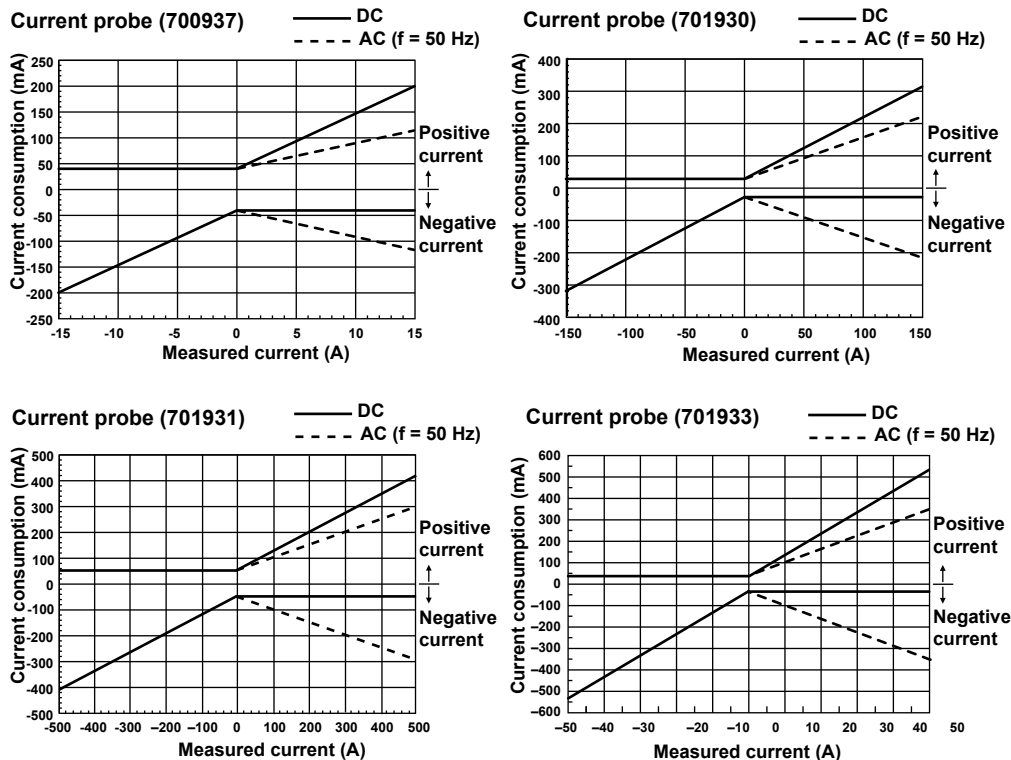

For details about each current probe, contact your nearest YOKOGAWA dealer.

## Connecting Differential Probes (700924)

When using differential probes (700924) made by YOKOGAWA, connect the BNC output connector to the input terminal of the oscilloscope. Also, be sure to connect the GND lead to the functional ground terminal of the DL850/DL850V. If necessary, use the auxiliary grounding lead extension. A measurement of 1400 V<sub>peak</sub> is possible by connecting the GND lead to the DL850/DL850V. For details on the connection procedure, see the manual that came with the differential probe.

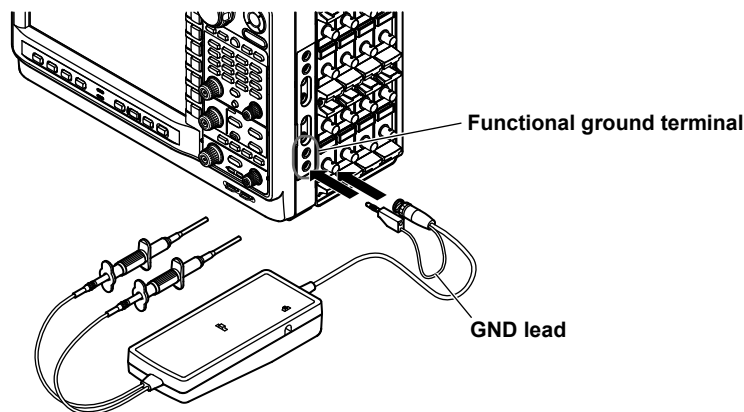

### WARNING

#### In Using the High Voltage Differential Probes

Be sure to connect the GND lead of a differential probe (the 700924 or 700925) to the functional ground terminal on the right side panel of the DL850/DL850V. Otherwise, high voltage may appear at the BNC connector making it dangerous. Also, be sure to connect the GND lead to the DL850/DL850V before you connect to the device under measurement.

## 3.6 Correcting the Probe Phase

For the following modules, always correct the probe phase before you use a probe for measurement.

- High-Speed 100 MS/s, 12-Bit Isolation Module: 720210 (HS100M12)
- High-Speed 10 MS/s, 12-Bit Isolation Module: 701250 (HS10M12)
- High-Speed High-Resolution 1 MS/s, 16-Bit Isolation Module: 701251 (HS1M16)
- High-Speed 10 MS/s, 12-Bit Non-Isolation Module: 701255 (NONISO\_10M12)
- High-Voltage 100 kS/s, 16-Bit Isolation Module (with RMS): 701260 (HV (with RMS))
- Acceleration/Voltage Module (with AAF): 701275 (ACCL/VOLT)
- Frequency Module: 701280 (FREQ)



### CAUTION

Do not apply external voltage to the probe compensation output terminal. This may cause damage to the internal circuitry.

1. Turn on the power switch.
2. Connect the probe to a signal input terminal (the terminal that you will actually apply the signal to measure to).
3. Connect the tip of the probe to the probe compensation output terminal on the front panel of the instrument, and connect the ground wire to the functional ground terminal.
4. Follow the instructions in section 4.5, “Performing Auto Setup,” to perform auto setup on the probe.
5. Insert a screwdriver into the phase adjustment knob, and turn the variable capacitor so that the displayed waveform is an appropriate square wave.

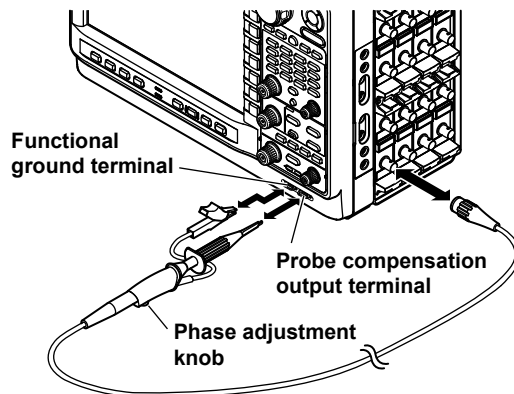

### Necessity of Phase Correction of the Probe

If the probe's input capacitance is not within the appropriate range, the gain will not be steady in relation to the frequency, and waveforms will not be displayed correctly. Also, because the input capacitance is not the same for each probe, the probe's have variable capacitors (trimmers) that need to be adjusted. This adjustment is referred to as phase correction.

Always correct the phase of a probe that you are using for the first time.

Also, because the appropriate input capacitance range is different for each channel, you need to perform phase correction when you change the channel that a probe is connected to.

## Phase Compensation Signal

The instrument generates the following square wave signal from the COMP signal output terminal.

Frequency: 1 kHz  $\pm$  1%

Computation: 1 V  $\pm$  10 %

## Differences in the Waveform due to the Phase Correction of the Probe

Correct waveform

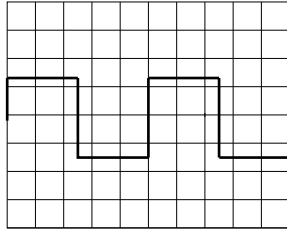

Too much adjustment  
(increased gain in the high  
frequency band)

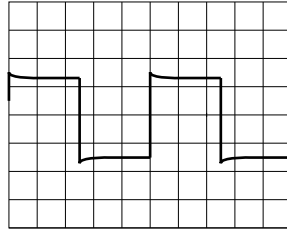

Not enough adjustment  
(reduced gain in the high  
frequency band)

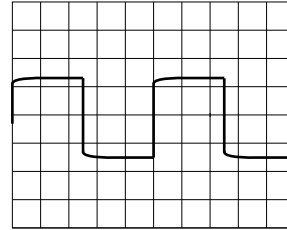

## Notes about Using Probes with the Frequency Module (701280 (FREQ))

You cannot perform phase correction on a probe connected to the frequency module. To use a probe with the frequency module, first perform phase correction on the probe using another module.

## 3.7 Connecting Measuring Leads

### Connecting Measuring Leads

When you measure voltage using the 701261 (UNIVERSAL), 701262 (UNIVERSAL (AAF)), or 701265 (TEMP/HPV), connect the measuring leads of a bipolar banana plug terminal like the one shown in the figure below to the input terminal (binding post terminal).

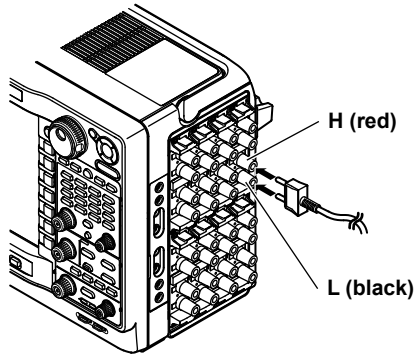

### WARNING

- When connecting a device under measurement to the instrument, be sure to turn off the device. It is extremely dangerous to connect or remove measuring leads while the device under measurement is on.
- To prevent the possibility of electric shock, always connect measuring leads that match the voltage range that you are measuring to the signal input terminals of the 701261 (UNIVERSAL), 701262 (UNIVERSAL (AAF)), and 701265 (TEMP/HPV).
- Applying a voltage exceeding the value indicated below may damage the input section. If the frequency is above 1 kHz, damage may occur even when the voltage is below this value.

For 701261, 701262, or 701265

- Maximum input voltage (across the input terminals, H and L,<sup>1</sup> at a frequency of 1 kHz or less)  
42 V (DC+AC<sub>peak</sub>)
- Maximum allowable common mode voltage (across the input terminals, H or L, and earth,<sup>2</sup> at a frequency of 1 kHz or less)  
42 V (DC + AC<sub>peak</sub>, CAT I and CAT II, 30 V<sub>rms</sub>)
- Do not connect a plug-in type terminal with exposed conducting parts to the input terminal to be used as a measuring lead. It is very dangerous, if the connector comes loose.

Input terminal of the  
701261, 701262,  
and 701265

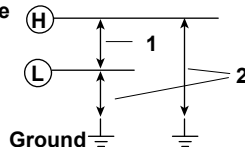

## 3.8 Connecting Thermocouples

### Connecting Thermocouples

If you are connecting the compensation lead of the thermocouple to the input terminal (binding post terminal) of the 701261 (UNIVERSAL), 701262 (UNIVERSAL (AAF)), or 701265 (TEMP/HPV), loosen the terminal knob, pass the lead through the terminal, and tighten the knob.

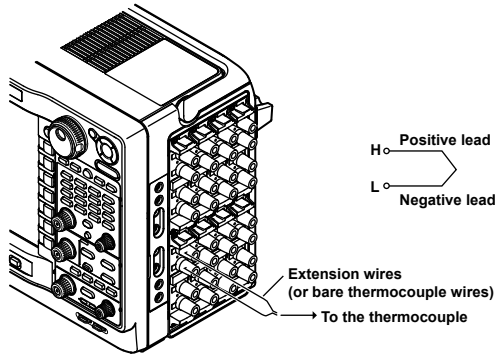

### CAUTION

- The 701261 (UNIVERSAL), 701262 (UNIVERSAL (AAF)), or 701265 (TEMP/HPV) is isolated from the DL850/DL850V. However, applying a voltage exceeding the value below may damage the input section. If the frequency is above 1 kHz, damage may occur even when the voltage is below this value.  
Maximum input voltage (across the input terminals, H and L, at a frequency of 1 kHz or less)  
42 V (DC + ACpeak)  
Maximum allowable common mode voltage (across the input terminal L and earth at a frequency of 1 kHz or less)  
42 V (DC + ACpeak, CAT I and CAT II, 30 Vrms)
- Correct measurements cannot be obtained when the positive and negative thermocouple leads are connected in reverse.
- Immediately after connecting the thermocouple, the heat balance may be disturbed at the input terminal section and may cause measurement errors. Therefore, wait about ten minutes before making a measurement.
- In an environment where the air from the air conditioning is directly applied to the input terminals or where there are effects from a heat source, the heat balance may be disturbed at the input terminal section and cause measurement errors.  
When making measurements in this type of environment, take preventive measures such as changing the position.

## 3.9 Connecting Bridgeheads

Strain is measured by connecting a strain gauge bridge (bridge head) or a strain gauge transducer to the strain module.

This section will mainly describe the procedures and precautions related to the connection of the bridge head (Model 701955/701956/701957/701958). For the connection of other strain gauge bridges or strain gauge transducers, see the respective manuals.

### CAUTION

Only connect a strain gauge bridge (bridge head) or a strain gauge transducer to the strain module. Connecting other devices or applying a voltage that exceeds the values indicated below to the strain module may damage the input section.

- Maximum input voltage (between Input+ and Input–)  
10 V (DC + ACpeak)
- Maximum allowable common mode voltage (between each terminal and earth ground)  
42 V (DC + ACpeak, CAT I and CAT II, 30 Vrms)

### Connecting the Strain Gauge

The bridge head (701955/701956/701957/701958) supports six types of connection methods: single-gauge method, single-gauge three-wire method, adjacent-side two-gauge method, opposite-side two-gauge method, opposite-side two-gauge three-wire method, and four-gauge method. For details, see the manual that came with the bridge head (701955/701956/701957/701958).

If you are using a strain gauge bridge or a strain gauge transducer other than the bridge head (701955/701956/701957/701958), see the respective manuals.

### Connecting the Strain Module and the Bridge Head

#### When Using the Strain Module (701270) and the Bridge Head (701955/701956)

Using the cable that came with the bridge head (701955/701956), connect the Strain Module (701270) and the bridge head.

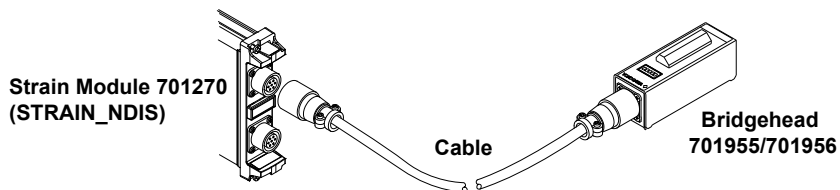

#### When Using the Strain Module (701271) and the Bridge Head (701957/701958)

Using the cable that came with the bridge head (701957/701958), connect the Strain Module (701271) and the bridge head.

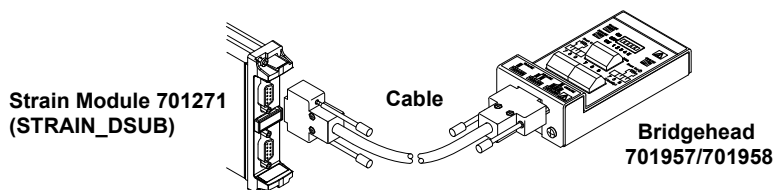



**When Using a Bridge Head with a MIL Standard (MIL-C-26482) Connector Wiring**

The connector on the Strain Module (701270) is a NDIS connector.\* Use a connector adapter cable (700935) by YOKOGAWA to make a MIL-NDIS conversion and connect to the Strain Module (701270).

\* Connector recommended by JSNDI (Japanese Society for Non-Destructive Inspection)

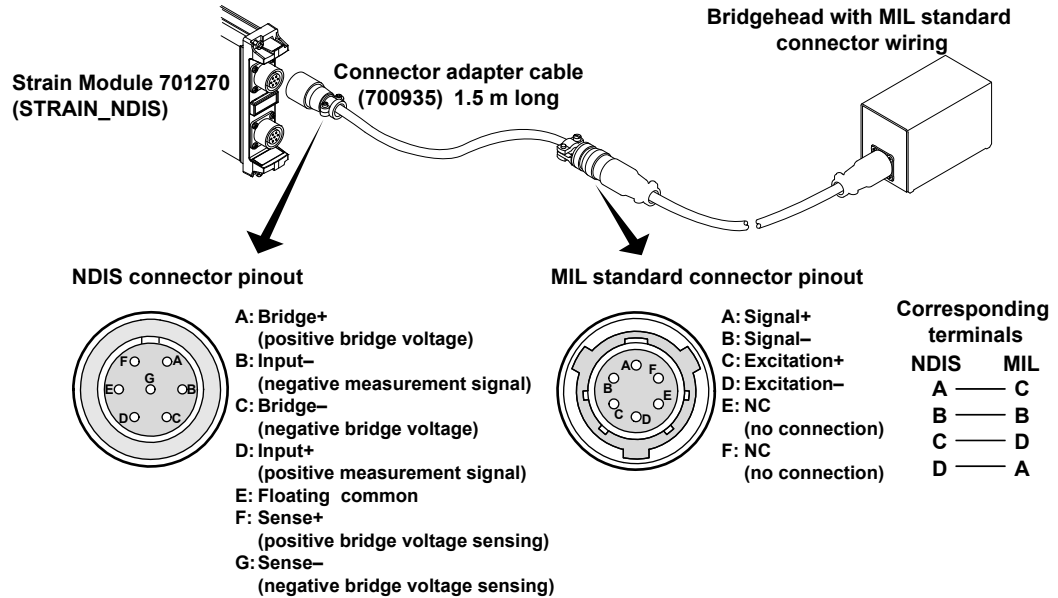

**When Using the A1002JC Connector by YOKOGAWA**

You can create your own cable by using the YOKOGAWA A1002JC connector that is compatible with the strain module and use the cable to connect a strain gauge bridge or a strain gage transducer to the strain module.

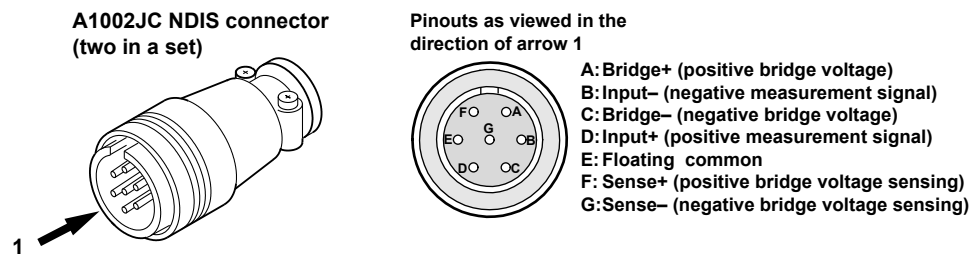

**Note**

- The connector shell is connected to the case potential of the DL850/DL850V.
- Each of the signals from A to G is isolated within the module.
- When creating your own cable, we recommend that you use a shielded cable in order to shut out external noise.



**CAUTION**

Take extra care when wiring the connectors. If the wiring is shorted or incorrect, it can damage the DL850/DL850V or other instruments that are connected to the DL850/DL850V.

### 3.9 Connecting Bridgeheads

#### Pinout of the D-Sub Connector

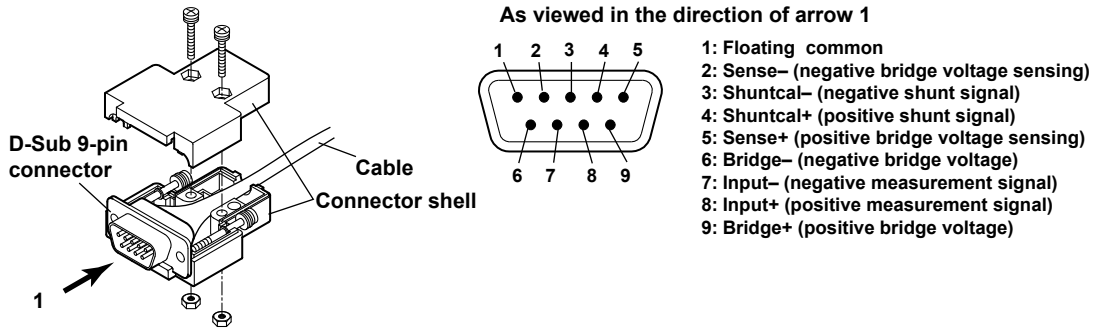

## 3.10 Connecting a Logic Probe to the Logic Input Module

To measure logic signals, connect a logic probe (the 702911, 702912, 700986, or 700987) to a logic input module (the 720230).



### CAUTION

- Applying a voltage greater than the limits listed below may damage the logic probe or the instrument. For frequencies above 1 kHz, damage may occur even if the voltage is less than the limits listed below.  
Maximum input voltage (at a frequency of 1 kHz or less)
  - Logic probes 702911 and 702912: 35 V
  - High-speed logic probe 700986: 42 V (DC + ACpeak)
  - 700987 isolated logic probe: 250 Vrms (however, ACpeak must be less than 350 V, and DC must be less than 250 V)
- For logic probes 702911 and 702912 and high-speed logic probe 700986, the eight input lines of a single pod share the same ground. Also, the instrument's ground and the grounds of each pod are connected. Do not apply signals with different common voltages to each input line. Doing so may damage the instrument, connected logic probes, and connected devices.
- The input terminals of an isolated logic probe are isolated from each other and from the DL850/DL850V.
- Turn off the DL850/DL850V before you connect or remove a 26-pin connector from the logic signal input connector.
- Do not stack the isolated logic probes during use. Also, allow enough space around the probes to avoid a temperature increase inside the probes.
- Do not use the YOKOGAWA 700985 logic probe with the DL850/DL850V. The 700985 is shaped so that it can be connected to the logic signal input connector of the DL850/DL850V, but it is not electrically compatible with the DL850/DL850V, so connecting the two could damage the DL850/DL850V or the 700985.

## About the Logic Probe

### Types of Logic Probes

YOKOGAWA provides the following four types of probes (as accessories) for connecting to the logic signal input connector of the DL850/DL850V.

- High-Speed Logic Probe (700986)
- Isolated Logic Probe (700987)
- 1 m Logic Probe (702911)
- 3 m Logic Probe (702912)

### Types of Measuring Leads That Can Be Used

Use the following leads to connect to the point of measurement.

#### Connecting Leads That Can Be Used with Logic Probes 702911, 702912, and 700986

The following two types are available.

- Connecting lead (alligator clip, parts No. B9879PX)  
This lead is primarily for connecting to contact circuits. The lead consists of 8 signal lines (red) and 8 earth lines (black).
- Connecting lead (IC clip, parts No. B9879KX)  
This lead is primarily for connecting to electronic circuits. The lead consists of 8 signal lines (red) and 2 earth lines (black).

### 3.10 Connecting Logic Probes

#### Types of Measuring Leads That Can Be Used on the Isolated Logic Probe (700987)

Use the following measuring lead.

- For measuring voltages of 42 V or more: Measuring lead for isolation logic (758917)  
An alligator adapter (758922), alligator adapter (758929), or alligator clip (dolphin type, 701954) is needed to make measurements.

#### Note

Do not modify the connecting leads. Doing so may degrade their specifications.

## Connecting Logic Probes

#### Connecting Logic Probes 702911, 702912, and 700986

1. Attach the connecting lead (IC clip or alligator clip) that came with the logic probe, and push the logic probe levers inwards to lock the connector into place. To remove the connecting leads from the logic probe, push both of the levers outwards. Proceed to step 3.

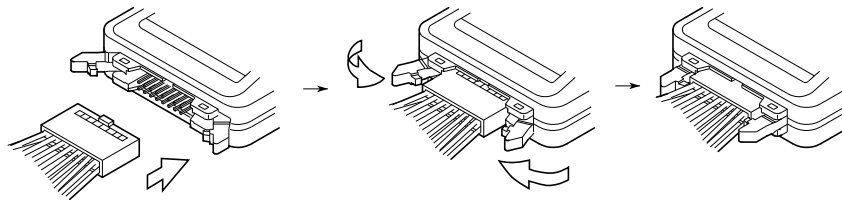

#### Connecting the Isolated Logic Probe (700987)

1. Connect the measuring leads to the logic probe's input terminal.
2. Set the input switch. When you set it to AC, the threshold levels are 50 VAC  $\pm$  50% (Hi: 80 to 250 VAC, Lo: 0 to 20 VAC); when you set it to DC, the threshold levels are 6 V  $\pm$  50% (Hi: 10 to 250 VDC, Lo: 0 to 3 VDC).

#### Connecting the Logic Probe to a Logic Input Module

3. Turn the instrument's power switch off.
4. Connect to the logic signal input connector of the logic input module (720230) the end of the logic probe's 26-pin connector that has a clamp filter (ferrite core; part number: A1190MN).
5. Turn on the DL850/DL850V.

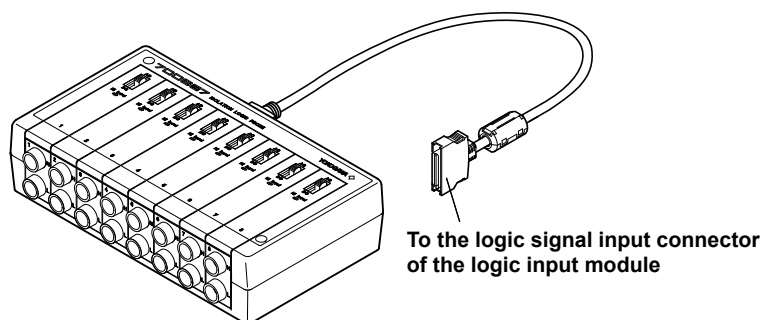

#### Note

- When a logic probe is not connected to the DL850/DL850V, each bit is indicated as being at the high level.
- For the logic probe specifications, see section 6.14, "Logic Probe Specifications."
- The logic input display is turned off by default. For information about turning the display on and off, see chapter 1, "Vertical and Horizontal Control," in the user's manual.

## 3.11 Connecting an Acceleration Sensor

An acceleration sensor is connected when measuring acceleration on the 701275 (ACCL/VOLT). For a details on acceleration sensors, see the respective manuals.



### CAUTION

- Applying a voltage that exceeds the values indicated below to the 701275 (ACCL/VOLT) may damage the input section.  
Maximum input voltage: 42 V (DC+ACpeak)
- When connecting acceleration sensors, do it without the bias current being supplied to the sensor. Otherwise, damage to the internal circuitry of the acceleration sensors may result.
- The DL850/DL850V only supports acceleration sensors that are driven by constant current with driving current of 4 mA and driving voltage of 22 V.

## Connecting Acceleration Sensors

### When Connecting Built-in Amplifier Type Acceleration Sensors

The DL850/DL850V allows built-in amplifier type (low impedance) acceleration sensors to be directly connected. To connect built-in amplifier type acceleration sensors, use BNC cables. Use cables that are appropriate for the acceleration sensors being used.

Connect the acceleration sensors with the bias current turned off. After connection, turn on the supply current to the acceleration sensors for making measurements.

### When Connecting Charge Output Type Acceleration Sensors

Since the charge output type (high impedance) acceleration sensors do not have built-in amplifier circuit, they cannot be directly connected to the DL850/DL850V. Use either of the following two methods to connect the sensors.

#### Using the Charge Amplifier

Connect a charge-output-type acceleration sensor to the charge amplifier using a high-insulation, low-noise cable. The acceleration signal (charge signal) that has been converted to a voltage signal by the charge amplifier is input to the DL850/DL850V using a normal coaxial cable. The DL850/DL850V measures the signal in the voltage measurement mode. The measured data can be converted to acceleration values using the scale conversion function of the DL850/DL850V.

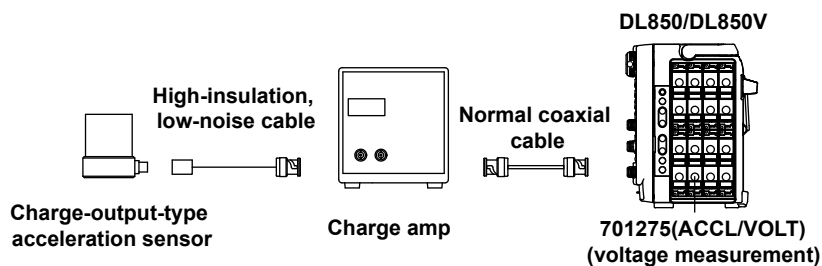

### 3.11 Connecting an Acceleration Sensor

---

#### When using the charge converter

Connect a charge-output-type acceleration sensor to the charge converter using a high-insulation, low-noise cable. By driving the charge converter using a constant current from the DL850/DL850V, voltage signals similar to those of the built-in amplifier type acceleration sensor can be obtained. The DL850/DL850V measures the signals in the acceleration measurement mode and supplies bias current to the charge converter. Set the input sensitivity of the DL850/DL850V according to the charge converter gain and the sensitivity of the charge output type acceleration sensor. The DL850/DL850V only supports charge converters that are driven by constant current with driving current of 4 mA and driving voltage of 22 V.

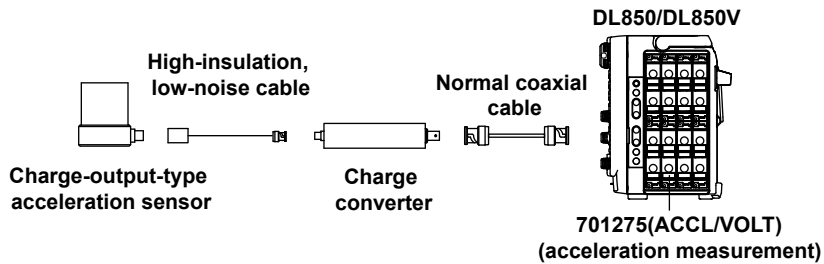

#### Note

The unit of measurement of acceleration on the DL850/DL850V is  $m/s^2$ . If the sensitivity is indicated in  $mV/G$  for the acceleration sensor that you are using, convert it to  $m/s^2$ . ( $1 G = 9.81 m/s^2$ )

---

#### Precautions

- Do not apply shock outside the specifications (see the manual for the acceleration sensor) to the acceleration sensors. Doing so can damage the sensors.
- Do not impose drastic temperature changes on the acceleration sensors. Temperature changes may affect the output value of the acceleration sensors.
- By default, the bias current on the acceleration sensors is turned off. Be sure to turn it on before using the acceleration sensors. Bias current is valid only when measuring acceleration. When measuring other parameters, it is automatically turned off. The bias current on/off setting is saved when the DL850/DL850V is turned off.

## 3.12 Connecting Sensors to the Frequency Module

### Sensors and Signal Output Sources That Can Be Connected

The table below shows the sensor and signal output source that can be connected. Appropriate input presets are provided for each sensor and signal output source. For information about presets, see Input Setup in section 1.6, “Configuring Frequency, Revolution, Period, Duty Cycle, Power Supply Frequency, Pulse Width, Pulse Integration, and Velocity Measurements,” in the user’s manual.

Sensor and Signal Output Source	Preset Name
5-V logic signal, 5-V output sensor, and sensor with TTL output	Logic 5V
3-V logic signal and 3-V output sensor	Logic 3V
12-V driven relay/sequence circuit and 12-V driven sensor	Logic 12V
24-V driven relay/sequence circuit and 24-V driven sensor	Logic 24V
Sensor/Encoder that outputs positive and negative voltages and sensor that outputs sine waves	ZeroCross
100-VAC power supply (connected via the isolated probe (700929))	AC100V
200-VAC power supply (connected via the isolated probe (700929))	AC200V
Power-generating electromagnetic pickup	EM Pickup
Open collector (0 to 5 V) output sensor, contact output	Pull-up 5V*

\* For the internal equivalent circuit when the preset setting is Pull-up 5V, see the “Frequency Measurement” section in chapter 2, “Vertical Axis” in the feature’s guide (IM DL850-01EN).

### Precautions to Be Taken When Connecting to Sensors or Signal Output Sources



#### CAUTION

- The maximum input voltage for direct input is indicated below. Applying a voltage exceeding this value can damage the input section. When applying a high voltage of 42 V or more, be sure to use an isolated probe (the 700929 or 701947).  
Maximum input voltage: 42 V (DC + ACpeak) (CAT I and CAT II)
- The minimum input voltage is 0.2 Vpp. At voltage amplitude less than 0.2 Vpp, the measured values may be unstable.
- Attach/Remove the sensors after confirming that the rotating object to be measured is stopped.
- Set the preset to electromagnetic pickup (EM Pickup) only when using the electromagnetic pickup.

### Connecting the Electromagnetic Pickup

- The DL850/DL850V allows power-generating electromagnetic pickup to be connected directly. The DL850/DL850V does not support electromagnetic pickups that require external power supply or those that require a terminator at the output.
- To connect electromagnetic pickups, use BNC cables. Use cables that are appropriate for the electromagnetic pickups being used.
- When the input is set to electromagnetic pickup, determination is not made on whether the input voltage level exceeds the specified input voltage range. Therefore, the LEDs (see page 3-7) do not illuminate even when the input voltage level is over range.

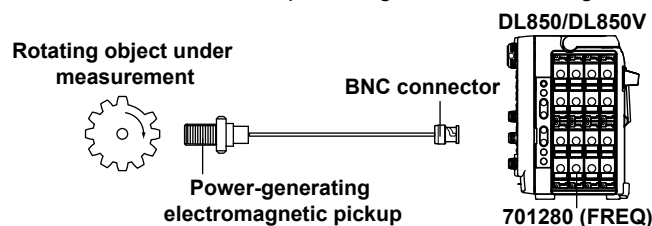

## 3.13 Connecting Wires to the 16-CH Voltage Input Module

To measure voltages with the 720220 (16CH VOLT), connect wires to the terminal block.



### WARNING

- When connecting a device under measurement to the instrument, be sure to turn off the device. It is extremely dangerous to connect or remove wires while the device under measurement is on.

#### Precautions to Be Taken When Using the Modules

- Do not apply input voltage exceeding the maximum input voltage, withstand voltage, or allowable surge voltage.
- To avoid electric shock, be sure to ground the instrument.
- To prevent the possibility of electric shock, be sure to fasten the module screws. Otherwise, the electrical protection function and the mechanical protection function will not be activated.
- Do not leave the instrument connected to devices in an environment that may be subject to voltage surges.
- To prevent electric shock, connect wires to the terminal block that match the voltage range that you are measuring.
- Applying a voltage exceeding the value indicated below may damage the input section. If the frequency is above 1 kHz, damage may occur even when the voltage is below this value.

Maximum input voltage (across the input terminals, H and L,<sup>1</sup> at a frequency of 1 kHz or less)

42 V (DC + AC<sub>peak</sub>)

Maximum allowable common mode voltage (across the input terminals, H or L, and earth,<sup>2</sup> at a frequency of 1 kHz or less)

42 V (DC + AC<sub>peak</sub>, CAT I and CAT II, 30 V<sub>rms</sub>)

- Wire the L input terminals for all of the sub channels on the same module to the same potential. The L input terminals of the sub channels are all common. Because the L input terminals are electrically connected inside the DL850/DL850V, connecting different potentials to them could result in short circuiting and damage to the 16-CH Voltage Input Module.

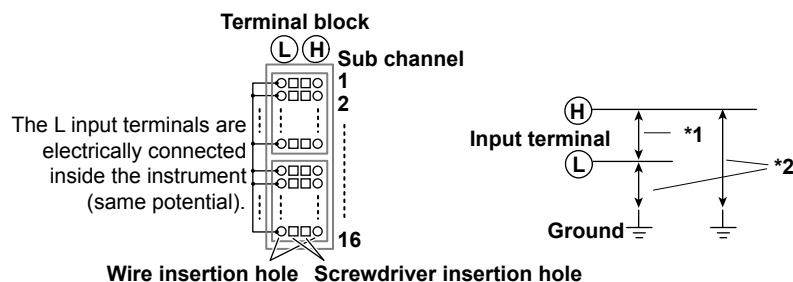

- When you release or lock the terminal block release levers, be careful not to injure yourself on the levers' protrusions.

### CAUTION

When you attach the terminal block, if you try to attach it upside down, you may damage the terminal block and the module. Check the vertical orientation of the block before you install it.



## What to Prepare

### Wiring

Remove approximately 7 mm of the insulation from the ends of the wires.

Electrical wire: 0.20 mm<sup>2</sup> to 1.00 mm<sup>2</sup> recommended (solid wire or thin stranded wire). AWG size: 24-18.

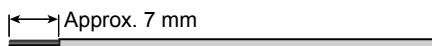

### Flat-blade Screwdriver

Tip size: 0.4 mm (thickness) × 2.5 mm (width)

Shape: DIN5264-A (Use a straight driver.)

## Connecting Wires to the Terminal Block

First, turn off the DL850/DL850V. Make sure that the other end of the wire that you are connecting to the terminal block is not connected to the device under measurement, or make sure that the device under measurement that you are going to connect to is turned off.

1. Insert the flat-blade screwdriver into the screwdriver insertion hole right next to the wire insertion hole.  
If you do not insert the flat-blade screwdriver into the hole firmly, the wire insertion hole will not open.
2. Insert the wire that you prepared into the wire insertion hole.  
Insert the wire until it reaches the back of the wire insertion hole.
3. Pull the flat-blade screwdriver out of the screwdriver insertion hole.  
When you pull out the flat-blade screwdriver, hold the wire in place so that it does not come out with the screwdriver.
4. Pull lightly on the wire to make sure that it doesn't come out.

After you have finished connecting the wires, turn on the DL850/DL850V and the device under measurement.

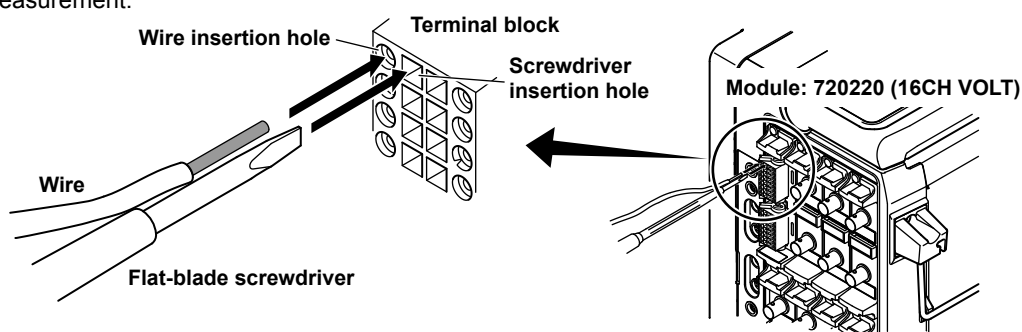

### Note

#### Removing and Attaching the Terminal Block

It is normally not necessary to remove the terminal block, but it is possible to do so.

#### Removal

Push terminal block release levers 1 and 2 to their release positions, and pull out the terminal block.

#### Attachment

Push terminal block release levers 1 and 2 to their lock positions, and insert the terminal block. Push the terminal block firmly all the way to the back. However, the terminal block will not go all the way to the back if it is upside down. Do not try to force the terminal block all the way to the back.

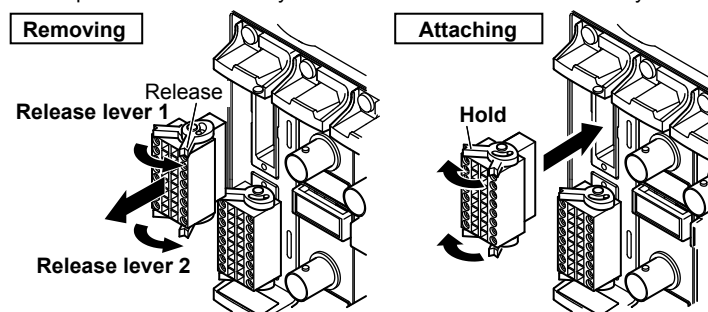

## 3.14 Connecting a Cable to the CAN Bus Monitor Module

To monitor CAN bus signals, connect a cable to the CAN bus monitor module's D-sub connector.

### Connector Pinout

The pinout of the D-sub connector (9 pin, male) is shown below.

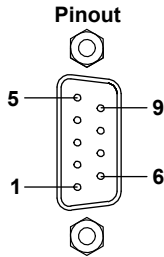

Pin No.	Signal	Function
1	(NC)	Not used (can not be connected to)
2	CAN_L	CAN low signal
3	GND	Ground
4	(NC)	Not used (can not be connected to)
5	(NC)	Not used (can not be connected to)
6	GND	Ground
7	CAN_H	CAN high signal
8	(NC)	Not used (can not be connected to)
9	(NC)	Not used (can not be connected to)

\* One-inch screws (number 4-40 UNC) are used.

### Note

The connector shell is connected to GND. Additionally, GND and the connector shell are isolated from the electric potential of the DL850/DL850V case (earth).



### CAUTION

Applying a voltage greater than the maximum input voltage may damage the input section.

### Connecting the Cable (Signal wires)

When you connect a cable to the D-sub connector, be sure to tighten the screws to ensure that the cable is connected securely.

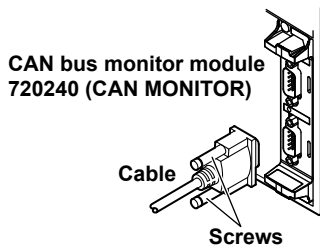

## 3.15 Attaching the Panel Sheet

Depending on the suffix code, attach the supplied front panel sheet if necessary. You can attach the panel sheet over the panel sheet that was attached when the DL850/DL850V was shipped from the factory.

### Attaching the Panel Sheet

There are three panel sheet attachment hooks on both the left and right sides of the front panel. Hook the panel sheet onto the three hooks on the left side. Then, bend the panel sheet slightly, and hook it onto the three hooks on the right side.

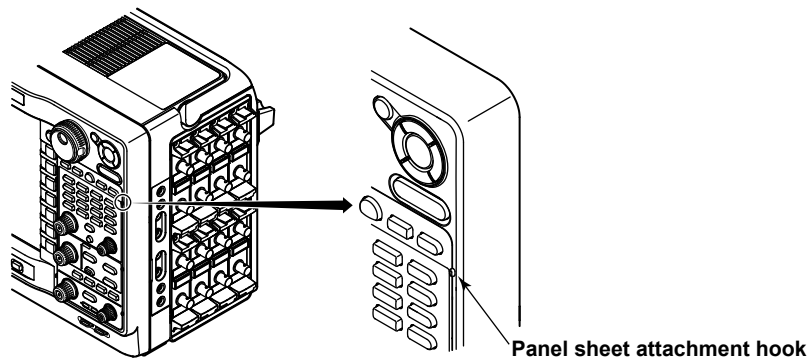

## 4.1 Key and Jog Shuttle Operations

### Key Operations

#### How to Use Setup Menus That Appear When Keys Are Pressed

The operation after you press a key varies depending on the key that you press.

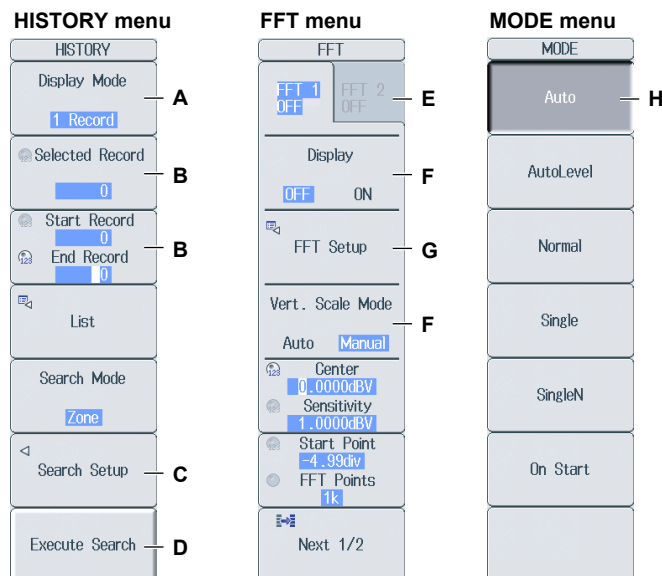

A: Press the soft key to display a selection menu.

Press the soft key that corresponds to the appropriate setting.

B: Press the soft key to use the jog shuttle to configure this setting. Use the jog shuttle or the arrow keys to set the value or select an item.

To set a value, press NUM LOCK, and then use the CH1 to CH16 keys.

C: A related setup menu appears when you press the soft key.

D: Press the soft key to execute the specified feature.

E: Selects which item to configure when configuring a feature that consists of two items that operate with different settings, such as the FFT1 and FFT2 features.

F: The selected setting switches each time you press the soft key.

G: Displays a dialog box or a keyboard.

Use the jog shuttle, SET key, and arrow keys to configure the settings in the dialog box or operate the keyboard.

H: Pressing a key sets the item to the setting that corresponds to that key.

#### How to Display the Setup Menus That Are Written in Purple below the Keys

In the explanations in this manual, "SHIFT+key name (written in purple)" is used to indicate the following operation.

1. Press **SHIFT**. The SHIFT key illuminates to indicate that the keys are shifted.

Now you can select the setup menus written in purple below the keys.

2. Press the key that you want to display the setup menu of.

#### ESC Key Operation

If you press the ESC key when a setup menu or available settings are displayed, the screen returns to the menu level above the current one. If you press the ESC key when the highest level menu is displayed, the setup menu disappears.

## 4.1 Key and Jog Shuttle Operations

### RESET Key Operation

If you press RESET when you are using the jog shuttle to set a value or select an item, the setting is reset to its default value (depending on the operating state of the DL850/DL850V, the setting may not be reset).

### SET Key Operations

The operation varies as indicated below depending on what you are setting.

- For a soft key menu that has two values that you use the jog shuttle to adjust  
Press SET to switch the value that the jog shuttle adjusts.
- For a menu that has the jog shuttle + SET mark (⊖+SET) displayed on it.  
Press SET to confirm the selected item.

### Arrow Key Operations

The operation varies depending on what you are setting.

- When setting a value  
Up and down arrow keys: Increases and decreases the value  
Left and right arrow keys: Changes which digit to set
- When selecting the item to set  
You can use the up and down arrow keys.

## How to Enter Values in Setup Dialog Boxes

1. Use the keys to display the appropriate setup dialog box.
2. Use the jog shuttle or the arrow keys to move the cursor to the setting that you want to set.
3. Press **SET**. The operation varies as indicated below depending on what you are setting.
  - A selection menu appears.
  - A check box is selected or cleared.
  - An item is selected.
  - A table of settings is selected.

### Displaying a Selection Menu and Selecting an Item

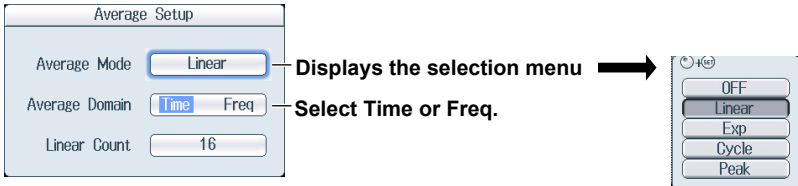

Displays the selection menu →

Select Time or Freq.

After selecting an item with the jog shuttle, press SET to confirm it.

### Setting Items in a Table

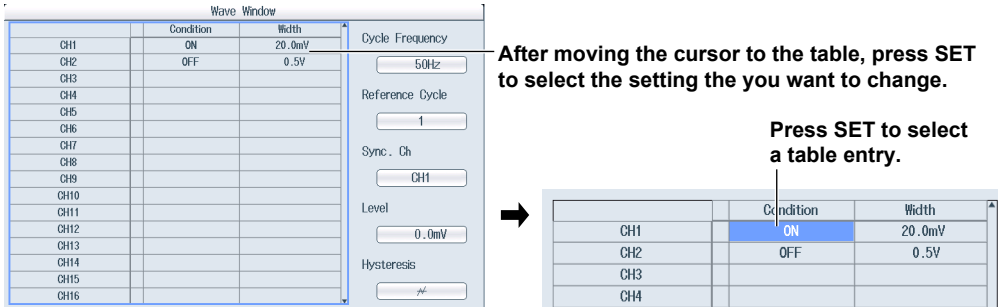

After moving the cursor to the table, press SET to select the setting you want to change.

Press SET to select a table entry.

### How to Clear Setup Dialog Boxes

Press **ESC** to clear the setup dialog box from the screen.

## 4.2 Entering Values and Strings

### Entering Values

#### Using Dedicated Knobs

You can use the following dedicated knobs to enter values directly.

- Vertical POSITION knob
- SCALE knob
- TIME/DIV knob
- ZOOM magnification knob (MAG)
- Zoom POSITION knob (for scrolling zoom waveforms)

#### Using the Jog Shuttle

Select the appropriate item using the soft keys, and change the value using the jog shuttle, the SET key, and the arrow keys. This manual sometimes describes this operation simply as “using the jog shuttle.”

#### Using the Keypad

Press **NUM LOCK** to illuminate the NUM LOCK key, and use the **CH1** to **CH16** keys to enter a value. After you enter the value, press **ENTER** to confirm it.

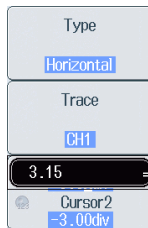

Use the keypad to enter the value.

#### Note

Some items that you can set using the jog shuttle are reset to their default values when you press the RESET key.

## Entering Character Strings

Use the keyboard that appears on the screen to enter file names and comments. Use the jog shuttle, the SET key, and the arrow keys to operate the keyboard and enter a character string.

### How to Operate the Keyboard

1. Press the **InputMode** soft key and then the **English** soft key.
2. After bringing up the keyboard, use the jog shuttle to move the cursor to the character that you want to enter. You can also move the cursor using the up, down, left, and right arrow keys.
3. Press SET to enter the character.
  - If a character string has already been entered, use the arrow soft keys (< and >) to move the cursor to the position you want to insert characters into.
  - To switch between uppercase and lowercase letters, press the **Caps** soft key.
  - To delete the previous character, press the **BS** soft key.
4. Repeat steps 1 and 3 to enter all of the characters in the string.
 

Select  on the keyboard or press the **History** soft key to display a list of character strings that you have entered previously.

Use the jog shuttle to select a character string, and press **SET** to enter the selected character string.
5. Press the **ENTER** soft key, or move the cursor to ENTER on the keyboard, and press **SET** to confirm the character string and clear the keyboard.

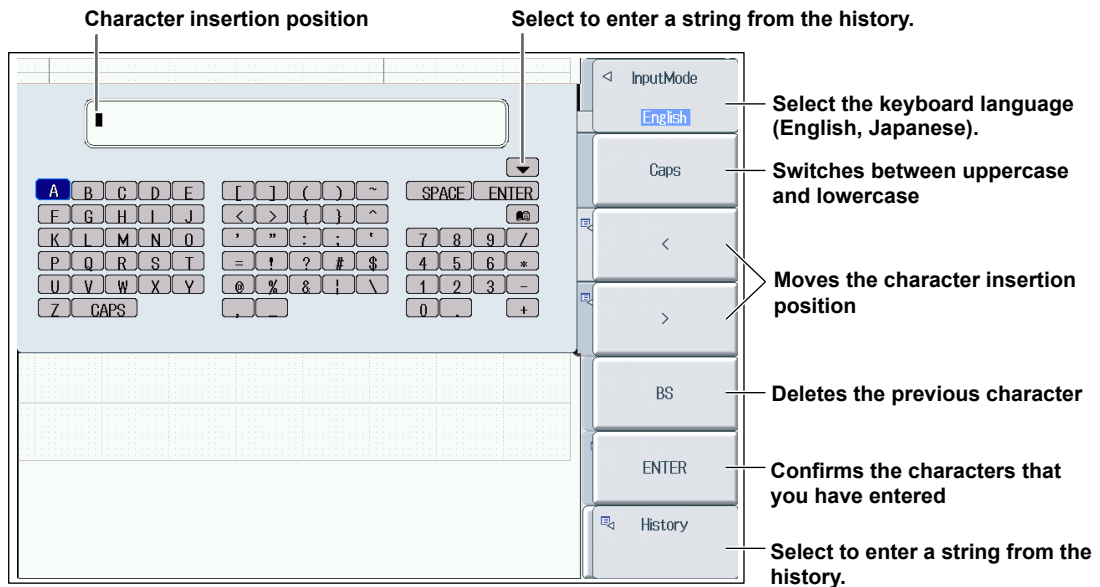

#### List of previously entered strings

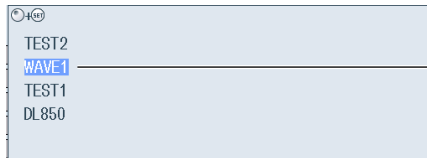

After selecting an item using the jog shuttle or the arrow keys, press SET to confirm it.

#### Note

- @ cannot be entered consecutively.
- File names are not case-sensitive. Comments are case-sensitive. The following file names cannot be used due to MS-DOS limitations:  
AUX, CON, PRN, NUL, CLOCK, COM1 to COM9, and LPT1 to LPT9

## 4.3 Using USB Keyboards and Mouse Devices

### Connecting a USB Keyboard

You can connect a USB keyboard and use it to enter file names, comments, and other items.

#### Usable Keyboards

You can use the following keyboards that conform to USB Human Interface Devices (HID) Class Ver. 1.1.

- When the USB keyboard language is English: 104 keyboards
- When the USB keyboard language is Japanese: 109 keyboards

#### Note

- Do not connect incompatible keyboards.
- The operation of USB keyboards that have USB hubs or mouse connectors is not guaranteed.
- For USB keyboards that have been tested for compatibility, contact your nearest YOKOGAWA dealer.

#### USB Ports for Peripherals

Connect a USB keyboard to the USB port for peripherals on the left side panel.

#### Connection Procedure

Connect a USB keyboard directly to the DL850/DL850V using a USB cable. You can connect or remove the USB cable regardless of whether the DL850/DL850V power switch is turned on (hot-plug support). Connect the type A connector of the USB cable to the DL850/DL850V, and connect the type B connector to the keyboard. When the power switch is on, the keyboard is detected and enabled approximately 6 seconds after it is connected.

#### Note

- Only connect a compatible USB keyboard, mouse, printer, or storage device to the USB port for peripherals.
- Do not connect multiple keyboards. You can connect one keyboard, one mouse, and one printer to the DL850/DL850V.
- Do not connect and disconnect multiple USB devices repetitively. Wait for at least 10 seconds after you connect or remove one USB device before you connect or remove another USB device.
- Do not remove USB cables during the time from when the DL850/DL850V is turned on until key operation becomes available (approximately 20 to 30 seconds).

#### Entering File Names, Comments, and Other Items

When a keyboard is displayed on the screen, you can enter file names, comments, and other items using the USB keyboard.

#### Entering Values from a USB Keyboard

You can use a USB keyboard to enter the values of items with  marks on the menu screens by pressing CTRL+N on the USB keyboard to put the DL850/DL850V in the NUM LOCK state.



### Using a USB Mouse

You can connect a USB mouse and use it to perform the same operations that you can perform with the DL850/DL850V keys. Also, by clicking a menu item, you can perform the same operation that you can perform by pressing the menu item's soft key or selecting the menu item and pressing the SET key.

#### USB Ports for Peripherals

Connect a USB mouse to a USB port for peripherals on the front or rear panel of the DL850/DL850V.

#### Usable USB Mouse Devices

You can use mouse devices (with wheels) that are compliant with USB HID Class Version 1.1.

#### Note

---

- For USB mouse devices that have been tested for compatibility, contact your nearest YOKOGAWA dealer.
  - Some settings cannot be configured by a mouse without a wheel.
- 

#### Connection Procedure

To connect a USB mouse to the DL850/DL850V, use one of the USB ports for peripherals. You can connect or disconnect the USB mouse at any time regardless of whether the DL850/DL850V is on or off (hot-plugging is supported). When the power switch is on, the mouse is detected approximately 6 seconds after it is connected, and the mouse pointer (🖱️) appears.

#### Note

---

- Only connect a compatible USB keyboard, mouse, printer, or storage device to the USB port for peripherals.
  - Even though there are two USB ports for peripherals, do not connect two mouse devices to the DL850/DL850V.
-

## Operating the DL850/DL850V Using a USB Mouse

- **Operations That Correspond to the Front Panel Keys (Top Menu)**

### Displaying the Top Menu

Right-click on the display. A menu of the DL850/DL850V front panel keys appears.

### Selecting an Item from the Top Menu

Click on the item that you want to select. A setup menu that corresponds to the item that you selected appears at the bottom of the display. The top menu disappears.

To display an item's submenu, point to the item. To select an item on a submenu, click on it, just as you would to select an item on the top menu.

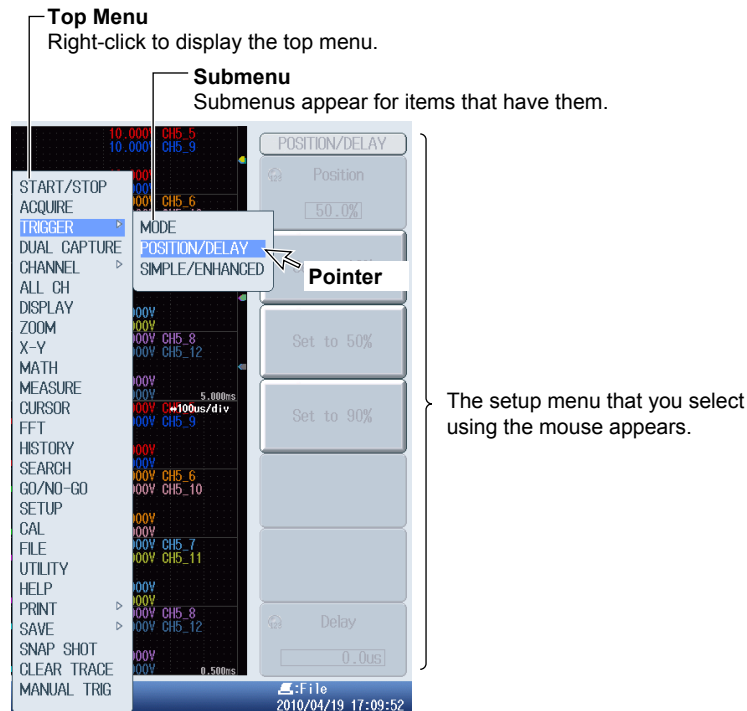

### Note

- The following keys are not displayed in the top menu:  
ESC, RESET, and SET

### 4.3 Using USB Keyboards and Mouse Devices

- **Setup Menu Operations (Same as soft key operations)**

#### Selecting a Setup Menu Item

Click the setup menu item that you want to select.

If a selection menu appears after you select an item, click the selection menu item that you want to choose.

If an item such as ON or OFF appears, click on the item to change its setting.

For menu items that are usually selected using the jog shuttle and the SET key, clicking on the item that you want to select will confirm your selection and close the dialog box.

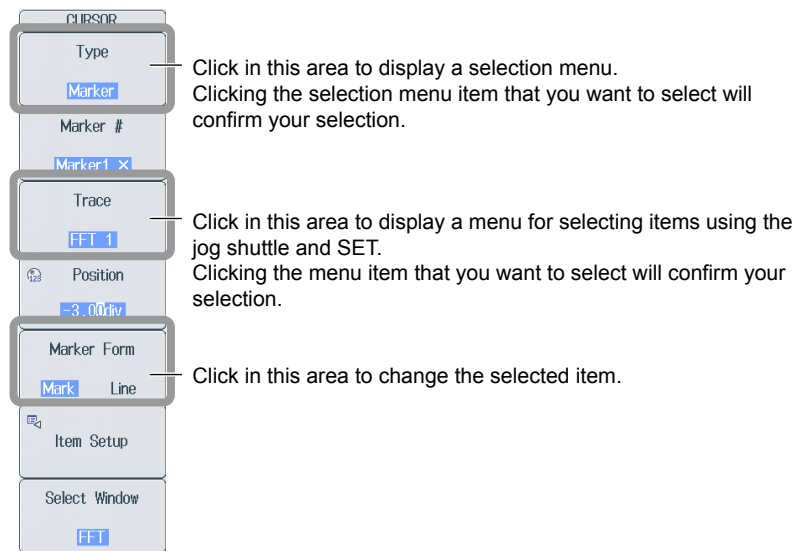





#### Clearing the Menu

To clear the menu, click outside of it.

- **Specifying Values**

The following description explains how to specify values for menu items that have a  icon next to them.

- If there are two  icons next to a single menu item, click on the item to select an item to configure.
- To increase a value, rotate the mouse wheel back.
- To decrease a value, rotate the mouse wheel forward.
- To increase a value, move the pointer above the value so that the pointer becomes a , and then click the left mouse button.
- To decrease a value, move the pointer below the value so that the pointer becomes a , and then click the left mouse button.
- To move the decimal place, point to the left or right of the value you want to set so that the pointer becomes a  or a , and then click the left mouse button. The decimal place will move one place to the right or left each time you click the left mouse button.

**Change the value by clicking and using the mouse wheel.**

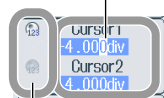

**Click within this area to select the item that you want to set.**

• **Selecting Check Boxes**

To select a check box, click it. To clear a check box, click it again.

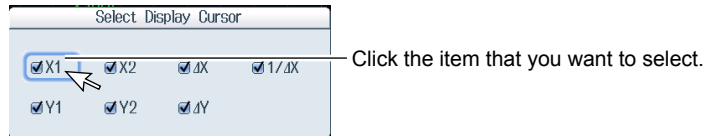

**Note**

To close a dialog box, click outside of it.

• **Selecting a File, Folder, or Media Drive from the File List Window**

Click on a file, folder, or media drive to select it.

Rotate the mouse wheel to scroll through the file list.

To cancel your selection, click outside of the File List window. The File List window will close when you cancel your selection.

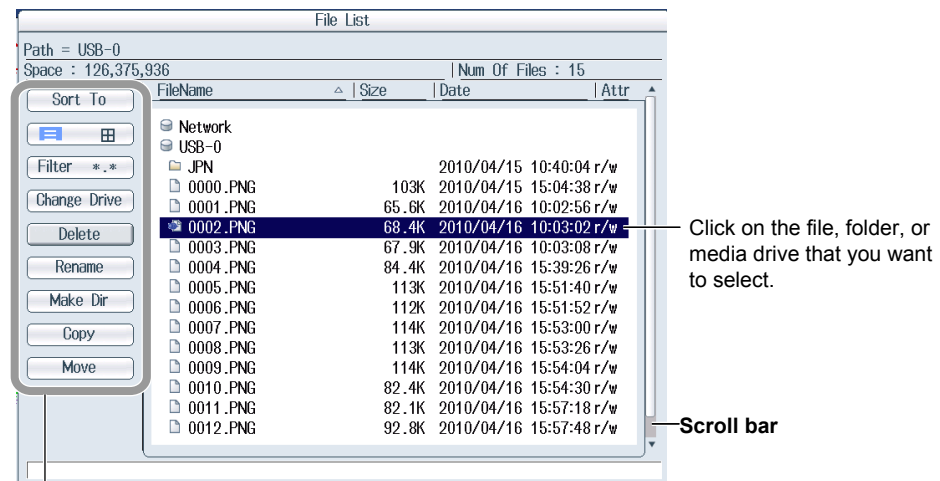

Click on the item that you want to select.

• **Setting V/DIV and TIME/DIV**

**Setting V/DIV**

Move the pointer close to the V/DIV value in the upper left of the display. The pointer becomes a . Rotate the mouse wheel forward to increase the V/DIV value, and rotate it back to decrease the value.

**Setting TIME/DIV**

Move the pointer close to the TIME/DIV value in the upper right of the display. The pointer becomes a . Rotate the mouse wheel forward to increase the TIME/DIV value, and rotate it back to decrease the value.



## 4.4 Synchronizing the Clock

This section explains how to set the DL850/DL850V clock, which is used to generate timestamps for measured data and files. The DL850/DL850V is factory shipped with a set date and time. You must set the clock before you start measurements.

### UTILITY System Config Menu

Press **UTILITY**, the **System Config** soft key, and then the **Date/Time** soft key to display the following screen.

The screenshot shows the 'Date/Time Setup' screen with the following fields and callouts:

- Display:** A toggle switch set to 'ON'. Callout: 'Turns the display of the date and time on and off'.
- Format:** A text field containing '2010/04/20'. Callout: 'Set the display format.'
- Date/Time:** A section with input fields for Year (2010), Month (4), Day (20), Hour (13), Minute (39), and Second (19). A 'Set' button is located below these fields. Callout: 'Set the date and time.'
- Time Diff. GMT:** A section with input fields for Hour (9) and Minute (0). Callout: 'Set the time difference from Greenwich Mean Time.'

### Setting the Display Format (Format)

You can display the date in one of the following formats.

- 2008/09/30 (year/numeric month/day)
- 30/09/2008 (day/numeric month/year)
- 30-Sep-08 (day-English abbreviation of the month-last two digits of the year)
- 30 Sep 2008 (day month (English abbreviation) year)

### Setting the Time Difference from Greenwich Mean Time (Time Diff. GMT)

Set the time difference between the region where you are using the DL850/DL850V and Greenwich Mean Time.

Selectable range: -12 hours 00 minutes to 13 hours 00 minutes

For example, Japan standard time is ahead of GMT by 9 hours. In this case, set Time Hour to 9 and Minute to 00.

#### Checking the Standard Time

Using one of the methods below, check the standard time of the region where you are using the DL850/DL850V.

- Check the Date, Time, Language, Regional Options on your PC.
- Check the standard time at the following URL:<http://www.worldtimeserver.com/>

#### Note

- The DL850/DL850V does not support Daylight Saving Time. To set the time to Daylight Saving Time, reset the time difference from Greenwich Mean Time.
- Date and time settings are backed up using an internal lithium battery. They are retained even if the power is turned off.
- The DL850/DL850V has leap-year information.

## 4.5 Performing Auto Setup

The auto setup feature automatically sets the V/div, Time/div, trigger level, and other settings to the most suitable values for the input signals.

### SETUP Menu

Press **SETUP** to display the following menu.

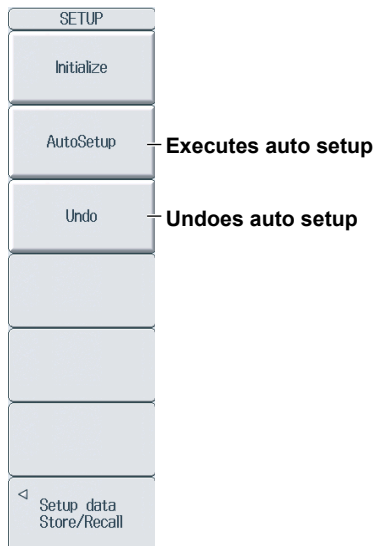

### Center Position after the Execution of Auto Setup

The center position after you execute auto setup will be 0 V.

### Applicable Modules

Auto setup is performed on the following modules.

701250(HS10M12), 701251(HS1M16), 701255(NONISO\_10M12), 701260(HV(with RMS)), 701261(UNIVERSAL), 701262(UNIVERSAL(AAF)), 701275(ACCL/VOLT), 720210(HS100M12), 720220(16CH VOLT)

### Channels That Auto Setup Is Performed On

Auto setup is performed on all channels except logic channels.

Logic waveforms are displayed with the same settings as before you executed auto setup.

### Waveforms Displayed before the Execution of Auto Setup

When you perform auto setup, the data in the acquisition memory is overwritten, and the waveforms that were displayed before you executed auto setup are cleared.

### Undoing Auto Setup

You can press the Undo soft key to revert to the settings that were in effect before you executed auto setup. You cannot undo auto setup if you switch to a different setup menu or clear the SETUP menu using the ESC key.

## Signals That Auto Setup Can Be Applied To

Frequency:	Approx. 50 Hz or higher
Absolute input voltage:	Signals whose maximum value is at least approx. 20 mV (at 1:1 setting)
Type:	Simple, repeating signals

### Note

The auto setup feature may not work properly for signals that include a DC component or high-frequency components.

## Settings after the Execution of Auto Setup

### Waveform Acquisition and Display Settings

START/STOP	START
Acquisition mode	Normal
Acquisition count	Infinite
Record length	10 k
Time base	Int.
Real-time HD recording	Off
Dual capturing	Off
Accumulation	Off

### Vertical axis settings

V/Div	The value that causes the absolute values of the input waveform to be between 1.6 and 4.5 div
Offset voltage	0 V
Coupling	DC
Bandwidth limit	FULL
Display on/off	Channels whose absolute input voltage values reach or exceed 20 mV (1:1) are displayed (except for Scan). The displays of modules that are not affected by auto setup do not change.
DIV/Scale	DIV
Position	0.00 div
V Zoom	×1
T/div	The waveform with the shortest period out of the waveforms affected by auto setup is used to set T/div. T/div is set to the value at which 1.6 to 4 periods of the waveform can be displayed.

### Trigger Settings

Trigger mode	Auto
Trigger type	SIMPLE
Trigger source	The channel with the longest period out of the channels whose amplitude is 1 div or greater
Trigger level/slope	The level between the maximum and minimum values/ rising
Hysteresis	Low
Hold-off	0.0 nsec
Trigger position	50%
Trigger delay	0.0 µsec

### Computation Settings

Math	Off
------	-----

The values of settings not listed here do not change.

## 4.6 Initializing Settings

You can reset the DL850/DL850V settings to their factory default values. This feature is useful when you want to cancel all of the settings that you have entered or when you want to redo measurement from scratch.

### SETUP Menu

Press **SETUP** to display the following menu.



### Settings That Cannot Be Reset to Their Factory Default Values

- Date and time settings
- Communication settings
- Language setting (English or Japanese)

### Undoing the Reset Operation

If you reset the settings by mistake, you can press the Undo soft key to revert to the previous settings. However, you cannot undo the reset operation if you switch to a different setup menu or clear the SETUP menu by pressing the ESC key.

### To Reset All Settings to Their Factory Default Settings

While holding down the RESET key, turn the power switch on. All settings except the date and time settings (display on/off setting will be reset) and the setup data stored in internal memory will be reset to their factory default values.



## 4.7 Calibrating the DL850/DL850V

### CAL Menu

Press **SHIFT+SETUP** (CAL) to display the following menu.

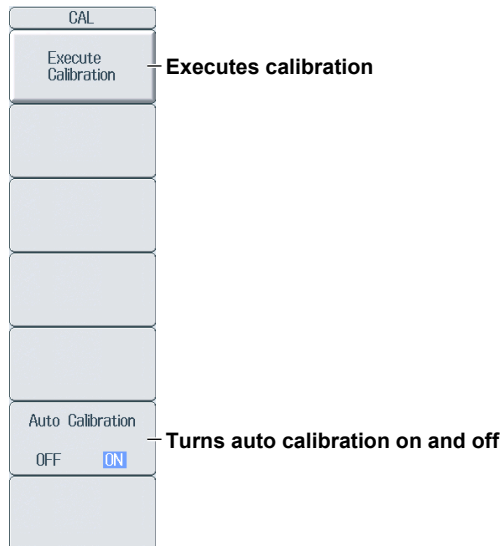

### Calibration

The following items are calibrated. Execute calibration when you want to make accurate measurements.

- Vertical axis ground level and gain
- Trigger threshold level
- Measured time value for repetitive sampling

#### Note

Calibration is performed automatically when the power switch is turned on.

### Notes about Calibration

- Allow the DL850/DL850V to warm up for at least 30 minutes before you execute calibration. If you execute calibration immediately after power-on, the calibrated values may drift due to temperature changes or other environmental changes.
- Execute calibration in an environment with a stable temperature ranging from 5 to 40°C (23 ± 5°C recommended).
- Do not apply signals when calibrating. Calibration may not be executed properly when input signals are being applied to the DL850/DL850V.

### Auto Calibration (Auto Cal)

Auto calibration is executed when you start signal acquisition if you have changed Time/div and any of the time periods listed below has elapsed since the power was turned on.

- 3 minutes
- 10 minutes
- 30 minutes
- One hour and every hour thereafter

If calibration is executed while signals are being applied to the DL850/DL850V, we recommend that you recalibrate the DL850/DL850V without any signals being applied to it.

## 4.8 Starting and Stopping Waveform Acquisition

### Starting and Stopping Waveform Acquisition.

Press **START/STOP** to start or stop waveform acquisition.

The key is illuminated while the DL850/DL850V is acquiring waveforms.

### Waveform Acquisition and Indicators

- When the START/STOP key is illuminated, the DL850/DL850V is acquiring waveforms. “Running” appears in the lower left of the screen.
- When the START/STOP key is not illuminated, waveform acquisition is stopped. “Stopped” appears in the lower left of the screen.

### DL850/DL850V Operation When the Acquisition Mode Is Set to Averaging

- Averaging stops when you stop waveform acquisition.
- If you restart waveform acquisition again, averaging starts from the beginning.

### START and STOP Operations during Accumulation

- Accumulation stops when you stop acquisition.
- If you restart waveform acquisition, past waveforms are cleared, and accumulation starts over.

#### **Note**

You can use the snapshot feature to retain the displayed waveform on the screen. This feature allows you to retain a waveform on the screen while the DL850/DL850V continues signal acquisition.

---

## 4.9 Displaying Help

### Displaying Help

Press the help key () to display help.

The table of contents and index appear in the left frame, and text appears in the right frame.

### Switching between Frames

To switch to the frame that you want to control, use the left and right arrow keys.

### Moving Cursors and Scrolling

To scroll through the screen or to move the cursor in the table of contents or index, turn the jog shuttle.

### Moving to the Link Destination

To move to a description that relates to blue text or to move from the table of contents or index to the corresponding description, move the cursor to the appropriate blue text or item, and press SET.

### Displaying Panel Key Descriptions

With help displayed, press a panel key to display an explanation of it.

### Returning to the Previous Screen

To return to the previous screen, press RESET.

### Hiding Help

Press the help key () to clear help.

# 5.1 External Trigger Input (TRIGGER IN)



## CAUTION

Only apply signals that meet the following specifications. Signals that do not meet the specifications may damage the DL850/DL850V, because of factors such as excessive voltage.

### External Trigger Input Terminal



This terminal is used when an external signal is used as the trigger source.

Item	Specifications
Connector type	BNC
Input level	TTL (0 to 5 V)
Minimum pulse width	100 ns
Logic	Rising and falling edges
Trigger delay time	Within 100 ns + 1 sample period
Externally synchronized operation	Possible (through the connection of the TRIG IN and TRIG OUT terminals of two DL850/DL850Vs)

### Circuit Diagram and Timing Chart for External Trigger Input

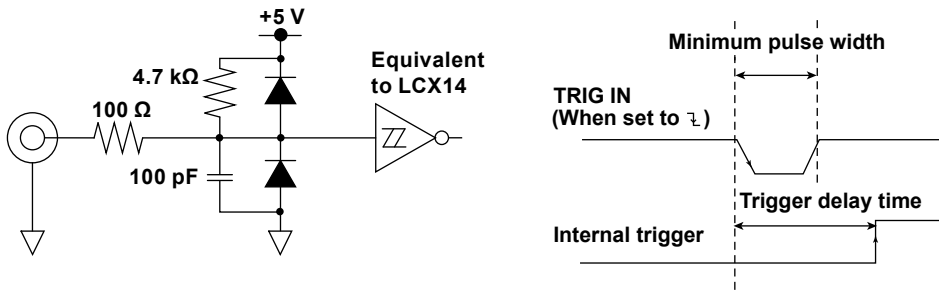

#### Note

You can synchronize the operation of two DL850/DL850Vs by using the trigger output function.

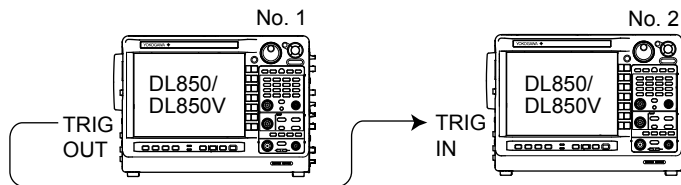

## 5.2 Trigger Output (TRIGGER OUT)



### CAUTION

Do not short the TRIG OUT terminal or apply external voltage to it. Doing so may damage the instrument.

### External Trigger Output Terminal

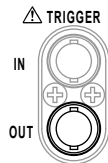

When a trigger occurs, the DL850/DL850V produces a CMOS level signal. You can set the output mode to normal or pulse. The signal level is normally high. It becomes low when a trigger occurs.

Item	Specifications				
Connector type	BNC				
Output level	CMOS level (0 to 5 V)				
Output formats	Normal mode and pulse mode				
Logic	<table border="0"> <tr> <td>Normal mode</td> <td>Low when a trigger occurs and high after acquisition is completed</td> </tr> <tr> <td>Pulse mode</td> <td>Low when a trigger occurs and high after a specified period of time has passed.</td> </tr> </table>	Normal mode	Low when a trigger occurs and high after acquisition is completed	Pulse mode	Low when a trigger occurs and high after a specified period of time has passed.
Normal mode	Low when a trigger occurs and high after acquisition is completed				
Pulse mode	Low when a trigger occurs and high after a specified period of time has passed.				
Output delay	<table border="0"> <tr> <td>Normal mode</td> <td>Within 100 ns + 1 sample period</td> </tr> <tr> <td>Pulse mode</td> <td>Within 100 ns + 1 sample period</td> </tr> </table>	Normal mode	Within 100 ns + 1 sample period	Pulse mode	Within 100 ns + 1 sample period
Normal mode	Within 100 ns + 1 sample period				
Pulse mode	Within 100 ns + 1 sample period				
Output hold time	<table border="0"> <tr> <td>Normal mode</td> <td>100 ns or more</td> </tr> <tr> <td>Pulse mode</td> <td>1 ms, 50 ms, 100 ms, or 500 ms</td> </tr> </table>	Normal mode	100 ns or more	Pulse mode	1 ms, 50 ms, 100 ms, or 500 ms
Normal mode	100 ns or more				
Pulse mode	1 ms, 50 ms, 100 ms, or 500 ms				

### Circuit Diagram and Timing Chart for Trigger Output

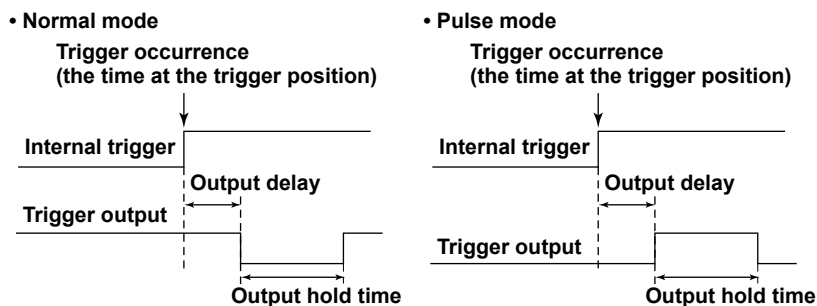
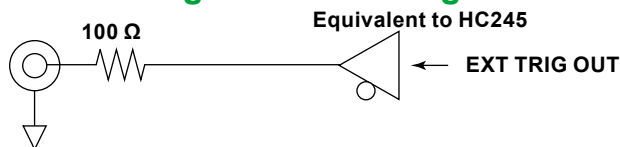

### Low Level and High Level Hold Times (In normal mode)

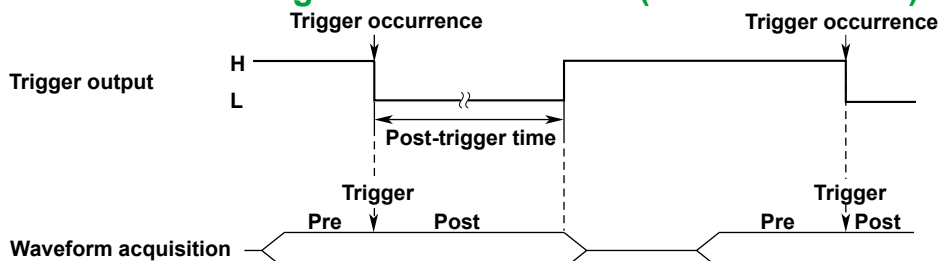

## 5.3 External Clock Input (EXT CLK IN)



### CAUTION

Only apply signals that meet the following specifications. Signals that do not meet the specifications may damage the DL850/DL850V, because of factors such as excessive voltage.

### External-clock input terminal



Use this terminal to operate the DL850/DL850V using an external clock signal.

Item	Specifications
Connector type	BNC
Input level	TTL (0 to 5 V)
Detected edge	Rising
Minimum pulse width	50 ns or more for both high and low
External clock frequency range	Up to 9.5 MHz

### Circuit Diagram for External Clock Input

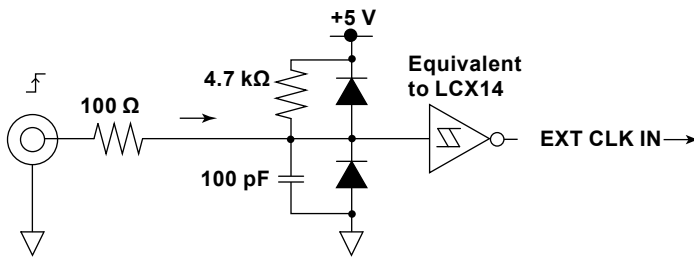

## 5.4 Video Signal Output (VIDEO OUT (XGA))



### CAUTION

- Only connect the DL850/DL850V to a monitor after turning both the DL850/DL850V and the monitor off.
- Do not short the VIDEO OUT terminal or apply external voltage to it. Doing so may damage the DL850/DL850V.

### Video Signal Output Terminal

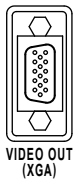

You can use video signal output to display the DL850/DL850V screen on a monitor. Any multisync monitor that supports XGA can be connected.

Item	Specifications
Connector type	D-sub 15-pin
Output format	Analog RGB output
Output resolution	XGA output, 1024 × 768 dots, approx. 60 Hz Vsync

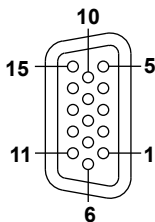

D-Sub 15-pin receptacle

Pin No.	Signal	Specifications
1	Red	0.7 V <sub>P-P</sub>
2	Green	0.7 V <sub>P-P</sub>
3	Blue	0.7 V <sub>P-P</sub>
4	—	
5	—	
6	GND	
7	GND	
8	GND	
9	—	
10	GND	
11	—	
12	—	
13	Horizontal sync signal	Approx. 36.4 kHz, TTL positive logic
14	Vertical sync signal	Approx. 60 Hz, TTL positive logic
15	—	

### Connecting to a Monitor

1. Turn off the DL850/DL850V and the monitor.
2. Connect the DL850/DL850V and the monitor using an RGB cable.
3. Turn on the DL850/DL850V and the monitor.

## 5.5 GO/NO-GO Determination I/O and External Start/Stop Input (EXT I/O)

### Connecting to Other Instruments



#### CAUTION

- Do not apply external voltage to the NO-GO OUT and GO OUT output pins. Doing so may damage the instrument.
- When connecting the GO/NO-GO determination signal output to another device, do not connect the wrong signal pin. Doing so may damage the DL850/DL850V or the connected instrument.
- Do not connect a USB cable to the GO/NO-GO output terminal. Doing so may damage the instrument.

### About the External I/O Cable (720911; sold separately)

- Do not use the cable for anything other than the DL850/DL850V external I/O.
- Refer to the following figure to connect the cable to an external device.

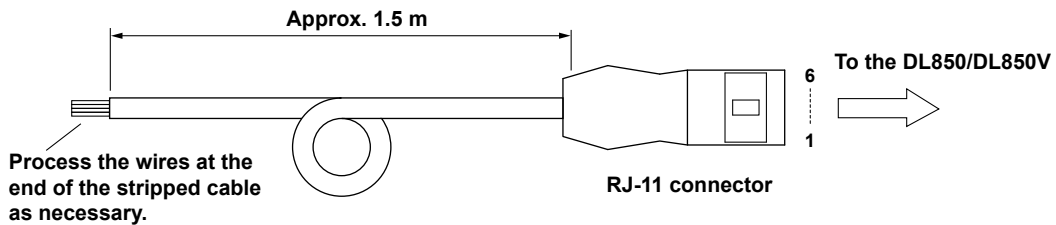

Wire color	Pin no.	Signal	Logic
Red	1	EXT EVENT IN	Negative logic
Yellow	2	START IN	Negative logic
White	3	GO OUT	Negative logic
Green	4	NOGO OUT	Negative logic
Blue	5	GND	

### GO/NO-GO Determination I/O

You can apply an external signal to the DL850/DL850V's GO/NO-GO I/O terminal and perform GO/NO-GO determination, and you can output the results of GO/NO-GO determination from the GO/NO-GO I/O terminal.

### GO/NO-GO I/O Connector

#### Type

The connector uses an RJ-11 modular jack. Use the external I/O cable accessory (720911; sold separately). If you are using a commercially sold cable (four-conductor modular telephone cable), wire the pins according to the above figure.

#### I/O Level

Within 0 to 5 V, threshold level: TTL

#### Pinout

EXT I/O

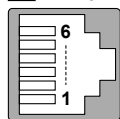

Connector on the DL850

Pin no.	Signal		
1	EXT EVENT IN	IN	Manual event. Event input occurs on low edge.
2	START IN	IN	Starts on low edge
3	GO OUT	OUT	Active low (GO)
4	NOGO OUT	OUT	Active low (NO-GO)
5	GND		
6	NC (no connection)		



### Input Signal

#### START IN (Negative logic)

Use this signal to perform GO/NO-GO determination by synchronizing to an external input signal. The signal is only valid when on the GO/NO-GO menu, Remote is set to ON. If Remote is set to OFF, GO/NO-GO determination is performed regardless of the external signal input (the GO/ NO-GO determination result is output).

See the next page for the timing chart.

#### Signal Input Circuit

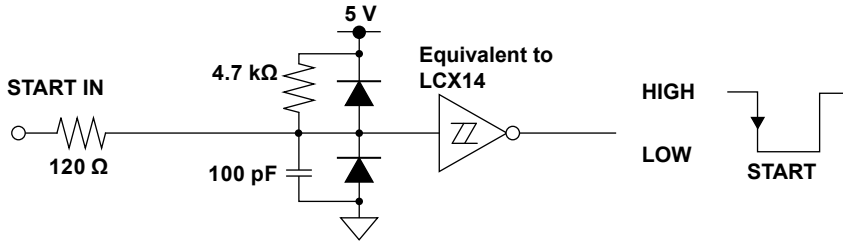

### Output Signal

#### NOGO OUT (Negative logic)

When the determination result is NO-GO (fail), the output signal level temporarily changes from high (H) to low (L).

#### GO OUT (Negative logic)

When the determination result is GO, the output signal level temporarily changes from high (H) to low (L).

#### Signal Output Circuit

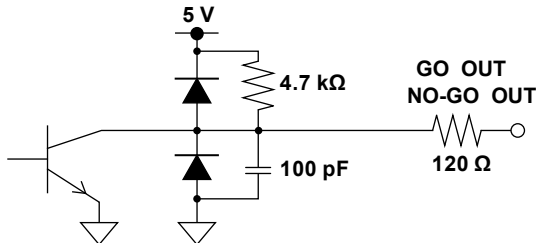

### GO/NO-GO I/O Timing

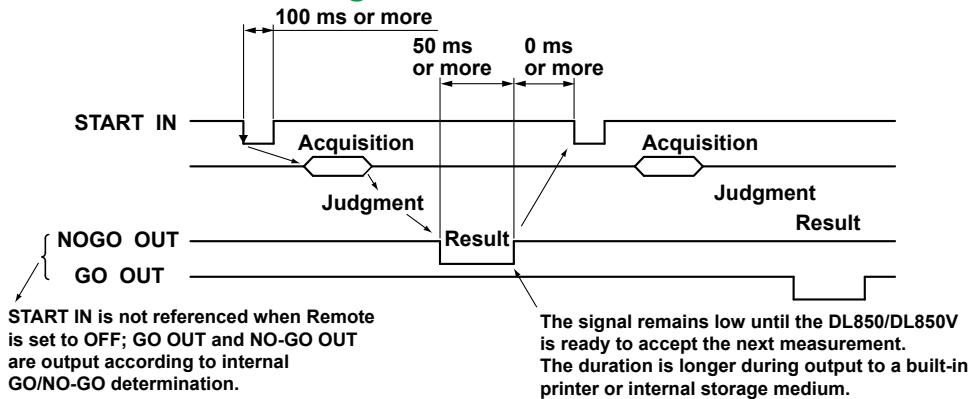

## External Start/Stop Input (EXT I/O)

You can use an external signal to start and stop the DL850/DL850V.

### External Start/Stop Input Terminal

The External Start/Stop Input terminal and the GO/NO-GO I/O terminal are the same terminal. This terminal is used as an external start/stop input when the GO/NO-GO determination I/O function is not used (when on the GO/NO-GO menu, Mode is set to OFF).

#### Specifications

The connector uses an RJ-11 modular jack. Connect the separately sold 720911 cable to the connector.

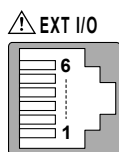

Connector on the DL850/DL850V

Input level: TTL (0 to 5 V)

Pin no.	Signal
1	EXT EVENT IN— Manual event. Event input occurs on low edge.
2	START IN — Starts on low edge, stops on high
3	NC (no connection)
4	NC (no connection)
5	GND
6	NC (no connection)

### Circuit Diagram for External Start/Stop Input

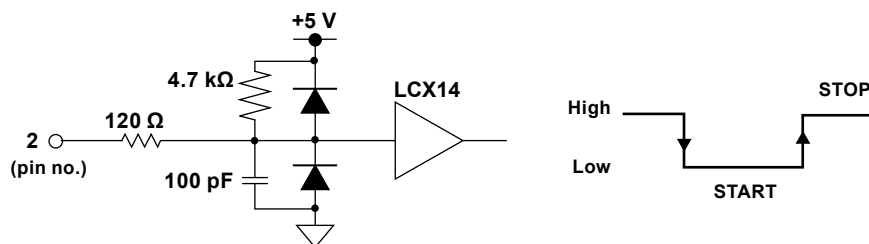

• Contact input is possible

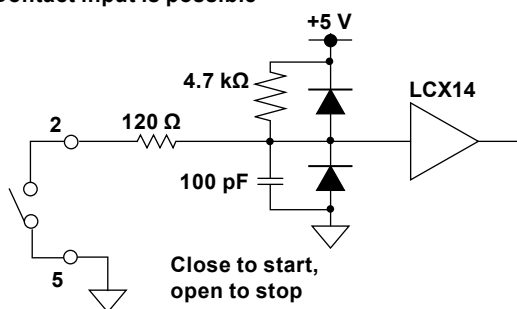

#### Note

- Low and high edges are used to detect starts and stops.
- You can select whether to ignore high edges (stops) in the external start/stop signal. For information about how to do so, see section 18.8, “Configuring the Environment Settings,” in the user’s manual.

## 5.6 IRIG Signal Input (IRIG option)



### CAUTION

Only apply signals that meet the following specifications. Signals that do not meet the specifications may damage the DL850/DL850V, because of factors such as excessive voltage.

### IRIG Signal Input Terminal



You can use an IRIG (Inter Range Instrumentation Group) signal to set the time on the DL850/DL850V.

Item	Specifications
Input connector	BNC
Number of input connectors	1
Supported IRIG signals	A002, B002, A132, and B122
Input impedance	You can switch between 50 $\Omega$ and 5 k $\Omega$ .
Maximum input voltage	$\pm 8$ V
Used for	Synchronizing the DL850/DL850V time Synchronizing the sample clock
Clock sync range	$\pm 80$ ppm
Post-sync accuracy	No drift from the input signal

## 6.1 Signal Input Section

Item	Specifications
Type	Plug-in input unit
Number of slots	8
Maximum number of input channels	16 channels per slot, 128 channels per unit (when a 16-CH Voltage Input Module is installed in each slot)
Maximum record length	The maximum length when all channels are being used depends on the number of channels in each module. The maximum values when the entire memory is used are listed below. Standard 250 Mpoint when 1 channel is being used. 10 Mpoint per channel when 16 channels are being used. /M1 option 1 Gpoint when 1 channel is being used. 50 Mpoint per channel when 16 channels are being used. /M2 option 2 Gpoint when 1 channel is being used. 100 Mpoint per channel when 16 channels are being used.

## 6.2 Triggering Section

Item	Specifications
Trigger mode	Auto, Auto Level, Normal, Single, N Single, or On Start
Selectable trigger level range	0 ± 10 div
Trigger hysteresis	When measuring voltage: Select from ±0.1 div, ±0.5 div, and ±1 div. When measuring temperature: Select from ±0.5°C, ±1.0°C, and ±2.0°C. When measuring strain: Select from ±2.5%, ±12.5%, and ±25%. When measuring acceleration: Select from ±0.1 div, ±0.5 div, and ±1 div. When measuring frequency: Select from ±0.01 div, ±0.5 div, and ±1 div.
Selectable trigger position range	0 to 100% (of the display record length; resolution: 0.1%)
Selectable trigger delay range	0 to 10 s (resolution: 10 ns)
Selectable hold-off time range	0 to 10 s (resolution: 10 ns)
Manual trigger key	A dedicated manual trigger key can be used.
Simple trigger	
Trigger source	CHn (select an input channel), EXT, LINE, or Time
Trigger slope	Rising, falling, or rising or falling
Time trigger	Date (year, month, and day), time (hour and minute), and time interval (10 seconds to 24 hours)
Enhanced trigger	
Trigger source	CHn (select an input channel)
Trigger type	A → B(N): After the trigger A conditions are met, the DL850/DL850V triggers when the trigger B conditions are met N times. Count: 1 to 10000 Condition A: Enter/Exit Condition B: Enter/Exit A Delay B: After the specified amount of time elapses after the trigger A conditions are met, the DL850/DL850V triggers when the trigger B conditions are first met. Time: 0 to 10 s (resolution: 10 ns) Condition A: Enter/Exit Condition B: Enter/Exit Edge on A: While the trigger A conditions are met, the DL850/DL850V triggers on the OR of multiple trigger source edges. Condition A: True/False AND: The DL850/DL850V triggers on the AND of multiple state conditions. OR: The DL850/DL850V triggers on the OR of multiple trigger source edges or states (or Window triggers) Pulse Width B>Time: The DL850/DL850V triggers when the time from when the trigger B conditions are met to when they change from being met to not being met is greater than the specified time. Time: 20 ns to 10 s (resolution: 10 ns)

## 6.2 Triggering Section

Item	Specifications
B<Time:	The DL850/DL850V triggers when the time from when the trigger B conditions are met to when they change from being met to not being met is less than the specified time. Time: 20 ns to 10 s (resolution: 10 ns)
B Time Out:	The DL850/DL850V triggers when the trigger B conditions continue to be met for the specified period of time. Time: 20 ns to 10 s (resolution: 10 ns)
B Between	The DL850/DL850V triggers when the period during which the trigger B conditions continue to be met is within the specified time range. Time T1: 10 ns to 9.99999999 s T2: 20 ns to 10 s (resolution: 10 ns)
Period:	The DL850/DL850V triggers when the period meets one of the following conditions.
T>Time:	The DL850/DL850V triggers when the period of the trigger T conditions is longer than the specified time. Time: 20 ns to 10 s (resolution: 10 ns)
T<Time:	The DL850/DL850V triggers when the period of the trigger T conditions is less than the specified time. Time: 20 ns to 10 s (resolution: 10 ns)
T1<T<T2:	The DL850/DL850V triggers when the period of the trigger T conditions is within the specified time range. Time: T1: 20 ns to 10 s (resolution: 10 ns) T2: 30 ns to 10 s (resolution: 10 ns)
T<T1, T2<T:	The DL850/DL850V triggers when the period of the trigger T conditions is outside of the specified time range. Time: T1: 20 ns to 10 s (resolution: 10 ns) T2: 30 ns to 10 s (resolution: 10 ns)
Window:	The DL850/DL850V triggers when the trigger source enters or exits the range of two specified levels. The DL850/DL850V can trigger on the OR of the window triggers of multiple channels.
Wave Window:	This trigger is for monitoring power supplies. The DL850/DL850V creates templates in real time by comparing 1, 2, or 4 cycles directly preceding the current waveforms using a tolerance value, compares the current waveforms to the real-time templates, and triggers if one of the current waveforms falls outside of its real-time template.
	<ul style="list-style-type: none"> <li>•The trigger A and B conditions can be set to High, Low, or Don't Care for each channel. The AND of the conditions (the parallel pattern) is used to determine the result.</li> <li>• For OR and AND, the condition can be set to High, Low, IN, OUT, or Don't Care for each channel.</li> </ul>

## 6.3 Time Axis

Item	Specifications
Selectable time scale range	The display of minutes per div, hours per div, and days per div is also possible. 100 ns/div <sup>1</sup> to 1 s/div (in 1-2-5 steps), 2 s/div, 3 s/div, 4 s/div, 5 s/div, 6 s/div, 8 s/div, 10 s/div, 20 s/div, 30 s/div, 1 min/div to 10 min/div (in 1 min steps), 12 min/div, 15 min/div, 30 min/div, 1 h/div to 10 h/div (in 1 h steps), 12 h/div, 1 day/div, 2 days/div, 3 days/div
Time accuracy <sup>2</sup>	±0.005%
External clock input	Connector type: BNC Input level: TTL level Detected edge: Rising Frequency range: Up to 9.5 MHz Minimum pulse width: 50 ns or more for both High and Low

- 1 1 µs/div when the High-Speed 100 MS/s, 12-Bit Isolation Module (720210) is not installed
- 2 Under standard operating conditions after the warm-up time has passed

## 6.4 Display

Item	Specifications
Display	10.4-inch TFT LCD
Display screen size	210.4 mm × 157.8 mm
Display resolution*	1024 × 768 (XGA)
Resolution of the waveform display	801 × 656 (normal) or 1001 × 656 (wide)
Display format	Divisions: Up to three screen divisions can be displayed at the same time. Each division can contain one of the following windows: TY, ZOOM1, ZOOM2, XY1, XY2, FFT1, or FFT2.

\* The LCD may include a few defective pixels (within 5 ppm over the total number of pixels including RGB). The LCD may contain some pixels that are always illuminated or that never light. Please be aware that these are not defects.

## 6.5 Features

### Waveform Acquisition and Display

Item	Specifications
Acquisition mode	Normal: Normal waveform acquisition
	Envelope: The peak values are held at the maximum sample rate regardless of the Time/div setting.
	Averaging: The number of times to average can be set to 2 to 65536 in 2 <sup>n</sup> steps.
	Box average: Increases the A/D resolution by up to 4 bits (16 bits max.).
Record length	1 kpoint, 2.5 kpoint, 5 kpoint, 10 kpoint, 25 kpoint, 50 kpoint, 100 kpoint, 250 kpoint, 500 kpoint, 1 Mpoint, 2.5 Mpoint, 5 Mpoint, 10 Mpoint, 25 Mpoint, 50 Mpoint, 100 Mpoint, 250 Mpoint, 500 Mpoint(on models with the /M1 or /M2 option), 1000 Mpoint(on models with the /M1 or /M2 option), 2000 Mpoint(on models with the /M2 option)
Zoom	The displayed waveform is expanded along the time axis (up to two locations can be zoomed at separate zoom factors).
	Auto scrolling: The DL850/DL850V automatically scrolls to the zoom position.
Display format	1, 2, 3, 4, 6, 8, 12, 16 analog waveform windows
Maximum number of displayed traces	64 traces per display group. You can switch between four display groups.
Display interpolation	Sampled points can be displayed through the use of dots (OFF), sine interpolation, linear interpolation, or pulse interpolation.
Graticule	Three graticule types to choose from
Auxiliary display on/off	Scale values, waveform labels, the extra window, the level indicator, and the numeric display can be turned on and off.
X-Y display	The X and Y axes can be selected from CHn and MATHn (Max. four traces × two windows).
Accumulation	Persistence mode
Snapshot	The currently displayed waveforms can be retained on the screen. Snapshot waveforms can be saved and loaded.
Clear trace	The displayed waveform is cleared.
Dual capturing	The data of a single waveform can be acquired at two different sample rates.
	Main waveform Maximum sample rate: 100 kS/s (roll mode area)
	Captured waveform Maximum sample rate: 100 MS/s*
Hard disk recording (when the /HD0 or /HD1 option is installed)	Record length: 5 kpoint, 10 kpoint, 25 kpoint, 50 kpoint, 100 kpoint, 250 kpoint, 500 kpoint
	Maximum sample rate: Depends on the number of channels being used. 1 MS/s when 1 channel is being used. 100 kS/s when 16 channels are being used.
	Capacity: Depends on the amount of free space on the HDD
	Operation overview: When waveform acquisition occurs according to the specified trigger mode, the DL850/DL850V stores the data to an internal hard disk or an external hard disk that supports eSATA.

\* 10 MS/s when the High-Speed 100 MS/s, 12-Bit Isolation Module (720210) is not installed

## Vertical and Horizontal Control

Item	Specifications
Channel on/off	CHn and MATHn can be turned on and off separately.
ALL CH menu	You configure the settings of all channels while displaying waveforms. You can use a USB keyboard or mouse.
Vertical axis zooming	×0.1 to ×100 (varies depending on the module) You set the scale using upper and lower limits or switch between different scales.
Vertical position setting	Waveforms can be moved in the range of ±5 div from the center of the waveform display frame.
Linear scaling	The linear scaling mode can be set separately for each channel (only for voltage, stress, and frequency). It can be set to AX+B or P1-P2.
Roll mode	Roll mode is enabled automatically when the trigger mode is set to Auto, Auto Level, Single, or On Start, and the time axis setting is greater than or equal to 100 ms/div.

## Analysis

Item	Specifications
Zooming and searching	You can search for and then expand and display a portion of the displayed waveform. You can choose from the following search methods. Edge: The DL850/DL850V counts the number of rising or falling edges Logic pattern: The DL850/DL850V counts the number of times a logic pattern is detected. Event: The DL850/DL850V searches for an event number. Time: The DL850/DL850V searches for a date and time.
History search feature	You can search through history waveforms for specified conditions. Zone search: The DL850/DL850V displays waveforms that pass through or do not pass through a specified area on the screen. Parameter search: The DL850/DL850V displays a waveform when the results of the automated measurement of its parameters meet the specified conditions.
Cursor measurement	Horizontal, Vertical, H&V, Degree (only during T-Y waveform display) and Marker
Automated measurement of waveform parameters	Automated measurement of waveform parameters Up to 24 items can be displayed. P-P, Amp, Max, Min, High, Low, Avg, Mid, Rms, Sdev, +OvrShoot, -OvrShoot, Rise, Fall, Freq, Period, +Width, -Width, Duty, Pulse, Burst1, Burst2, AvgFreq, AvgPeriod, Int1TY, Int2TY, Int1XY, Int2XY, Delay(between channels)
Statistical processing	Applicable items: Automated measurement values of waveform parameters Statistical items: Max, Min, Avg, Sdv, and Cnt Maximum number of cycles: 64000 cycles (when the number of parameters is 1) Maximum total number of parameters: 64000 Maximum measurement range: 100 Mpoint
Normal statistical processing	Statistical processing is performed while waveforms are acquired.
Cyclic statistical processing	The DL850/DL850V automatically measures the waveform parameters of the data in the acquisition memory and performs statistical processing on the parameters once per period.
Statistical processing of the history data	The DL850/DL850V automatically measures the waveform parameters of each history waveform and performs statistical processing on the parameters.
Computation	Operators: +, -, ×, ÷, binary computation, phase shift, and power spectrum
User-defined computation (/ G2 option)	Expressions can be created through the combination of the following operators and constants. ABS, SQRT, LOG, EXP, NEG, SIN, COS, TAN, ATAN, PH, DIF, DDIF, INTG, IINTG, BIN, P2, P3, F1, F2, FV, PWHH, PWHL, PWLH, PWLL, PWXX, DUTYH, DUTYL, FILT1, FILT2, HLBT, MEAN, LS-, PS-, PSD-, CS-, TF-, CH-, MAG, LOGMAG, PHASE, REAL, IMAG
Phase shifting	You can monitor the waveform of a specified channel with its phase shifted
GO/NO-GO determination	The following two types of GO/NO-GO determination are available: • Determination using zones on the screen • Determination using the automated measurement values of waveform parameters. The following operations can be performed at the time of determination: Output of screen capture data, saving of waveform data (to binary, ASCII, or floating-point), sounding of a notification buzzer, transfer of e-mail

## Screen Capture Data Output

Item	Specifications
Built-in printer (/B5 option)	A hard copy of the screen can be output.
External printer	Prints screen captures on an external printer connected over an Ethernet.
File format	PNG, JPEG, or BMP

## Data Storage

Item	Specifications
History memory	Automatically holds up to 5000 pages of waveforms (depending on the record length)
Internal HDD and external storage media	Waveform data, setup data, automated measurement values, and the results of statistical processing can be saved.

## Other Features

Item	Specifications
Initialization	Resets settings to the factory default (excluding the date and time setting, communication interface settings, language setting, and time difference from GMT setting). The reset can be undone.
Auto setup	Automatically sets the voltage axis, time axis, trigger, etc. The automatic settings can be undone.
Action-on-trigger	Outputs screen capture data, saves waveform data (to binary, ASCII, or floating-point), sounds a notification buzzer, transfers an e-mail, or performs some combination of the previous actions whenever a trigger occurs
E-mail transmission	Sends e-mail using SMTP
Calibration	Auto or manual
System settings	Screen color, date and time, message language, menu language, click sound on/off, and grid thickness
Overview	The system specifications can be displayed.
Self tests	Memory test, key test, printer test, and storage test
Help feature	Displays a description of the settings
PROTECT key	You can lock the keys to prevent unintentional operations.
NUM key	You can enter numbers directly.
Japanese string input	Compact-VJE Ver.3.0



## 6.6 FFT

Item	Specifications
Waveform to be computed	CHn or MATHn
Number of channels	1 (on models without the /G2 option), 2(on models with the /G2 option)
Computation range	From the specified computation start point until the specified number of points have been computed
Computed points	1 k, 2 k, 5 k, 10 k, 20 k, 50 k, or 100 k
Time windows	<p>Rect, Hanning, Hamming, FlatTop, and Exponential (on models with the /G2 option)</p> <p>When the Exponential time window is selected, the following settings must be configured.</p> <p>Damping rate: The weight of the last data point, with the weight of the first data point in the specified number of FFT points taken to be 100% (= 1).</p> <p>Selectable range: 1 to 100%</p> <p>Resolution: 1%</p> <p>Force1: Set the area over which computation is performed in terms of a percentage from the first FFT point, taking the number of FFT points to be 100%.</p> <p>Selectable range: 1 to 100%</p> <p>Resolution: 1%</p> <p>Force2: This setting applies to the output (response) signal (second parameter) of a two-waveform FFT.</p> <p>Selectable range: 1 to 100%</p> <p>Resolution: 1%</p>
Display window	<p>The FFT computation results are displayed in a separate window independent from the normal waveform display.</p> <p>Display range: Set the display range by setting Center and Sensitivity.</p>

## 6.7 Built-in Printer

Item	Specifications
Print system	Thermal line dot system
Sheet width	112 mm
Effective print width	104 mm (832 dots)
Dot density	8 dot/mm
Feeding direction resolution	8 dot/mm
Used for	Producing a hard copy of the screen

## 6.8 Storage

### SD Memory Card

Item	Specifications
Number of slots	1
Maximum capacity	16 GB
Supported cards	SD and SDHC compliant memory cards

### Internal HDD (/HD1 option)

Item	Specifications
Number of drives	1
Size	2.5 in.
HDD capacity used	160 GB, FAT32

### USB Ports for Peripherals

Item	Specifications
Compatible USB storage devices	Mass storage devices that are compliant with USB Mass Storage Class Ver. 1.1

### External HDD Interface (/HD0 option)

Item	Specifications
Connection interface	eSATA
Number of drives	1
Usable HDD capacity	1.5 TB, FAT32

## 6.9 USB for Peripherals

Item	Specifications
Connector type	USB type A (receptacle)
Electrical and mechanical specifications	USB Rev. 2.0 compliant
Supported transfer mode	HS (High Speed; 480 Mbps), FS (Full Speed; 12 Mbps), LS (Low Speed; 1.5 Mbps)
Compatible devices	Mass storage devices that are compliant with USB Mass Storage Class Ver. 1.1 104 or 109 keyboards that are compliant with USB HID Class Version 1.1 Mouse devices that are compliant with USB HID Class Version 1.1
Number of ports	2
Power supply	5 V, 500 mA (for each port)

## 6.10 Auxiliary I/O Section

### External Trigger Input (TRIGGER IN)

Item	Specifications
Connector type	BNC
Input level	TTL
Minimum pulse width	100 ns
Detected edge	Rising or falling
Trigger delay time	Within 100 ns + 1 sample

### Trigger Output (TRIGGER OUT)

Item	Specifications
Connector type	BNC
Output level	5 V CMOS
Logic	Low when a trigger occurs and high after acquisition is completed
Output delay	Within 100 ns + 1 sample
Output hold time	100 ns or more

### External Clock Input (EXT CLK IN)

Item	Specifications
Connector type	BNC
Input level	TTL
Minimum pulse width	50 ns
Detected edge	Rising
Sampling jitter	Within 100 ns + 1 sample

### Video Signal Output (VIDEO OUT)

Item	Specifications
Connector type	D-sub 15 pin receptacle
Output format	Analog RGB
Output resolution	XGA-compliant output, 1024 × 768 dots Approx. 60 Hz Vsync (dot clock frequency: 66 MHz)

### GO/NO-GO Determination I/O

Item	Specifications
Connector type	RJ-11 modular jack
Input level	TTL or contact
Output level	5 V CMOS

### External Start/Stop Input

Item	Specifications
Connector type	RJ-11 modular jack
Input level	TTL or contact

## COMP Output (Probe-compensation-signal output terminal)

Item	Specifications
Output signal frequency	1 kHz $\pm$ 1%
Output amplitude	1 V <sub>p-p</sub> $\pm$ 10%

## Probe Power Output (/P4 Option)

Item	Specifications
Number of output terminals	4
Output voltage	$\pm$ 12 V
Output current	Up to 1 A

## Time Sync Signal Input (IRIG; /C20 option)

Item	Specifications
Input connector	BNC
Number of input connectors	1
Supported IRIG signals	A002, B002, A132, and B122
Input impedance	You can switch between 50 $\Omega$ and 5 k $\Omega$ .
Maximum input voltage	$\pm$ 8 V
Used for	Synchronizing the DL850/DL850V time Synchronizing the sample clock
Clock sync range	$\pm$ 80 ppm
Post-sync accuracy	No drift from the input signal

## 6.11 Computer Interface

### USB-PC Connection

Item	Specifications
Connector type	USB type B receptacle
Electrical and mechanical specifications	USB Rev. 2.0 compliant
Supported transfer mode	HS (High Speed; 480 Mbps) and FS (Full Speed; 12 Mbps)
Number of ports	1
Supported protocols	USBTMC-USB488 (USB Test and Measurement Class Ver. 1.0)
PC system requirements	A PC with a USB port, running the English or Japanese version of Windows 7 (32 bit), Windows Vista (32 bit), or Windows XP (32 bit, SP2 or later)

### Ethernet

Item	Specifications
Connector type	RJ-45 modular jack
Ports	1
Electrical and mechanical specifications	IEEE802.3
Transmission system	Ethernet (1000BASE-T, 100BASE-TX, 10BASE-T)
Communication protocol	TCP/IP
Supported services	DHCP, DNS, SNTP client, SMTP client, FTP server and client, LPR, Web server, and VXI11

## 6.11 Computer Interface

---

### GP-IB (/C1 or /C20 option)

Item	Specifications
Connector type	24-pin connector
Electrical specifications	Complies with IEEE St'd 488-1978 (JIS C 1901-1987)
Functional specifications	SH1, AH1, T6, L4, SR1, RL1, PP0, DC1, DT0, and C0
Protocol	IEEE St'd 488.2-1992
Code	ISO (ASCII)
Mode	Addressable mode
Address	Talker and listener addresses can be specified from 0 to 30.
Remote mode release	Remote mode can be cleared with the SHIFT+CLEAR TRACE key (except during Local Lockout).

## 6.12 General Specifications

Item	Specifications
Standard operating conditions	Ambient Temperature: 23 ± 5°C Ambient humidity: 20 to 80% RH Supply voltage and frequency errors: Within ±1% of rating After the DL850/DL850V has been warmed up for 30 minutes and then calibration has been performed
Recommended calibration period	1 year
Warm-up time	At least 30 minutes
Storage environment	Temperature: -20 to 60°C Humidity: 20 to 85% RH (no condensation) Altitude: 3000 m or less
Operating environment	Temperature: 5 to 40°C Humidity: 20 to 85% RH (when the printer is not being used) 35 to 85% RH (when the printer is used) In both cases, no condensation Altitude: 2000 m or less
Rated supply voltage	100 to 120 VAC, 220 to 240 VAC (auto switching)
Permitted supply voltage range	90 to 132 VAC, 198 to 264 VAC
Rated supply frequency	50/60 Hz
Permitted supply voltage frequency range	48 to 63 Hz
Power fuse	Built in (not replaceable)
Maximum power consumption	200 VA
Withstand voltage	1500 VAC for one minute between the power supply and case
Insulation resistance	10 MΩ or more for 500 VDC between the power supply and case
External dimensions	Approx. 355 mm (W) × 259 mm (H) × 180 mm (D), not including the handle and protrusions
Weight	Approx. 6.5 kg (weight of the DL850/DL850V only without paper and with the /M2, /HD1, /C1, and /P4 options installed)
Instrument cooling method	Forced air cooling. Exhaust on the left side and top panel.
Battery backup	The settings and clock are backed up with an internal lithium battery.
Backup battery life	Approx. five years (at an ambient temperature of 25°C)
Safety standard	Compliant standards EN61010-1, EN61010-031, EN 60825-1 • Overvoltage category (installation category) II <sup>1</sup> • Measurement Category II <sup>2</sup> • Pollution degree 2 <sup>3</sup> Approved (DL850/DL850V, 701250, 701251, 701255, 701260, 701261, 701262, 701265, 701270, 701271, 701275, 701280, 720210, 720220, 720230, 720240, 700986, 700987, 701955, 701956, 701957, 701958, 702911, 702912) • Bridgehead for the strain module Use the 701955 or 701956 with the 701270, and use the 701957 or 701958 with the 701271.

## 6.12 General Specifications

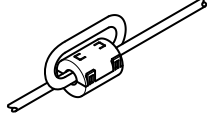
Item	Specifications
Emissions	<p>Compliant standards</p> <p>EN61326-1 ClassA, EN61326-2-1, C-Tick EN55011 ClassA, Group1</p> <p>Approved (DL850/DL850V, 701250, 701251, 701255, 701260, 701261, 701262, 701265, 701270, 701271, 701275, 701280, 720210, 720220, 720230, 720240, 700986, 700987, 701955, 701956, 701957, 701958, 702911, 702912)</p> <p>This product is a Class A (for industrial environments) product. Operation of this product in a residential area may cause radio interference in which case the user is required to correct the interference.</p> <p>Test items</p> <ol style="list-style-type: none"> <li>1. Power supply terminal noise</li> <li>2. Radiation emission</li> <li>3. Power supply harmonic regulation</li> <li>4. Power supply voltage fluctuation and flicker</li> </ol> <p>Cable conditions (DL850/DL850V)</p> <p>Current probe</p> <p>When connecting a current probe to the input terminal and probe power terminal of a module, attach a single ferrite core<sup>4</sup> to both cables on the side of the cables closest to the DL850/DL850V.</p> <p>GP-IB cable</p> <p>Use a shielded cable that is 3 m or less in length.</p> <p>USB cable</p> <p>Use a shielded cable that is 3 m or less in length, and attach a ferrite core<sup>4</sup> to the side of the cable closest to the DL850/DL850V.</p> <p>Ethernet cable</p> <p>Use a shielded cable that is 3 m or less in length, and attach a ferrite core<sup>4</sup> to the side of the cable closest to the DL850/DL850V.</p> <p>External clock input, external trigger input, external trigger output</p> <p>Use a shielded cable that is 3 m or less in length, and attach a ferrite core<sup>4</sup> to the side of the cable closest to the DL850/DL850V.</p> <p>IRIG cable</p> <p>Use a shielded cable that is 3 m or less in length, and attach a ferrite core<sup>4</sup> to the side of the cable closest to the DL850/DL850V.</p> <p>External HDD cable</p> <p>Use a shielded cable that is 3 m or less in length.</p> <p>Video signal output cable</p> <p>Use a shielded cable that is 3 m or less in length, and attach a ferrite core<sup>5</sup> to the side of the cable closest to the DL850/DL850V.</p> <p>External I/O cable</p> <p>Use a shielded cable that is 3 m or less in length, and attach a ferrite core<sup>4</sup> to the side of the cable closest to the DL850/DL850V.</p> <p>Probe power cable</p> <p>Use the dedicated cable, and wrap it once around a ferrite core<sup>4</sup> on the side of the cable closest to the DL850/DL850V.</p> <p>Example of wrapping the cable around once</p>  <p>Cable conditions (input module)</p> <p>Isolated probe 700929 (for the 701250, 701251, 701255, 701260, 701275, and 720210)</p> <p>Wrap the cable once around a ferrite core<sup>4</sup> on the side of the cable closest to the DL850/DL850V.</p> <p>Twisted pair cable for the 701261, 701262, and 701265</p> <p>Use a cable that is 3 m or less in length, and wrap the cable once around a ferrite core<sup>4</sup> on the side of the cable closest to the DL850/DL850V.</p> <p>Twisted pair cable for the 720220</p> <p>Use a cable that is 3 m or less in length, and wrap the cable once around a ferrite core<sup>6</sup> on the side of the cable closest to the DL850/DL850V.</p> <p>D-sub 9-pin shielded cable (for the 720240)</p> <p>Use a cable that is 3 m or less in length, and attach a ferrite core<sup>4</sup> to the side of the cable closest to the DL850/DL850V.</p>

Item	Specifications
	<p>Bridgeheads 701955 and 701956 (for the 701270) Use a cable that is 5 m or less in length, and attach a ferrite core<sup>4</sup> to the side of the cable closest to the DL850/DL850V.</p> <p>Bridgeheads 701957 and 701958 (for the 701271) Use a cable that is 5 m or less in length, and attach a ferrite core<sup>4</sup> to the side of the cable closest to the DL850/DL850V.</p> <p>Logic probe input cables 700986, 700987, 702911, and 702912 (for the 720230) Attach a ferrite core<sup>4</sup> to the side of the cable closest to the DL850/DL850V.</p>
Immunity	<p>Compliant standards EN61326-1 Table 2 (for industrial locations), EN61326-2-1 Approved (DL850/DL850V, 701250, 701251, 701255, 701260, 701261, 701262, 701265, 701270, 701271, 701275, 701280, 720210, 720220, 720230, 720240, 700986, 700987, 701955, 701956, 701957, 701958, 702911, 702912)</p> <p>Influence in the immunity environment (criteria A)</p> <p>Noise increase</p> <p>701250: <math>\leq \pm 20</math> mV (1:1 input, 5 mV/div conversion) 701251: <math>\leq \pm 3</math> mV (1:1 input, 1 mV/div conversion) 701255: <math>\leq \pm 25</math> mV (1:1 input, 5 mV/div conversion) 701260: <math>\leq \pm 30</math> mV (1:1 input, 20 mV/div conversion) 701261: <math>\leq \pm 3</math> mV (5 mV/div range conversion) 701262: <math>\leq \pm 3</math> mV (5 mV/div range conversion) 701265: <math>\leq \pm 0.05</math> mV (0.1 mV/div) 701270: <math>\leq \pm 100</math> <math>\mu</math>STR (<math>\pm 500</math> <math>\mu</math>V range, gauge factor = 2) 701271: <math>\leq \pm 100</math> <math>\mu</math>STR (<math>\pm 500</math> <math>\mu</math>V range, gauge factor = 2) 701275: <math>\leq \pm 6</math> mV (1:1 input, 5 mV/div range conversion) 701280: <math>\leq \pm 0.01</math> Hz (frequency, 0.1 Hz/div conversion) 720210: <math>\leq \pm 50</math> mV (1:1 input, 10 mV/div range conversion) 720220: <math>\leq \pm 20</math> mV (0.2 V/div range conversion) 720230: No bit errors 720240: No errors</p> <p>Test conditions</p> <p>701250: 10 MS/s, envelope mode, 50 mV/div, no input filter, with the tip of the probe (700929 (10:1)) shorted 701251: 1 MS/s, envelope mode, 10 mV/div, no input filter, with the tip of the probe (700929 (10:1)) shorted 701255: 10 MS/s, envelope mode, 50 mV/div, no input filter, with the tip of the probe (701940 (10:1)) shorted 701260: 100 kS/s, envelope mode, 0.2 V/div, no input filter, with the tip of the probe (700929 (10:1)) shorted 701261: 100 kS/s, envelope mode, 5 mV/div, no input filter, with the end of the cable shorted 701262: 100 kS/s, envelope mode, 5 mV/div, no input filter, with the end of the cable shorted 701265: 500 S/s, envelope mode, 0.1 mV/div, no input filter, with the end of the cable shorted 701270: 100 kS/s, envelope mode, 500 <math>\mu</math>STR, gauge factor: 2.0, no input filter 701955 bridge voltage: 2 V 701956 bridge voltage: 10 V 701271: 100 kS/s, envelope mode, 500 <math>\mu</math>STR, gauge factor: 2.0, no input filter 701957 bridge voltage: 2 V 701958 bridge voltage: 10 V 701275: 100 kS/s, envelope mode, 50 mV/div, no input filter, with the tip of the probe (700929 (10:1)) shorted 701280: 25 kS/s, envelope mode, Frequency, no input filter, with the tip of the probe shorted 720210: 100 M/s, envelope mode, 0.1 V/div, no input filter, with the tip of the probe (700929 (10:1)) shorted 720220: 12.5 kS/s, envelope mode, 0.2 V/div, no input filter, with the end of the cable shorted 720230: Logic probes 700986, 700987, 702911, and 702912, with the tips of the logic probes shorted 720240: Bit rate: 1 Msps, one shot operation</p>



## 6.12 General Specifications

Item	Specifications
	<p>Test items</p> <ol style="list-style-type: none"> <li>1. Electrostatic discharge Air discharge: <math>\pm 8</math> kV. Contact discharge: <math>\pm 4</math> kV. Criteria B.</li> <li>2. Radiated immunity 80 M to 1 GHz, 10 V/m, 1.4 G to 2 GHz, 3 V/m, 2 GHz to 4.0 GHz, 3 V/m, criteria A</li> <li>3. Conducted immunity 3 V, criteria A</li> <li>4. Fast transient/burst Power line: <math>\pm 2</math> kV. Signal line: <math>\pm 1</math> kV, criteria B</li> <li>5. Power frequency magnetic field Omitted, because the device does not exert considerable influence on the magnetic field</li> <li>6. Surge immunity <math>\pm 1</math> kV between lines, <math>\pm 2</math> kV common, criteria B</li> <li>7. Voltage dip and interruption 1 cycle, 100%, criteria B Other tests, criteria C</li> </ol> <p>Definitions of criteria</p> <p>Criteria A: During testing, "influence in the immunity environment" described above is met.</p> <p>Criteria B: The instrument continues to function and is controllable throughout testing. The instrument does not change operation modes, and data changes do not persist.</p> <p>Criteria C: Temporary losses of functionality (such as measurement stopping, etc.) are recovered from through the intervention of the operator.</p>
1	The overvoltage category (installation category) is a value used to define the transient overvoltage condition and includes the rated impulse withstand voltage. Category I applies to electric equipment whose power is supplied from a circuit that incorporates withstand voltage control. Category II applies to electrical equipment that is powered through a fixed installation, such as a switchboard.
2	Measurement Category II (CAT II) applies to electrical equipment that is powered through a fixed installation, such as a wall outlet wired to a distribution board, and to measurement performed on such wiring.
3	Pollution Degree applies to the degree of adhesion of a solid, liquid, or gas which deteriorates withstand voltage or surface resistivity. Pollution degree 2 applies to normal indoor atmospheres (with only non-conductive pollution).
4	TDK: ZCAT2035-0930A, YOKOGAWA part number: A1190MN
5	TDK: ZCAT3035-1330, YOKOGAWA part number: A1179MN
6	TDK: ZCAT1325-0530A, YOKOGAWA part number: A1181MN

## 6.13 Module Specifications

### High-Speed 10 MS/s, 12-Bit Isolation Module (701250) Specifications

Item	Specifications
Standard operating conditions	Temperature: 23°C±5°C Humidity: 20% to 80%RH After a 30-minute warm-up and after calibration
Effective measurement range	20 div (±10 div around 0 V, display range: 10 div, when Variable is OFF)
Number of input channels	2
Input coupling	AC, DC, and GND
Maximum sample rate	10 MS/s
Input format	Isolated unbalanced
Frequency characteristics <sup>1</sup>	(-3 dB point when sine wave of amplitude ±3 div is applied) DC to 3 MHz
Voltage-axis sensitivity setting	5 mV/div to 20 V/div (1-2-5 steps) (when using 1:1 probe attenuation)
Maximum input voltage (at a frequency of 1 kHz or less)	Combined with the 700929(10:1) or 701947(100:1): <sup>2</sup> 600 V (DC+ACpeak) Combined with the 701901+701954 (1:1): <sup>4</sup> 250 V (DC+ACpeak) Direct input or cable not complying with the safety standard: <sup>6</sup> 250 V (DC+ACpeak)
Maximum allowable common mode voltage (at a frequency of 1 kHz or less)	Working voltage of safety standard Combined with the 700929 (10:1) or 701947 (100:1): <sup>3</sup> 400 Vrms (CAT I) 300 Vrms (CAT II) or combined with the 701901+701954 (1:1): <sup>5</sup> Direct input or cable not complying with the safety standard: <sup>7</sup> 42 V (DC+ACpeak) (CAT I and CAT II, 30 Vrms)
Vertical (voltage) axis accuracy DC accuracy <sup>1</sup>	5 mV/div to 20 V/div: ±(0.5% of 10 div)
Input connector	BNC connector (isolated type)
Input impedance	1 MΩ ± 1%, approx. 35 pF
-3 dB point when AC coupled low frequency attenuation point	10 Hz or less (1 Hz or less when using the 700929, 0.1 Hz or less when using the 701947)
Common mode rejection ratio	80 dB (50/60 Hz) or more (typical <sup>8</sup> )
Residual noise level (Input section shorted)	±400 μV or ±0.06 div whichever is greater (Typical <sup>8</sup> )
Withstand voltage	1500 Vrms for 1 minute (across each terminal and earth) (60 Hz)
Allowable transient surge voltage (instantaneous)	±2100 Vpeak (across each input terminal and earth)
Insulation resistance	500 VDC, 10 MΩ or more (across each input terminal and earth)
A/D conversion resolution	12 bit (150 LSB/div)
Temperature coefficient	Zero point: 5 mV/div to 20 V/div: ±(0.05% of 10 div)/°C(Typical <sup>8</sup> ) Gain: ±(0.02% of 10 div)/°C(Typical <sup>8</sup> )
Bandwidth limit	Select from OFF, 500 kHz, 50 kHz, 5 kHz, and 500 Hz Cut-off characteristics: -18 dB/OCT (Typical <sup>8</sup> )
Probe attenuation setting	Voltage probe: 1:1, 10:1, 100:1, 1000:1 Current probe: 10 A:1 V (for the 700937/701933), 100 A: 1 V (for the 701930/701931)
Compatible probes/cables	Voltage probe: Recommended 700929 (10:1 safety probe).20 to 45 pF: For measuring 600 Vpeak or less 701947 (100:1 probe).15 to 45 pF: For measuring 600 Vpeak or less Current probe (power can be supplied from the DL850/DL850V. Option) 700937 (15 A), 701930 (150 A), 701931 (500 A), 701933 (30 A) High voltage differential probe (connect the GND cable provided with the probe to the DL850/DL850V case) 700924 (1000:1, 100:1/1400 Vpeak): For measuring 1400 Vpeak or less Connection cable (for high voltage 1:1) 701901 (isolated type BNC-safety alligator clip adapter ×2: For measuring 250 Vpeak or less), 701954 (alligator clip (dolphin type) red/black 2-piece set) is required separately Connection cable (for low voltage 1:1) 366926 (non-isolated type BNC-alligator clip ×2: For measuring low voltage less than or equal to 42 Vpeak)

1. Value measured under standard operating conditions.

## 6.13 Module Specifications

Combined with the 700929 or 701947

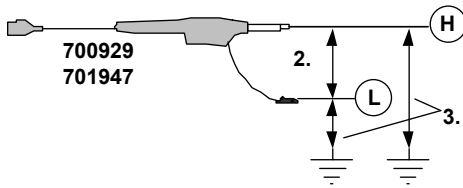

Combined with the 701901+701954

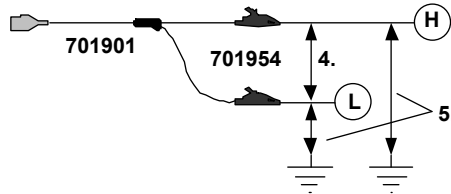

Direct input (cable not complying with the safety standard)

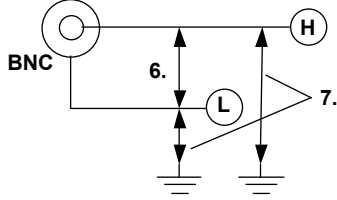

**Withstand voltage: 1500 Vrms for 1 minute**  
**Allowable transient surge voltage:  $\pm 2100$  Vpeak**  
(between earth and input)

8. The typical value is a representative or standard value. It is not strictly warranted.



### WARNING

- Do not apply input voltage exceeding the maximum input voltage, withstand voltage, or allowable surge voltage.
- To prevent the possibility of electric shock, be sure to furnish protective earth grounding of the DL850/DL850V.
- To prevent the possibility of electric shock, be sure to fasten the module screws. Otherwise, the electrical and mechanical protection functions will not be activated.
- Avoid continuous connection under an environment in which the surge voltage may occur.
- To prevent the possibility of electric shock, be sure to connect the GND lead of the differential probe (700924/700925) to the DL850/DL850V.

## High-Speed High-Resolution 1 MS/s, 16-Bit Isolation Module (701251) Specifications

Item	Specifications
Standard operating conditions	Temperature: 23°C±5°C Humidity: 20% to 80%RH After a 30-minute warm-up and after calibration
Effective measurement range	20 div (±10 div around 0 V, display range: 10 div, when Variable is OFF)
Number of input channels	2
Input coupling	AC, DC, and GND
Maximum sample rate	1 MS/s
Input format	Isolated unbalanced
Frequency characteristics <sup>1</sup> (-3 dB point when a sine wave of amplitude ±3 div is applied)	5 mV/div to 20 V/div: DC to 300 kHz 2 mV/div and 1mV/div: DC to 200 kHz
Voltage-axis sensitivity setting	1 mV/div to 20 V/div (1-2-5 steps) (when using 1:1 probe attenuation)
Maximum input voltage (at a frequency of 1 kHz or less)	Combined with the 700929(10:1) or 701947(100:1): <sup>2</sup> 600 V (DC+ACpeak) Combined with the 701901+701954 (1:1): <sup>4</sup> 140 V (DC+ACpeak) Direct input or cable not complying with the safety standard: <sup>6</sup> 140 V (DC+ACpeak)
Maximum allowable common mode voltage (at a frequency of 1 kHz or less)	Working voltage of safety standard Combined with the 700929 (10:1) or 701947 (100:1) <sup>3</sup> 400 Vrms (CAT I), 300 Vrms (CAT II) or combined with the 701901+701954 (1:1): <sup>5</sup> Direct input or cable not complying with the safety standard: <sup>7</sup> 42 V (DC+ACpeak) (CAT I and CAT II, 30 Vrms)
Vertical (voltage) axis accuracy DC accuracy <sup>1</sup>	5 mV/div to 20 V/div: ±(0.25% of 10 div) 2 mV/div: ±(0.3% of 10 div) 1 mV/div: ±(0.5% of 10 div)
Input connector	BNC connector (isolated type)
Input impedance	1 MΩ ± 1%, approx. 35 pF
-3 dB point when AC coupled low frequency attenuation point	1 Hz or less (0.1 Hz or less when using the 700929, 0.01 Hz or less when using the 701947)
Common mode rejection ratio	80 dB (50/60 Hz) or more (typical <sup>8</sup> )
Residual noise level (Input section shorted)	±100 μV or ±0.01 div whichever is greater (Typical <sup>8</sup> )
Withstand voltage	1500 Vrms for 1 minute (across each terminal and earth) (60 Hz)
Allowable transient surge voltage (instantaneous)	±2100 Vpeak (across each input terminal and earth)
Insulation resistance	500 VDC, 10 MΩ or more (across each input terminal and earth)
A/D conversion resolution	16 bit (2400 LSB/div)
Temperature coefficient	Zero point: 5 mV/div to 20 V/div: ±(0.02% of 10 div)/°C(Typical <sup>8</sup> ) 2 mV/div: ±(0.05% of 10 div)/°C(Typical <sup>8</sup> ) 1 mV/div: ±(0.10% of 10 div)/°C(Typical <sup>8</sup> ) Gain: 1 mV/div to 20 V/div: ±(0.02% of 10 div)/°C(Typical <sup>8</sup> )
Bandwidth limit	Select from OFF, 40 kHz, 4 kHz, and 400 Hz Cut-off characteristics: -12 dB/OCT (Typical <sup>8</sup> )
Probe attenuation setting	Voltage probe: 1:1, 10:1, 100:1, 1000:1 Current probe: 10 A:1 V (for the 700937/701933), 100 A: 1 V (for the 701930/701931)
Compatible probes/cables	Voltage probe: Recommended 700929 (10:1 safety probe).20 to 45 pF: For measuring 600 Vpeak or less 701947 (100:1 probe).15 to 45 pF: For measuring 600 Vpeak or less Current probe (power can be supplied from the DL850/DL850V. Option) 700937 (15 A), 701930 (150 A), 701931 (500 A), 701933 (30 A) High voltage differential probe (connect the GND cable provided with the probe to the DL850/DL850V case) 700924 (1000:1, 100:1/1400 Vpeak): For measuring 1400 Vpeak or less Connection cable (for high voltage 1:1) 701901 (isolated type BNC-safety alligator clip adapter ×2: For measuring 250 Vpeak or less), 701954 (alligator clip (dolphin type) red/black 2-piece set) is required separately Connection cable (for low voltage 1:1) 366926 (non-isolated type BNC-alligator clip ×2: For measuring low voltage less than or equal to 42 Vpeak)

1. Value measured under standard operating conditions.

## 6.13 Module Specifications

Combined with the 700929 or 701947

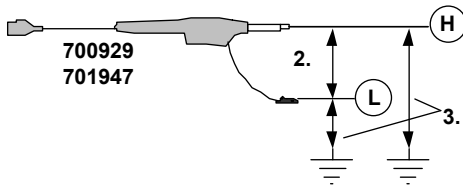

Combined with the 701901+701954

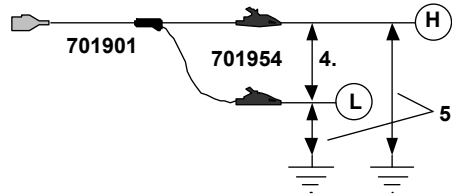

Direct input (cable not complying with the safety standard)

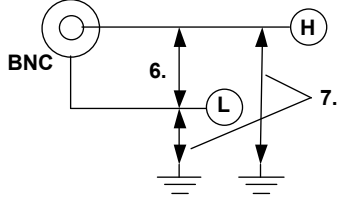

Withstand voltage: 1500 Vrms for 1 minute  
Allowable transient surge voltage:  $\pm 2100$  Vpeak  
(between earth and input)

8. The typical value is a representative or standard value. It is not strictly warranted.



### WARNING

- Do not apply input voltage exceeding the maximum input voltage, withstand voltage, or allowable surge voltage.
- To prevent the possibility of electric shock, be sure to furnish protective earth grounding of the DL850/DL850V.
- To prevent the possibility of electric shock, be sure to fasten the module screws. Otherwise, the electrical and mechanical protection functions will not be activated.
- Avoid continuous connection under an environment in which the surge voltage may occur.
- To prevent the possibility of electric shock, be sure to connect the GND lead of the differential probe (700924/700925) to the DL850/DL850V.

## High-Speed 10 MS/s, 12-Bit Non-Isolation Module (701255) Specifications

Item	Specifications
Standard operating conditions	Temperature: 23°C±5°C Humidity: 20% to 80%RH After a 30-minute warm-up and after calibration
Effective measurement range	20 div (±10 div around 0 V, display range: 10 div, when Variable is OFF)
Number of input channels	2
Input coupling	AC, DC, and GND
Maximum sample rate	10 MS/s
Input format	Non-isolated, unbalanced
Frequency characteristics <sup>1</sup>	(-3 dB point when sine wave of amplitude ±3 div is applied) DC to 3 MHz
Voltage-axis sensitivity setting	5 mV/div to 20 V/div (1-2-5 steps) (when using 1:1 probe attenuation)
Maximum input voltage (at a frequency of 1 kHz or less)	Combined with the 701940(10:1) <sup>2</sup> 600 V (DC+ACpeak) Direct input(1:1) <sup>3</sup> 250 V (DC+ACpeak)
Vertical (voltage) axis accuracy DC accuracy <sup>1</sup>	5 mV/div to 20 V/div: ±(0.5% of 10 div)
Input connector	BNC connector (metallic type)
Input impedance	1 MΩ ± 1%, approx. 35 pF
-3 dB point when AC coupled low frequency attenuation point	10 Hz or less (1 Hz or less when using the 701940)
Residual noise level (Input section shorted)	±400 μV or ±0.06 div whichever is greater (Typical <sup>4</sup> )
A/D conversion resolution	12 bit (150 LSB/div)
Temperature coefficient	Zero point: 5 mV/div to 20 V/div: ±(0.05% of 10 div)/°C(Typical <sup>4</sup> ) Gain: ±(0.02% of 10 div)/°C(Typical <sup>4</sup> )
Bandwidth limit	Select from OFF, 500 kHz, 50 kHz, 5 kHz, and 5400 Hz Cut-off characteristics: -18 dB/OCT (Typical <sup>4</sup> )
Probe attenuation setting	Voltage probe: 1:1, 10:1, 100:1, 1000:1 Current probe: 10 A:1 V (for the 700937/701933), 100 A: 1 V (for the 701930/701931)
Compatible probes/cables	Voltage probe (10:1 passive probe): Recommended 701940, 17 to 46 pF: For measuring 600 Vpeak or less Current probe (power can be supplied from the DL850/DL850V. Option) 700937 (15 A), 701930 (150 A), 701931 (500 A), 701933 (30 A) High voltage differential probe (connect the GND cable provided with the probe to the DL850/ DL850V case) 700924 (1000:1, 100:1/1400 Vpeak): For measuring 1400 Vpeak or less Connection cable (for low voltage 1:1) 366926 (non-isolated type BNC-alligator clip ×2: For measuring low voltage less than or equal to 42 Vpeak)

1. Value measured under standard operating conditions.

### Recommended:

Combined with the 10:1 passive probe  
(701940)

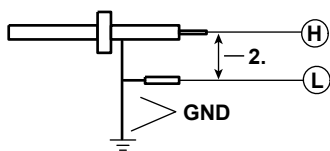

GND is connected to the case potential.

### Direct input

(When a cable that does not comply with  
the safety standard is connected)

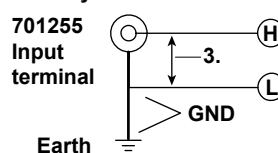

GND is connected to the case potential.

4. The typical value is a representative or standard value. It is not strictly warranted.



### **WARNING**

- Do not apply input voltage exceeding the maximum input voltage, withstand voltage, or allowable surge voltage.
  - To prevent the possibility of electric shock, be sure to furnish protective earth grounding of the DL850/DL850V.
  - To prevent the possibility of electric shock, be sure to fasten the module screws.
  - The module screws must be fastened for the module to function as a nonisolation module. In addition, all electrical and mechanical protection functions are activated only when the screws are fastened.
  - The maximum input voltage of the module is valid only when all the screws are fastened, and the protection path of the metal BNC is secured.
-

## High-Voltage 100 kS/s, 16-Bit Isolation Module (with RMS) (701260) Specifications

Item	Specifications
Standard operating conditions	Temperature: 23°C±5°C Humidity: 20% to 80%RH After a 30-minute warm-up and after calibration
Effective measurement range	20 div (±10 div around 0 V, display range: 10 div, when Variable is OFF)
Number of input channels	2
Input coupling	AC, DC, GND, AC-RMS, and DC-RMS
Maximum sample rate	100 kS/s
Input format	Isolated unbalanced
Frequency characteristics <sup>1</sup> (-3 dB point when a sine wave of amplitude ±3 div is applied)	Waveform observation mode: DC to 40 kHz RMS observation mode: DC, 40 Hz to 10 kHz
Voltage-axis sensitivity setting	20 mV/div to 200 V/div (1-2-5 steps) (when using 1:1 probe attenuation)
Maximum input voltage (at a frequency of 1 kHz or less)	Combined with the 700929(10:1) or 701947 (100:1): <sup>2</sup> 1000 V (DC+ACpeak) Combined with the 701901+701954 (1:1): <sup>5</sup> 850 V (DC+ACpeak) Direct input or cable not complying with the safety standard: <sup>8</sup> 850 V (DC+ACpeak)
Maximum allowable common mode voltage (at a frequency of 1 kHz or less)	Working voltage of safety standard Combined with the 700929 or 701947 (across probe tip H and earth <sup>3</sup> ): 1000 Vrms (CAT II) (across probe tip L and earth <sup>4</sup> ): 400 Vrms (CAT II) Combined with the 701901+701954 (1:1) (across tip H and earth <sup>6</sup> ): 700 Vrms (CAT II) (across tip L and earth <sup>7</sup> ): 400 Vrms (CAT II) Direct input or cable not complying with the safety standard: <sup>9</sup> 30 Vrms (42 VDC+ACpeak) (across the input terminal, H or L, and earth)
Vertical (voltage) axis accuracy DC accuracy <sup>1</sup>	Waveform observation mode DC accuracy ±(0.25% of 10 div) RMS observation mode DC accuracy ±(1.0% of 10 div) AC accuracy (when a sine wave is input) ±(1.5% of 10 div) At frequency of 40 Hz to 1 kHz AC accuracy (when the crest factor is 2 or less) ±(2.0% of 10 div) At frequency of 40 Hz to 1 kHz AC accuracy (when the crest factor is 3 or less) ±(3.0% of 10 div) At frequency of 40 Hz to 1 kHz
Input connector	BNC connector (isolated type)
Input impedance	1 MΩ ± 1%, approx. 35 pF
-3 dB point when AC coupled low frequency attenuation point	1 Hz or less (0.1 Hz or less when using the 700929, 0.01 Hz or less when using the 701947)
Common mode rejection ratio	80 dB (50/60 Hz) or more (typical <sup>10</sup> )
Residual noise level (Input section shorted)	±1 mV or ±0.02 div whichever is greater (Typical <sup>10</sup> )
Withstand voltage	3700 Vrms for 1 minute (across each terminal and earth) (60 Hz)
Allowable transient surge voltage (instantaneous)	±5200 Vpeak (across each input terminal and earth)
Insulation resistance	500 VDC, 10 MΩ or more (across each input terminal and earth)
A/D conversion resolution	16 bit (2400 LSB/div)
Temperature coefficient	Zero point: ±(0.02% of 10 div)/°C(Typical <sup>10</sup> ) Gain: ±(0.02% of 10 div)/°C(Typical <sup>10</sup> )
Response time (only when observing RMS)	Rising (0 to 90% of 10 div): 100 ms (typical <sup>10</sup> ) Falling (100 to 10% of 10 div): 250 ms (typical <sup>10</sup> )
Bandwidth limit	Select from OFF, 10 kHz, 1 kHz, and 100 Hz Cut-off characteristics: -12 dB/OCT (Typical <sup>10</sup> )
Probe attenuation setting	Voltage probe: 1:1, 10:1, 100:1, 1000:1 Current probe: 10 A:1 V (for the 700937/701933), 100 A: 1 V (for the 701930/701931)
Compatible probes/cables	Connection cable (for high voltage 1:1): Recommended 1 701901 (isolated type BNC-safety alligator clip adapter ×2: For measuring 850 V (DC+ACpeak) or less), 701954 (alligator clip (dolphin type) red/black 2-piece set) is required separately Voltage probe: Recommended 2 700929 (10:1 safety probe).20 to 45 pF: For measuring 1000 Vpeak or less 701947 (100:1 probe).15 to 45 pF: For measuring 1000 Vpeak or less Current probe (power can be supplied from the DL850/DL850V. Option) 700937 (15 A), 701930 (150 A), 701931 (500 A), 701933 (30 A)



## 6.13 Module Specifications

1. Value measured under standard operating conditions.

Combined with the 700929 or 701947

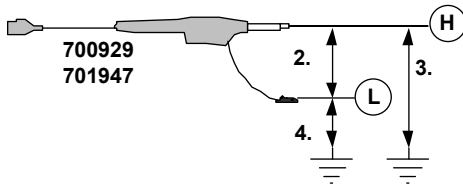

Combined with the 701901+701954

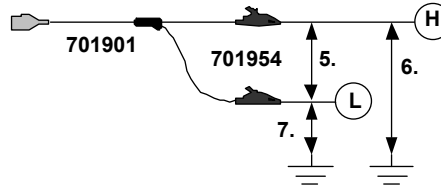

Direct input (cable not complying with the safety standard)

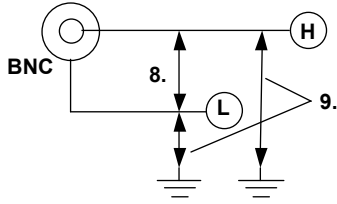

Withstand voltage: 3700 Vrms for 1 minute  
Allowable transient surge voltage:  $\pm 5200$  Vpeak  
(between earth and input)

10. The typical value is a representative or standard value. It is not strictly warranted.



### WARNING

- When applying high voltage using this module, use the 1:1 safety cable (combination of 701901 and 701954) or the isolated probe (700929 or 701947).
- The Measurement Category of the direct input of this module is 400 Vrms-CATII on the low side and 700 Vrms-CAT II on the high side. Use caution because the overvoltage category differs between the low and high sides.
- Do not apply input voltage exceeding the maximum input voltage, withstand voltage, or allowable surge voltage.
- To prevent the possibility of electric shock, be sure to furnish protective earth grounding of the DL850/DL850V.
- To prevent the possibility of electric shock, be sure to fasten the module screws. Otherwise, the electrical and mechanical protection functions will not be activated.
- Avoid continuous connection under an environment in which the surge voltage may occur.

## Universal (Voltage/Temp.) Module (701261) /Universal (Voltage/Temp.) Module (with AAF) (701262) Specifications

Item	Specifications																																						
Standard operating conditions	Temperature: 23°C±5°C Humidity: 20% to 80%RH After a 30-minute warm-up and after calibration																																						
Function	Temperature (thermocouple) or voltage measurement (switchable)																																						
Effective measurement range	Voltage measurement: 20 div (display range: 10 div)																																						
Number of input channels	2																																						
Input coupling	TC, DC, AC, and GND TC: Temperature (thermocouple) measurement DC: Voltage measurement (DC coupling) AC: Voltage measurement (AC coupling)																																						
Voltage measurement maximum sample rate	100 kS/s																																						
Temperature measurement data update rate	500 Hz																																						
Input format	Isolated unbalanced																																						
Measurement range/accuracy <sup>1</sup>	[Voltage measurement] Voltage sensitivity: 5 mV/div to 20 V/div (1-2-5 steps) Voltage accuracy: ±(0.25% of 10 div) [Temperature measurement] <sup>2</sup>																																						
	<table border="1"> <thead> <tr> <th>Type</th> <th>Measurement Range</th> <th>Accuracy</th> </tr> </thead> <tbody> <tr> <td>K</td> <td>-200 to 1300°C</td> <td>±(0.1% of reading + 1.5°C)</td> </tr> <tr> <td>E</td> <td>-200 to 800°C</td> <td rowspan="2">Except ±(0.2% of reading + 1.5°C) for -200°C to 0°C</td> </tr> <tr> <td>J</td> <td>-200 to 1100°C</td> </tr> <tr> <td>T</td> <td>-200 to 400°C</td> <td></td> </tr> <tr> <td>L</td> <td>-200 to 900°C</td> <td></td> </tr> <tr> <td>U</td> <td>-200 to 400°C</td> <td></td> </tr> <tr> <td>N</td> <td>0 to 1300°C</td> <td></td> </tr> <tr> <td>R</td> <td>0 to 1700°C</td> <td>±(0.1% of reading + 3°C)</td> </tr> <tr> <td>S</td> <td>0 to 1700°C</td> <td>Except, 0 to 200°C: ±8°C 200 to 800°C: ±5°C</td> </tr> <tr> <td>B</td> <td>0 to 1800°C</td> <td>±(0.1% of reading + 2°C) Except, 400 to 700°C: ±8°C Effective range is 400 to 1800°C</td> </tr> <tr> <td>W</td> <td>0 to 2300°C</td> <td>±(0.1% of reading + 3°C)</td> </tr> <tr> <td>Au7Fe<sup>3</sup></td> <td>0 to 300K</td> <td>0 to 50K: ±4K 50 to 300K: ±2.5K</td> </tr> </tbody> </table>	Type	Measurement Range	Accuracy	K	-200 to 1300°C	±(0.1% of reading + 1.5°C)	E	-200 to 800°C	Except ±(0.2% of reading + 1.5°C) for -200°C to 0°C	J	-200 to 1100°C	T	-200 to 400°C		L	-200 to 900°C		U	-200 to 400°C		N	0 to 1300°C		R	0 to 1700°C	±(0.1% of reading + 3°C)	S	0 to 1700°C	Except, 0 to 200°C: ±8°C 200 to 800°C: ±5°C	B	0 to 1800°C	±(0.1% of reading + 2°C) Except, 400 to 700°C: ±8°C Effective range is 400 to 1800°C	W	0 to 2300°C	±(0.1% of reading + 3°C)	Au7Fe <sup>3</sup>	0 to 300K	0 to 50K: ±4K 50 to 300K: ±2.5K
Type	Measurement Range	Accuracy																																					
K	-200 to 1300°C	±(0.1% of reading + 1.5°C)																																					
E	-200 to 800°C	Except ±(0.2% of reading + 1.5°C) for -200°C to 0°C																																					
J	-200 to 1100°C																																						
T	-200 to 400°C																																						
L	-200 to 900°C																																						
U	-200 to 400°C																																						
N	0 to 1300°C																																						
R	0 to 1700°C	±(0.1% of reading + 3°C)																																					
S	0 to 1700°C	Except, 0 to 200°C: ±8°C 200 to 800°C: ±5°C																																					
B	0 to 1800°C	±(0.1% of reading + 2°C) Except, 400 to 700°C: ±8°C Effective range is 400 to 1800°C																																					
W	0 to 2300°C	±(0.1% of reading + 3°C)																																					
Au7Fe <sup>3</sup>	0 to 300K	0 to 50K: ±4K 50 to 300K: ±2.5K																																					
Frequency characteristics <sup>1</sup> (-3 dB point when a sine wave of amplitude ±3 div is applied)	[Voltage measurement] DC to 40 kHz [Temperature measurement] DC to 100 Hz																																						
Maximum input voltage <sup>4</sup> (at a frequency of 1 kHz or less)	Both temperature and voltage input: 42 V (DC + ACpeak) (as a value that meets the safety standard) 150 V (DC + ACpeak) (maximum allowable voltage, as a value that does not damage the instrument when applied)																																						
Maximum allowable common mode voltage <sup>5</sup> (at a frequency of 1 kHz or less)	Both temperature and voltage input: 42 V (DC+ACpeak) (CAT I and CAT II, 30 Vrms)																																						
Vertical resolution	[Voltage measurement] During voltage input: 2400 LSB/div [Temperature measurement] When measuring temperature: 0.1°C																																						
-3 dB point when AC coupled low frequency attenuation point	[Voltage measurement] 0.5 Hz or less																																						
Input connector	Binding post																																						
Input impedance	Approx. 1 MΩ																																						
Common mode rejection ratio	[Voltage measurement] 80 dB (50/60 Hz) or more (typical <sup>6</sup> ) [Temperature measurement] 120 dB or more (50/60 Hz, with 2-Hz filter ON, signal source resistance of 500 Ω or less) (typical <sup>6</sup> )																																						
Residual noise level (Input section shorted)	[Voltage measurement] ±100 μV or ±0.01 div, whichever is greater (typical <sup>6</sup> )																																						
A/D conversion resolution	[Voltage measurement] 16 bits (2400 LSB/div)																																						

### 6.13 Module Specifications

Item	Specifications								
Temperature coefficient	[Voltage measurement] Zero point: $\pm(0.01\% \text{ of } 10 \text{ div})/^{\circ}\text{C}$ (typical <sup>6</sup> ) Gain: $\pm(0.02\% \text{ of } 10 \text{ div})/^{\circ}\text{C}$ (typical <sup>6</sup> )								
Reference junction compensation accuracy (when the input terminal temperature is balanced)	K, E, J, T, L, U, N: $\pm 1^{\circ}\text{C}$ R, S, B, W: $\pm 1.5^{\circ}\text{C}$ Au7Fe: $\pm 1\text{K}$								
Bandwidth limit	[Temperature measurement] (Digital filter + analog filter) Select from OFF, 30 Hz, 8 Hz, and 2 Hz + 150 Hz secondary analog filter [Voltage measurement] Select from OFF, AUTO, 4 kHz, 400 Hz, or 40 Hz. Cutoff characteristics: $-12 \text{ dB/OCT}$ (typical, <sup>6</sup> setting other than AUTO) Cutoff frequency (fc) when set to AUTO (701262 only)								
	<table border="1"> <thead> <tr> <th>Sample Rate</th> <th>Cutoff Frequency (fc)</th> </tr> </thead> <tbody> <tr> <td>100 kS/s or higher</td> <td>40 kHz</td> </tr> <tr> <td>100 S/s to 50 kS/s</td> <td>40% of the sample rate</td> </tr> <tr> <td>50 S/s or less</td> <td>20 Hz</td> </tr> </tbody> </table>	Sample Rate	Cutoff Frequency (fc)	100 kS/s or higher	40 kHz	100 S/s to 50 kS/s	40% of the sample rate	50 S/s or less	20 Hz
Sample Rate	Cutoff Frequency (fc)								
100 kS/s or higher	40 kHz								
100 S/s to 50 kS/s	40% of the sample rate								
50 S/s or less	20 Hz								

Cutoff characteristics for AUTO:  $-65 \text{ dB at } 2 \times \text{fc}$  (typical<sup>6</sup>)

Table of cutoff frequency characteristics of the anti-aliasing filter (AAF)

When the filter is set to Auto, the anti-aliasing filter and low-pass filter are automatically set according to the sample rate.

Sample Rate	AAF	Low-Pass Filter
100 kS/s	40 kHz	OFF
50 kS/s	20 kHz	OFF
20 kS/s	8 kHz	OFF
10 kS/s	4 kHz	4 kHz
5 kS/s	2 kHz	4 kHz
2 kS/s	800 Hz	4 kHz
1 kS/s	400 Hz	400 Hz
500 S/s	200 Hz	400 Hz
200 S/s	80 Hz	400 Hz
100 S/s	40 Hz	40 Hz
50 S/s	20 Hz	40 Hz
20 S/s to 5 S/s	20 Hz	40 Hz
2 S/s or less	20 Hz	40 Hz
Ext sample	40 kHz	OFF

- Value measured under standard operating conditions (section 19.11).
- Does not include the reference junction temperature compensation accuracy.
- This module supports Au7Fe with 0.07% metal content with respect to gold.

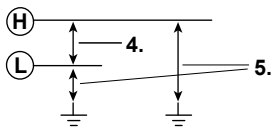

- Typical value represents a typical or average value. It is not strictly warranted.



#### WARNING

- Do not apply input voltage exceeding the maximum input voltage or allowable common mode input voltage.
- To prevent the possibility of electric shock, be sure to furnish protective earth grounding of the DL850/DL850V.
- To prevent the possibility of electric shock, be sure to fasten the module screws. Otherwise, the electrical and mechanical protection functions will not be activated.

## Temperature, High Precision Voltage Isolation Module (701265) Specifications

Item	Specifications	
Standard operating conditions	Temperature: 23°C±5°C Humidity: 20% to 80%RH After a 30-minute warm-up and after calibration	
Function	Temperature (thermocouple) or voltage measurement (switchable)	
Effective measurement range	Voltage measurement: 20 div (display range: 10 div)	
Number of input channels	2	
Input coupling	TC, DC, and GND TC: Temperature (thermocouple) measurement DC: Voltage measurement (DC coupling)	
Data update rate	500 Hz	
Measurement range/accuracy <sup>1</sup>	[Voltage measurement]	Voltage sensitivity: 100 µV/div to 10 V/div (1-2-5 steps) Voltage accuracy: ±(0.08% of 10 div + 2 µV)
	[Temperature measurement] <sup>2</sup>	
	<b>Type</b>	<b>Measurement Range Accuracy</b>
	K	-200 to 1300°C ±(0.1% of reading + 1.5°C)
	E	-200 to 800°C Except ±(0.2% of reading + 1.5°C)
	J	-200 to 1100°C for -200°C to 0°C
	T	-200 to 400°C
	L	-200 to 900°C
	U	-200 to 400°C
	N	0 to 1300°C
	R	0 to 1700°C ±(0.1% of reading + 3°C)
	S	0 to 1700°C Except, 0 to 200°C: ±8°C 200 to 800°C: ±5°C
	B	0 to 1800°C ±(0.1% of reading + 2°C) Except, 400 to 700°C: ±8°C Effective range is 400 to 1800°C
	W	0 to 2300°C ±(0.1% of reading + 3°C)
	Au7Fe <sup>3</sup>	0 to 300K 0 to 50K: ±4K 50 to 300K: ±2.5K
Frequency characteristics <sup>1</sup> (-3 dB point when a sine wave of amplitude ±3 div is applied)	[Voltage measurement]	DC to 100 Hz
	[Temperature measurement]	DC to 100 Hz
Maximum input voltage <sup>4</sup> (at a frequency of 1 kHz or less)	Both temperature and voltage input:	42 V (DC + ACpeak)
Maximum allowable common mode voltage <sup>5</sup> (at a frequency of 1 kHz or less)	Both temperature and voltage input:	42 V (DC+ACpeak) (CAT I and CAT II, 30 Vrms)
Vertical resolution	[Voltage measurement] During voltage input:	2400 LSB/div
	[Temperature measurement] When measuring temperature:	0.1°C
-3 dB point when AC coupled low frequency attenuation point	[Voltage measurement]	0.5 Hz or less
Input connector	Binding post	
Input impedance	Approx. 1 MΩ	
Common mode rejection ratio	[Voltage measurement]	80 dB (50/60 Hz) or more (typical <sup>6</sup> )
	[Temperature measurement]	120 dB or more (50/60 Hz, with 2-Hz filter ON, signal source resistance of 500 Ω or less) (typical <sup>6</sup> )
Residual noise level (Input section shorted)	[Voltage measurement]	±4 µV or ±0.01 div, whichever is greater (typical <sup>6</sup> )
A/D conversion resolution	[Voltage measurement]	16 bits (2400 LSB/div)
Temperature coefficient	[Voltage measurement]	Zero point: ±(0.01% of 10 div)/°C + 0.05µV/°C (typical <sup>6</sup> ) Gain ±(0.02% of 10 div)/°C (typical <sup>6</sup> )
Reference junction compensation accuracy (when the input terminal temperature is balanced)	K, E, J, T, L, U, N: R, S, B, W: Au7Fe:	±1°C ±1.5°C ±1K
Bandwidth limit (digital filter)	Select from OFF, 30 Hz, 8 Hz, and 2 Hz	

### 6.13 Module Specifications

Item	Specifications
Input bias current	20 nA or less The zero point appears to be offset when the input is open due to the effects of bias current on this module. However, this is not a malfunction. Connect the input to the object to be measured.

1. Value measured under standard operating conditions.
2. Does not include the reference junction temperature compensation accuracy.
3. This module supports Au7Fe with 0.07% metal content with respect to gold.

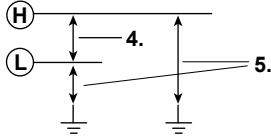

6. The typical value is a representative or standard value. It is not strictly warranted.



#### WARNING

- Do not apply input voltage exceeding the maximum input voltage or allowable common mode input voltage.
- To prevent the possibility of electric shock, be sure to furnish protective earth grounding of the DL850/DL850V.
- To prevent the possibility of electric shock, be sure to fasten the module screws. Otherwise, the electrical and mechanical protection functions will not be activated.

## Strain Module (NDIS) (701270) Specifications

Item	Specifications																												
Standard operating conditions	Temperature: 23°C±5°C Humidity: 20% to 80%RH After a 30-minute warm-up and after calibration and auto balance																												
Effective measurement range	-FS to +FS (set using upper and lower limits)																												
Number of input channels	2																												
Maximum sample rate	100 kS/s																												
Input format	DC bridge (auto balancing), balanced differential input, and isolated																												
Auto balance type	Electronic auto balance																												
Auto balance range	±10000 μSTR (1 gauge method)																												
Bridge voltage	Select from 2 V, 5 V, and 10 V.																												
Gauge resistance	120 Ω to 1000 Ω (bridge voltage: 2 V) 350 Ω to 1000 Ω (bridge voltage: 2 V, 5 V, and 10 V)																												
Gauge factor	1.90 to 2.20 (set in 0.01 steps)																												
Frequency characteristics <sup>1</sup> (-3 dB point when a sine wave of amplitude ±3 div is applied)	DC to 20 kHz																												
mV/V range support	Supports the strain gauge transducer unit system. mV/V range = 0.5×(μSTR range/1000)																												
Measurement range (FS) and measurement range	When using STR range <table border="1" data-bbox="571 857 1177 1059"> <thead> <tr> <th>Measurement Range (FS)</th> <th>Measurement Range</th> </tr> </thead> <tbody> <tr> <td>500 μSTR</td> <td>-500 μSTR to +500 μSTR</td> </tr> <tr> <td>1000 μSTR</td> <td>-1000 μSTR to +1000 μSTR</td> </tr> <tr> <td>2000 μSTR</td> <td>-2000 μSTR to +2000 μSTR</td> </tr> <tr> <td>5000 μSTR</td> <td>-5000 μSTR to +5000 μSTR</td> </tr> <tr> <td>10000 μSTR</td> <td>-10000 μSTR to +10000 μSTR</td> </tr> <tr> <td>20000 μSTR</td> <td>-20000 μSTR to +20000 μSTR</td> </tr> </tbody> </table> When using mV/V range <table border="1" data-bbox="571 1111 1161 1312"> <thead> <tr> <th>Measurement Range (FS)</th> <th>Measurement Range</th> </tr> </thead> <tbody> <tr> <td>0.25 mV/V</td> <td>-0.25 mV/V to +0.25 mV/V</td> </tr> <tr> <td>0.5 mV/V</td> <td>-0.5 mV/V to +0.5 mV/V</td> </tr> <tr> <td>1 mV/V</td> <td>-1 mV/V to +1 mV/V</td> </tr> <tr> <td>2.5 mV/V</td> <td>-2.5 mV/V to +2.5 mV/V</td> </tr> <tr> <td>5 mV/V</td> <td>-5 mV/V to +5 mV/V</td> </tr> <tr> <td>10 mV/V</td> <td>-10 mV/V to +10 mV/V</td> </tr> </tbody> </table>	Measurement Range (FS)	Measurement Range	500 μSTR	-500 μSTR to +500 μSTR	1000 μSTR	-1000 μSTR to +1000 μSTR	2000 μSTR	-2000 μSTR to +2000 μSTR	5000 μSTR	-5000 μSTR to +5000 μSTR	10000 μSTR	-10000 μSTR to +10000 μSTR	20000 μSTR	-20000 μSTR to +20000 μSTR	Measurement Range (FS)	Measurement Range	0.25 mV/V	-0.25 mV/V to +0.25 mV/V	0.5 mV/V	-0.5 mV/V to +0.5 mV/V	1 mV/V	-1 mV/V to +1 mV/V	2.5 mV/V	-2.5 mV/V to +2.5 mV/V	5 mV/V	-5 mV/V to +5 mV/V	10 mV/V	-10 mV/V to +10 mV/V
Measurement Range (FS)	Measurement Range																												
500 μSTR	-500 μSTR to +500 μSTR																												
1000 μSTR	-1000 μSTR to +1000 μSTR																												
2000 μSTR	-2000 μSTR to +2000 μSTR																												
5000 μSTR	-5000 μSTR to +5000 μSTR																												
10000 μSTR	-10000 μSTR to +10000 μSTR																												
20000 μSTR	-20000 μSTR to +20000 μSTR																												
Measurement Range (FS)	Measurement Range																												
0.25 mV/V	-0.25 mV/V to +0.25 mV/V																												
0.5 mV/V	-0.5 mV/V to +0.5 mV/V																												
1 mV/V	-1 mV/V to +1 mV/V																												
2.5 mV/V	-2.5 mV/V to +2.5 mV/V																												
5 mV/V	-5 mV/V to +5 mV/V																												
10 mV/V	-10 mV/V to +10 mV/V																												
DC accuracy <sup>1</sup>	±(0.5% of FS + 5 μSTR)																												
Maximum input voltage (at a frequency of 1 kHz or less)	Between Input+ and Input- 10 V (DC+ACpeak)																												
Maximum allowable common mode voltage (at a frequency of 1 kHz or less)	Between each terminal and earth ground 42 V (DC+ACpeak) (CAT I and CAT II, 30 Vrms)																												
Input connector	NDIS connector (Recommended by JSNDI (The Japanese Society for Non-destructive Inspection))																												
Common mode rejection ratio	80 dB (50/60 Hz) or more (Typical <sup>2</sup> )																												
A/D conversion resolution	16 bit (4800 LSB/div: Upper = +FS, Lower = -FS)																												
Temperature coe	Zero point: ±5 μSTR/°C (Typical <sup>2</sup> ) Gain: ±(0.02% of FS)/°C (Typical <sup>2</sup> )																												
Bandwidth limit	Select from OFF, 1 kHz, 100 Hz, and 10 Hz Cutoff characteristics: -12 dB/OCT (Typical <sup>2</sup> )																												
Function	mV/V support. Supports the strain gauge transducer unit system.																												
Standard accessories	NDIS connector (for external connection: PRC03-12A10-7M10.5 by Tajimi) A1002JC: 2 pieces																												
Compatible accessories (sold separately)	Recommended bridge head 701955 (NDIS 120 Ω, enhanced shield version, comes with a 5-m cable) Recommended bridge head 701956 (NDIS 350 Ω, enhanced shield version, comes with a 5-m cable))																												

## 6.13 Module Specifications

Item	Specifications
Precautions	<ul style="list-style-type: none"> <li>Highly sensitive measurements are made in the <math>\mu\text{V}</math> level in strain measurements. Therefore, take measures against noise at the strain sensor perimeter, bridge head, and cable wiring.</li> <li>Depending on the noise environment, an error may result in the balance. Check the influence before making measurements.</li> <li>The bridge head specified by YOKOGAWA has high noise resistance.</li> <li>Some of the strain gauge sensors and bridge heads made by other manufacturers do not have sensing wires connected. (No such problems with bridge heads made by YOKOGAWA.) If such products are used, an error may result in the bridge voltage leading to measurement errors, because sensing does not work effectively. If possible, it is desirable that sensing be done very close to the bridge. However, if this is not possible, use the NDIS conversion cable (DV450-001) that is sold separately by YOKOGAWA. Outline specifications of the DV450-001: Sensing cable, NDIS male-female, 30 cm in length, insert it as close to the bridge as possible</li> <li>The connector shell is connected to the case potential.</li> <li>When a bridge head (701955 or 701956) is used, the connector shell, cable shield, and the bridge head case are all connected to the case potential of the DL850/DL850V.</li> <li>When a bridge head (701955 or 701956) is used, the floating GND is connected to the bridge head case inside the bridge head.</li> <li>Be sure to execute balancing again when you change the range or the bridge voltage.</li> </ul>

- Value measured under standard operating conditions.
- The typical value is a representative or standard value. It is not strictly warranted.

### Module front View

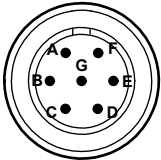

- A: Bridge+ (positive bridge voltage)
- B: Input- (negative measurement signal)
- C: Bridge- (negative bridge voltage)
- D: Input+ (positive measurement signal)
- E: Floating common
- F: Sense+ (positive bridge voltage sensing)
- G: Sense- (positive bridge voltage sensing)

The connector shell is connected to the case potential.



### WARNING

- Do not apply input voltage exceeding the maximum input voltage or allowable common mode input voltage.
- To prevent the possibility of electric shock, be sure to furnish protective earth grounding of the DL850/DL850V.
- To prevent the possibility of electric shock, be sure to fasten the module screws. Otherwise, the electrical and mechanical protection functions will not be activated.
- Avoid continuous connection under an environment in which the surge voltage may occur.

## Strain Module (DSUB, Shunt-Cal) (701271) Specifications

Item	Specifications																												
Standard operating conditions	Temperature: 23°C±5°C Humidity: 20% to 80%RH After a 30-minute warm-up and after calibration and auto balance																												
Effective measurement range	-FS to +FS (set using upper and lower limits)																												
Number of input channels	2																												
Maximum sample rate	100 kS/s																												
Input format	DC bridge (auto balancing), balanced differential input, and isolated																												
Auto balance type	Electronic auto balance																												
Auto balance range	±10000 µSTR (1 gauge method)																												
Bridge voltage	Select from 2 V, 5 V, and 10 V.																												
Gauge resistance	120 Ω to 1000 Ω (bridge voltage: 2 V) 350 Ω to 1000 Ω (bridge voltage: 2 V, 5 V, and 10 V)																												
Gauge factor	1.90 to 2.20 (set in 0.01 steps)																												
Frequency characteristics <sup>1</sup> (-3 dB point when a sine wave of amplitude ±3 div is applied)	DC to 20 kHz																												
mV/V range support	Supports the strain gauge transducer unit system. mV/V range = 0.5×(µSTR range/1000)																												
Measurement range (FS) and measurement range	When using STR range <table border="1" data-bbox="582 853 1315 1059"> <thead> <tr> <th>Measurement Range (FS)</th> <th>Measurement Range</th> </tr> </thead> <tbody> <tr> <td>500 µSTR</td> <td>-500 µSTR to +500 µSTR</td> </tr> <tr> <td>1000 µSTR</td> <td>-1000 µSTR to +1000 µSTR</td> </tr> <tr> <td>2000 µSTR</td> <td>-2000 µSTR to +2000 µSTR</td> </tr> <tr> <td>5000 µSTR</td> <td>-5000 µSTR to +5000 µSTR</td> </tr> <tr> <td>10000 µSTR</td> <td>-10000 µSTR to +10000 µSTR</td> </tr> <tr> <td>20000 µSTR</td> <td>-20000 µSTR to +20000 µSTR</td> </tr> </tbody> </table> When using mV/V range <table border="1" data-bbox="582 1111 1315 1317"> <thead> <tr> <th>Measurement Range (FS)</th> <th>Measurement Range</th> </tr> </thead> <tbody> <tr> <td>0.25 mV/V</td> <td>-0.25 mV/V to +0.25 mV/V</td> </tr> <tr> <td>0.5 mV/V</td> <td>-0.5 mV/V to +0.5 mV/V</td> </tr> <tr> <td>1 mV/V</td> <td>-1 mV/V to +1 mV/V</td> </tr> <tr> <td>2.5 mV/V</td> <td>-2.5 mV/V to +2.5 mV/V</td> </tr> <tr> <td>5 mV/V</td> <td>-5 mV/V to +5 mV/V</td> </tr> <tr> <td>10 mV/V</td> <td>-10 mV/V to +10 mV/V</td> </tr> </tbody> </table>	Measurement Range (FS)	Measurement Range	500 µSTR	-500 µSTR to +500 µSTR	1000 µSTR	-1000 µSTR to +1000 µSTR	2000 µSTR	-2000 µSTR to +2000 µSTR	5000 µSTR	-5000 µSTR to +5000 µSTR	10000 µSTR	-10000 µSTR to +10000 µSTR	20000 µSTR	-20000 µSTR to +20000 µSTR	Measurement Range (FS)	Measurement Range	0.25 mV/V	-0.25 mV/V to +0.25 mV/V	0.5 mV/V	-0.5 mV/V to +0.5 mV/V	1 mV/V	-1 mV/V to +1 mV/V	2.5 mV/V	-2.5 mV/V to +2.5 mV/V	5 mV/V	-5 mV/V to +5 mV/V	10 mV/V	-10 mV/V to +10 mV/V
Measurement Range (FS)	Measurement Range																												
500 µSTR	-500 µSTR to +500 µSTR																												
1000 µSTR	-1000 µSTR to +1000 µSTR																												
2000 µSTR	-2000 µSTR to +2000 µSTR																												
5000 µSTR	-5000 µSTR to +5000 µSTR																												
10000 µSTR	-10000 µSTR to +10000 µSTR																												
20000 µSTR	-20000 µSTR to +20000 µSTR																												
Measurement Range (FS)	Measurement Range																												
0.25 mV/V	-0.25 mV/V to +0.25 mV/V																												
0.5 mV/V	-0.5 mV/V to +0.5 mV/V																												
1 mV/V	-1 mV/V to +1 mV/V																												
2.5 mV/V	-2.5 mV/V to +2.5 mV/V																												
5 mV/V	-5 mV/V to +5 mV/V																												
10 mV/V	-10 mV/V to +10 mV/V																												
DC accuracy <sup>1</sup>	±(0.5% of FS+5 µSTR)																												
Maximum input voltage (at a frequency of 1 kHz or less)	Between Input+ and Input- 10 V (DC+ACpeak)																												
Maximum allowable common mode voltage (at a frequency of 1 kHz or less)	Between each terminal and earth ground 42 V (DC+ACpeak) (CAT I and CAT II, 30 Vrms)																												
Input connector	9-pin D-Sub connector (female)																												
Common mode rejection ratio	80 dB (50/60 Hz) or more (Typical <sup>2</sup> )																												
A/D conversion resolution	16 bit (4800 LSB/div: Upper = +FS, Lower = -FS)																												
Temperature coe	Zero point: ±5 µSTR/°C (Typical <sup>2</sup> ) Gain: ±(0.02% of FS)/°C (Typical <sup>2</sup> )																												
Bandwidth limit	Select from OFF, 1 kHz, 100 Hz, and 10 Hz Cutoff characteristics: -12 dB/OCT (Typical <sup>2</sup> )																												
Function	mV/V support. Supports the strain gauge transducer unit system. Shunt calibration support. Built-in shunt calibration relay (1 gauge method).																												
Standard accessories	Connector shell set for soldering A1520JD (9-pin D-Sub): 2 pieces, A1618JD (connector shell): 2 pieces																												
Compatible accessories (sold separately)	Recommended bridge head 701957 (D-Sub 120 Ω, shunt-Cal, comes with a 5-m cable) Recommended bridge head 701958 (D-Sub 350 Ω, shunt-Cal, comes with a 5-m cable)																												



## 6.13 Module Specifications

Item	Specifications
Precautions	<ul style="list-style-type: none"> <li>Highly sensitive measurements are made in the <math>\mu V</math> level in strain measurements. Therefore, take measures against noise at the strain sensor perimeter, bridge head, and cable wiring.</li> <li>Depending on the noise environment, an error may result in the balance. Check the influence before making measurements.</li> <li>The bridge head specified by YOKOGAWA has high noise resistance.</li> <li>When executing shunt calibration, be sure to calculate the shunt resistance in advance, and execute it in a range so that the measured values do not exceed the range even when the shunt resistance is ON.</li> <li>Some of the strain gauge sensors and bridge heads made by other manufacturers do not have sensing wires connected. (No such problems with bridge heads made by YOKOGAWA.) If such products are used, an error may result in the bridge voltage leading to measurement errors, because sensing does not work effectively. Perform sensing as close to the bridge head as possible. (There is no conversion cable for sensing on D-Sub connector types.)</li> <li>The connector shell is connected to the case potential.</li> <li>When a bridge head (701957 or 701958) is used, the connector shell, cable shield, and the bridge head case are all connected to the case potential of the DL850/DL850V.</li> <li>When a bridge head (701957 or 701958) is used, the floating GND is connected to the bridge head case inside the bridge head.</li> <li>Be sure to execute balancing again when you change the range or the bridge voltage.</li> </ul>

- Value measured under standard operating conditions.
- The typical value is a representative or standard value. It is not strictly warranted.

### Module front View

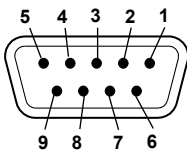

- 1: Floating common
- 2: Sense- (positive bridge voltage sensing)
- 3: Shuntcal- (negative shunt signal)
- 4: Shuntcal+ (positive shunt signal)
- 5: Sense+ (positive bridge voltage sensing)
- 6: Bridge- (negative bridge voltage)
- 7: Input- (negative measurement signal)
- 8: Input+ (positive measurement signal)
- 9: Bridge+ (positive bridge voltage)



### WARNING

- Do not apply input voltage exceeding the maximum input voltage or allowable common mode input voltage.
- To prevent the possibility of electric shock, be sure to furnish protective earth grounding of the DL850/DL850V.
- To prevent the possibility of electric shock, be sure to fasten the module screws. Otherwise, the electrical and mechanical protection functions will not be activated.
- Avoid continuous connection under an environment in which the surge voltage may occur.

## Acceleration/Voltage Module (with AAF) (701275) Specifications

Item	Specifications
Standard operating conditions	Temperature: 23°C±5°C Humidity: 20% to 80%RH After a 30-minute warm-up and after calibration
Effective measurement range	20 div (display range: 10 div)
Number of input channels	2
Input coupling	AC, DC, GND, ACCL (acceleration), and GND
Maximum sample rate	100 kS/s
Input format	Isolated unbalanced
Frequency characteristics <sup>1</sup> (-3 dB point when a sine wave of amplitude ±3 div is applied)	Waveform observation mode: DC to 40 kHz Acceleration measurement mode: 0.4 Hz to 40 kHz
Voltage-axis sensitivity setting	5 mV/div to 10 V/div (1-2-5 steps) (when using 1:1 probe attenuation) Acceleration (±5 V = ×1 range): ×0.1 to ×1 to ×100 (in 1-2-5 steps)
Maximum input voltage (at a frequency of 1 kHz or less)	42 V (DC+Acpeak) <sup>2</sup>
Maximum allowable common mode voltage (at a frequency of 1 kHz or less)	Working voltage of safety standard 30 Vrms (CAT and CAT II) <sup>3</sup>
Vertical (voltage) axis accuracy DC accuracy <sup>1</sup>	Waveform measurement mode DC accuracy: ±(0.25% of 10 div) Acceleration measurement mode: ±(0.5% of 10 div) at 1 kHz
Input connector	Metal BNC connector
Input impedance	1 MΩ±1%, approx. 35 pF
-3 dB point when AC coupled low frequency attenuation point	0.4 Hz or less (0.04 Hz or less when using the 701940) (Typical <sup>4</sup> )
Common mode rejection ratio	80 dB (50/60 Hz) or more (Typical <sup>4</sup> )
Residual noise level (Input section shorted)	±100 μV or ±0.01 div, whichever is greater (Typical <sup>4</sup> )
A/D conversion resolution	16 bits (2400LSB/div)
Temperature coefficient	When in waveform measurement mode (excluding AUTO filter) Zero point: ±(0.02% of 10 div)/°C (Typical <sup>4</sup> ) Gain: ±(0.02% of 10 div)/°C (Typical <sup>4</sup> )
Response time (only when observing RMS)	Select from OFF, Auto, 4 KHz, 400 Hz, and 40 Hz Cutoff characteristics: -12 dB/OCT (typical <sup>4</sup> , excluding AUTO) Cutoff frequency (fc) when set to AUTO Sample rate of 100 kHz or higher: fc = 40 kHz Sample rate of 100 Hz to 50 kHz: fc = 40% of the sampling rate Sample rate of 50 Hz or less: fc = 20 Hz Cutoff characteristics when set to AUTO: -65 dB at 2×fc (typical <sup>4</sup> )
Bandwidth limit	Voltage probe 1:1, 10:1, 100:1, or 1000:1 Current probe 10 A:1 V (for the 700937/701933), 100 A:1 V (for the 701930/701931)
Probe attenuation setting	Connection cable (for low voltage 1:1) 366926 (non-isolated type BNC-alligator clip × 2: For measuring low voltage less than or equal to 42 Vpeak) Voltage probe (10:1 passive probe) 701940 17 to 46 pF: For measuring 600 V (DC+ACpeak) or less Current probe (power can be supplied from the DL850/DL850V) 700937 (15 A), 701930 (150 A), 701931 (500 A), 701933 (30 A)
Sensor supply current (voltage)	OFF/4 mA ± 10%(approx. 22 VDC)
Applicable acceleration sensor	Built-in amplifier type Kistler Instrument Corporation: Piezotron, PCB Piezotronics Incorporated: ICP, ENDEVCO Corporation: ISOTRON, etc.

## 6.13 Module Specifications

Item	Specifications																																													
Table of Cutoff Frequency Characteristics of the Anti-Aliasing Filter (AAF)	When the filter is set to Auto, the anti-aliasing filter and low-pass filter are automatically set according to the sample rate.																																													
	<table border="1"> <thead> <tr> <th>Sample Rate</th> <th>AAF</th> <th>Low-pass filter</th> </tr> </thead> <tbody> <tr> <td>100 kS/s</td> <td>40 kHz</td> <td>OFF</td> </tr> <tr> <td>50 kS/s</td> <td>20 kHz</td> <td>OFF</td> </tr> <tr> <td>20 kS/s</td> <td>8 kHz</td> <td>OFF</td> </tr> <tr> <td>10 kS/s</td> <td>4 kHz</td> <td>4 kHz</td> </tr> <tr> <td>5 kS/s</td> <td>2 kHz</td> <td>4 kHz</td> </tr> <tr> <td>2 kS/s</td> <td>800 Hz</td> <td>4 kHz</td> </tr> <tr> <td>1 kS/s</td> <td>400 Hz</td> <td>400 Hz</td> </tr> <tr> <td>500 S/s</td> <td>200 Hz</td> <td>400 Hz</td> </tr> <tr> <td>200 S/s</td> <td>80 Hz</td> <td>400 Hz</td> </tr> <tr> <td>100 S/s</td> <td>40 Hz</td> <td>40 Hz</td> </tr> <tr> <td>50 S/s</td> <td>20 Hz</td> <td>40 Hz</td> </tr> <tr> <td>20 S/s to 5 S/s</td> <td>20 Hz</td> <td>40 Hz</td> </tr> <tr> <td>2 S/s or less</td> <td>20 Hz</td> <td>40 Hz</td> </tr> <tr> <td>Ext sample</td> <td>40 kHz</td> <td>OFF</td> </tr> </tbody> </table>	Sample Rate	AAF	Low-pass filter	100 kS/s	40 kHz	OFF	50 kS/s	20 kHz	OFF	20 kS/s	8 kHz	OFF	10 kS/s	4 kHz	4 kHz	5 kS/s	2 kHz	4 kHz	2 kS/s	800 Hz	4 kHz	1 kS/s	400 Hz	400 Hz	500 S/s	200 Hz	400 Hz	200 S/s	80 Hz	400 Hz	100 S/s	40 Hz	40 Hz	50 S/s	20 Hz	40 Hz	20 S/s to 5 S/s	20 Hz	40 Hz	2 S/s or less	20 Hz	40 Hz	Ext sample	40 kHz	OFF
Sample Rate	AAF	Low-pass filter																																												
100 kS/s	40 kHz	OFF																																												
50 kS/s	20 kHz	OFF																																												
20 kS/s	8 kHz	OFF																																												
10 kS/s	4 kHz	4 kHz																																												
5 kS/s	2 kHz	4 kHz																																												
2 kS/s	800 Hz	4 kHz																																												
1 kS/s	400 Hz	400 Hz																																												
500 S/s	200 Hz	400 Hz																																												
200 S/s	80 Hz	400 Hz																																												
100 S/s	40 Hz	40 Hz																																												
50 S/s	20 Hz	40 Hz																																												
20 S/s to 5 S/s	20 Hz	40 Hz																																												
2 S/s or less	20 Hz	40 Hz																																												
Ext sample	40 kHz	OFF																																												

1. Value measured under standard operating conditions.

Combined with the 10:1 passive probe (701940)

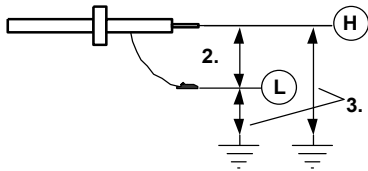

Direct input (cable not complying with the safety standard)

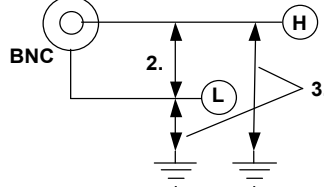

4. The typical value is a representative or standard value. It is not strictly warranted.



### WARNING

- Do not apply input voltage exceeding the maximum input voltage or allowable common mode input voltage.
- To prevent the possibility of electric shock, be sure to furnish protective earth grounding of the DL850/DL850V.
- To prevent the possibility of electric shock, be sure to fasten the module screws. Otherwise, the electrical and mechanical protection functions will not be activated.
- Avoid continuous connection under an environment in which the surge voltage may occur.

## Frequency Module (701280) Specifications

Item	Specifications
Standard operating conditions	Temperature: 23°C±5°C Humidity: 20% to 80%RH After a 30-minute warm-up and after calibration
Measurement function	Frequency, RPMs, RPSs, period, duty cycle, power supply frequency, pulse width, pulse integration, and velocity
Effective measurement range	20 div (display range: 10 div)
Number of input channels	2
Data update rate	25 kHz (40 μs)
Output delay time	Up to 2 computation periods
Input format	Isolated unbalanced
Input connector	Metal BNC connector
Maximum input voltage	Module only (when 1:1 cable is connected, across input terminals H and L): 42 V (DC+ACpeak) <sup>4</sup> Combined with the 700929(10:1) or 701947(100:1) (across the probe tips, H and L3): 420 V (DC+ACpeak) <sup>2</sup>
Maximum allowable common mode voltage	Working voltage of safety standard Module only (when 1:1 cable is connected, across input terminal L and earth) 30 Vrms (CAT I and CAT II) <sup>5</sup> Combined with the 700929 (10:1) or 701947 (100:1) (across probe tip H or L and earth) 300 Vrms (CAT I and CAT II) <sup>3</sup>
Insulation resistance	500 VDC, 10 MΩ or more (across each input terminal and earth))
Minimum measurement resolution	50 ns
Measured data resolution	16 bits (2400 LSB/div)
Measurement accuracy <sup>1</sup>	<ul style="list-style-type: none"> <li>• <b>When in frequency, RPM, RPS, or velocity measurement mode<sup>6</sup></b> Measurement accuracy is specified according to the measurement range and input frequency [Definition of measurement accuracy] v±(0.05% of 10 div + accuracy dependent on the input frequency) [Accuracy dependent on the input frequency] When input frequency is 2 kHz or less: 0.05% of the input frequency + 0.001 Hz Input frequency of 2 kHz to 10 kHz: 0.1% of the input frequency Input frequency of 10 kHz to 20 kHz: 0.3% of the input frequency Input frequency of 20 kHz or higher: 0.5% of the input frequency</li> <li>• <b>When in power supply frequency mode<sup>7</sup></b> When the center frequency is 50/60 Hz: ±0.03 Hz (0.01 Hz resolution) When the center frequency is 400 Hz: ±0.3 Hz (0.01 Hz resolution) (Input set to AC100 V or AC200 V with sine wave input)</li> <li>• <b>When in period measurement mode<sup>6</sup></b> Measurement accuracy is specified according to the measurement range and input period [Definition of measurement accuracy] ±(0.05% of 10 div + accuracy dependent on the input period) [Accuracy dependent on the input period] Input period of 500 μs or greater: 0.05% of the input period Input period of 100 μs to 500 μs: 0.1% of the input period Input period of 50 μs to 100 μs: 0.3% of the input period Input period of 50 μs or less: 0.5% of the input period + 0.1 μs</li> <li>• <b>When in duty cycle measurement mode<sup>8</sup></b> Dependent on the input frequency Input frequency of 1 kHz or less: ±0.1% Input frequency of 1 kHz to 10 kHz: ±0.2% Input frequency of 10 kHz to 50 kHz: ±1.0% Input frequency of 50 kHz to 100 kHz: ±2.0% Input frequency of 100 kHz to 200 kHz: ±4.0%</li> <li>• <b>When in pulse width measurement mode<sup>8</sup></b> Measurement accuracy is specified according to the measurement range and input pulse width [Definition of measurement accuracy] ±(0.05% of 10 div + accuracy dependent on the input pulse width) [Accuracy dependent on the input pulse width] Input pulse width of 500 μs or greater: 0.05% of the input pulse width Input pulse width of 100 μs to 500 μs: 0.1% of the input pulse width Input pulse width of 50 μs to 100 μs: 0.3% of the input pulse width Input pulse width of 50 μs or less: 0.5% of the input pulse width + 0.1 μs</li> </ul>

### 6.13 Module Specifications

Item	Specifications
Input voltage range ( $\pm$ FS)	When using 1:1 probe attenuation: $\pm 1$ V, $\pm 2$ V, $\pm 5$ V, $\pm 10$ V, $\pm 20$ V, $\pm 50$ V ( $\pm$ FS)
Input impedance	1 M $\Omega$ $\pm$ 1 approx. 35 pF Pull-up function: 4.7 k $\Omega$ , approx. 5 V (pull-up can be turned ON only when the input is set to Pull-Up 5 V)
Input coupling settings	AC, DC
Probe attenuation setting	10:1, 1:1
Minimum voltage width for pulse detection	200 mV <sub>P-P</sub>
Bandwidth limit	Select from Full, 100 kHz, 10 kHz, 1 kHz, and 100 Hz Cutoff characteristics: -12 dB/OCT (typical <sup>9</sup> )
Threshold	Set within the FS of the voltage range. Set in units of 1% of the FS.
Hysteresis	Select $\pm 1\%$ , $\pm 2.5\%$ , or $\pm 5\%$ of the FS of the voltage range
Preset function	Logic (5 V/3 V/12 V/24 V), electromagnetic pickup, zero crossing, pull-up, AC100 V, AC200 V, and user-defined
Slope selection	Select rising or falling
Lower -3 dB point when AC coupled	0.5 Hz or less (0.05 Hz or less when using the 700929, 0.005 Hz or less when using the 701947) (typical <sup>9</sup> )
Chatter elimination function	OFF or 1 to 1000 ms (1 ms resolution) Eliminates the chatter that occurs such when the contact input is turned ON/OFF. Can discard the signal changes over the specified interval.
Input status indication function	Input status indication through the LEDs of each channel function When in operation: Illuminates in green when pulse input is detected When overdriven: Illuminates in red when the input voltage exceeds the range
Compatible probes/cables	Connection cable (1:1): Recommended 1 366926 Voltage probe: Recommended 2 700929 (10:1 safety probe) .20 to 45 pF: For measuring 1000 V (DC+ACpeak) or less 701947 (100:1 probe) .15 to 45 pF: For measuring 1000 V (DC+ACpeak) or less

1 Value measured under standard operating conditions.

Combined with the 700929 or 701947

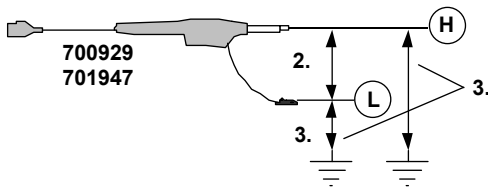

Direct input (cable not complying with the safety standard)

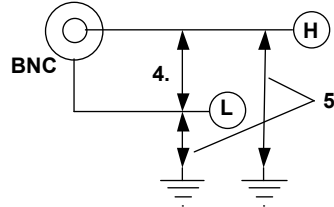

**Withstand voltage: 1500 Vrms for 1 minute**  
**Allowable transient surge voltage (between earth and input):  $\pm 2100$  Vpeak**

- 6 Input waveform of 1 Vpp, rectangular wave, rise/fall time within 1 ms (input range:  $\pm 10$  V, bandwidth limit: Full, and hysteresis:  $\pm 1\%$ )
- 7 Input waveform of 90 Vrms, sine wave (input range: AC100 V, bandwidth limit 100 kHz, and hysteresis:  $\pm 1\%$ )
- 8 Input waveform of 1 Vpp, rectangular wave, rise/fall time within 5 ns (input range:  $\pm 10$  V, bandwidth limit: Full, and hysteresis:  $\pm 1\%$ )
- 9 Typical value represents a typical or average value. It is not strictly warranted.



### WARNING

- Do not apply input voltage exceeding the maximum input voltage or allowable common mode input voltage.
- To prevent the possibility of electric shock, be sure to furnish protective earth grounding of the DL850/DL850V.
- To prevent the possibility of electric shock, be sure to fasten the module screws. Otherwise, the electrical and mechanical protection functions will not be activated.
- Avoid continuous connection under an environment in which the surge voltage may occur.

## Specifications by Measurement Modes

Item	Specifications
Frequency	
Measurable frequency range	0.01 Hz to 200 kHz
Selectable vertical axis sensitivity	0.1 Hz/div to 50 kHz/div (1-2-5 steps)
Minimum resolution	0.001 Hz
RPMs	
Measurable RPMs range	0.01 rpm to 100000 rpm (where the input frequency is DC to 200 kHz).
Selectable vertical axis sensitivity	0.1 rpm/div to 10 kpm/div (1-2-5 steps)
Computing method	Computed from the frequency based on the number of pulses per rotation RPMs = Frequency/(pulse/rotate value) × 60 1 to 99999
Selectable pulse/rotate range	
RPSs	
Measurable RPSs range	0.001 rps to 2000 rps (where the input frequency is DC to 200 kHz).
Selectable vertical axis sensitivity	0.01 rps/div to 200 rps/div (1-2-5 steps)
Computing method	Computed from the frequency based on the number of pulses per rotation RPSs = Frequency/(pulse/rotate value) 1 to 99999
Selectable pulse/rotate range	
Period	
Measurable period range	5 μs to 50 s (where the minimum pulse width is 2 μs)
Selectable vertical axis sensitivity	10 μs/div to 5 s/div (1-2-5 steps)
Minimum resolution	0.1 μs
Duty cycle	
Measurable duty cycle range	0 to 100%
Selectable vertical axis sensitivity	1 %/div to 20 %/div (1-2-5 steps)
Measurable frequency range	Select positive or negative pulse
Measurement pulse selection	0.01%
Minimum resolution	
Power supply frequency	
Measurable frequency range	30 Hz to 70 Hz (when the center frequency is 50 Hz), 40 Hz to 80 Hz (when the center frequency is 60 Hz), 380 Hz to 420 Hz (when the center frequency is 400 Hz)
Selectable vertical axis sensitivity	0.1 Hz/div to 2 Hz/div (0.01 Hz resolution)
Center frequency setting	Select 50 Hz, 60 Hz, or 400 Hz
Minimum resolution	0.01 Hz
Pulse width	
Measurable pulse width	2 μs to 50 s (where the input frequency is up to 200 kHz)
Selectable vertical axis sensitivity	10 μs/div to 5 s/div (1-2-5 steps)
Measurement pulse selection	Select positive or negative pulse
Minimum resolution	0.1 μs
Pulse integration	
Maximum pulse count	2×10 <sup>9</sup> pulses
Selectable vertical axis sensitivity	500.0E+18 value/div to 10.00E-21 value/div (1-2-5 range: total of 123 ranges)
Frequency measuring range	0.1 Hz to 200 kHz (where the minimum pulse width is 2 μs)
Computation function	Set the physical amount per pulse and display by converting the values into physical values such as distance and flow rate. -9.9999E+30 to +9.9999E+30
Selectable Unit/Pulse range	Manual reset and over-limit reset
Counter reset	
Velocity	
Selectable vertical axis sensitivity	500.0 E+18 value/div to 10.00 E-21 value/div (1-2-5 range: total of 123 ranges)
Computing method	Set the amount of displacement per pulse and compute the velocity from the frequency Automatic unit time conversion of s, min, and hour.
Selectable Distance/Pulse range	-9.9999E+30 to +9.9999E+30

## 6.13 Module Specifications

---

### Functional Specifications

Item	Specifications
Deceleration prediction	Computes the deceleration condition in realtime when the pulse input is cut off. Can be specified when measuring the frequency, RPMs, RPSs, period, and velocity
Stop prediction	Sets the frequency to 0 after a certain time elapses after the pulse input is cut off. Stop interval setting: Set in the range of 1.5 to 10 times (10 settings) the period of the pulse measured last Can be specified when measuring the frequency, RPMs, RPSs, period, and velocity
Smoothing	Computes the moving average of the measured data using the specified time Specified time: 0.1 to 1000 ms (0.1 ms resolution) Can be specified on all measurement parameters
Pulse average	Performs frequency measurement per specified number of pulses. When fluctuation exists periodically in the pulse interval, the fluctuation can be eliminated. Specified number of pulses: 1 to 4096 Can be specified when measuring the frequency, RPMs, RPSs, power supply frequency, period, pulse integration, and velocity
Offset function	Observe fluctuation with respect to the offset frequency Offset range: Can be set up to 1000 times the maximum div value <ul style="list-style-type: none"><li>• Frequency: 0 Hz to 200 kHz</li><li>• RPMs: 0 rpm to 50 krpm</li><li>• RPSs: 0 rps to 1000 rps</li><li>• Period: 0 s to 50 s</li><li>• Duty cycle: 0% to 100%</li><li>• Pulse width: 0 s to 50 s</li><li>• Pulse integration: <math>-1.0000 \times 10^{22}</math> to <math>1.0000 \times 10^{22}</math></li><li>• Velocity: <math>-1.0000 \times 10^{22}</math> to <math>1.0000 \times 10^{22}</math></li></ul>

## High-Speed 100 MS/s, 12-Bit Isolation Module (720210) Specifications

Item	Specifications
Standard operating conditions	Temperature: 23°C±5°C Humidity: 20% to 80%RH After a 30-minute warm-up and after calibration
Effective measurement range	20 div (display range: 10 div)
Number of input channels	2
Input coupling	AC, DC, and GND
Maximum sample rate	100 MS/s
Input format	Isolated unbalanced
Frequency characteristics <sup>1</sup>	(-3 dB point when sine wave of amplitude ±3 div is applied) DC to 20 MHz
Voltage-axis sensitivity setting	10 mV/div to 20 V/div (1-2-5 steps) (when using 1:1 probe attenuation)
Maximum input voltage (at a frequency of 1 kHz or less)	Combined with the 700929(10:1) or 701947(100:1): <sup>2</sup> 1000 V (DC+ACpeak) CATII Direct input or cable not complying with the safety standard: <sup>4</sup> 200 V (DC+ACpeak)
Maximum allowable common mode voltage (at a frequency of 1 kHz or less)	Working voltage of safety standard Combined with the 700929 (10:1) or 701947 (100:1): <sup>3</sup> 1000 Vrms (CAT II) Direct input or cable not complying with the safety standard: <sup>5</sup> 42 V (DC+ACpeak) (CAT I and CAT II, 30 Vrms)
Vertical (voltage) axis accuracy DC accuracy <sup>1</sup>	10 mV/div to 20 V/div: ±(0.5% of 10 div)
Input connector	BNC connector (isolated type)
Input impedance	1 MΩ ± 1%, approx. 35 pF
-3 dB point when AC coupled low frequency attenuation point	10 Hz or less (1 Hz or less when using the 700929, 0.1 Hz or less when using the 700929)
Common mode rejection ratio	80 dB (50/60 Hz) or more (typical <sup>6</sup> )
Residual noise level (Input section shorted)	±1.1 mV or ±0.15 /div whichever is greater (Typical <sup>6</sup> )
Withstand voltage	1500 Vrms for 1 minute (across each terminal and earth) (60 Hz)
Insulation resistance	500 VDC, 10 MΩ or more (across each input terminal and earth)
A/D conversion resolution	12 bit (150 LSB/div)
Temperature coefficient	Zero point: 10 mV/div to 20 V/div: ±(0.1% of 10 div)/°C(Typical <sup>6</sup> ) Gain: ±(0.05% of 10 div)/°C(Typical <sup>6</sup> )
Bandwidth limit	Select from OFF, 2 MHz, 1.28 MHz, 640 kHz, 320 kHz, 160 kHz, 80 kHz, 40 kHz, 20 kHz, and 10 kHz Cut-off characteristics: -12 dB/OCT (when 2 MHz, Typical <sup>6</sup> )
Probe attenuation setting	Voltage probe: 1:1, 10:1, 100:1, 1000:1 Current probe: 10 A:1 V (for the 700937/701933), 100 A: 1 V (for the 701930/701931)

1 Value measured under standard operating conditions.

Combined with the 700929 or 701947

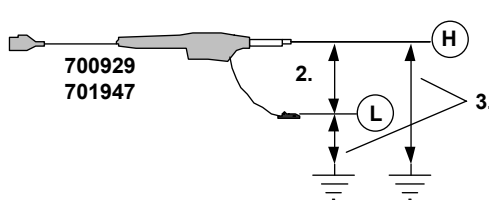

Direct input (cable not complying with the safety standard)

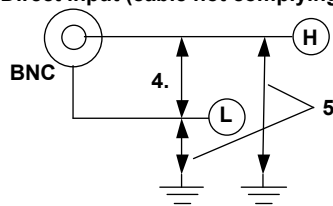

**Withstand voltage: 1500 Vrms for 1 minute**

**Allowable transient surge voltage (between earth and input): ±2100 Vpeak**

6 Typical value represents a typical or average value. It is not strictly warranted.





---

### **WARNING**

- Do not apply input voltage exceeding the maximum input voltage or allowable common mode input voltage.
  - To prevent the possibility of electric shock, be sure to furnish protective earth grounding of the DL850/DL850V.
  - To prevent the possibility of electric shock, be sure to fasten the module screws. Otherwise, the electrical and mechanical protection functions will not be activated.
  - Avoid continuous connection under an environment in which the surge voltage may occur.
-

## 16-CH Voltage Input Module (720220) Specifications

Item	Specifications
Standard operating conditions	Ambient temperature: $23 \pm 5^\circ\text{C}$ Ambient humidity: 20 to 80% RH After the DL850/DL850V has been warmed up for 30 minutes and then calibration has been performed
Valid measurement range	20 div (0 V $\pm$ 10 div. Display range: 10 div. When Variable is set to OFF)
Number of input channels	16
Input coupling settings	DC, GND, and OFF
Maximum sample rate	200 kS/s for a single channel, 16 ch $\times$ 10 kS/s
Input format	All isolated unbalanced
Frequency characteristics <sup>1</sup> (-3 dB point when a sine wave with an amplitude of $\pm 3$ div is applied)	DC to 5 kHz
Selectable voltage sensitivity range	0.2 V/div to 2 V/div (in 1-2-5 steps)
Max. measurement voltage range	$\pm 20$ V
Maximum input voltage (at a frequency of 1 kHz or less)	Direct input 42 V (DC + ACpeak)
Maximum allowable common mode voltage (at a frequency of 1 kHz or less)	The Working Voltage in the safety standards Direct input 42 V (DC + ACpeak) (CAT I and CAT II, 30 Vrms)
DC vertical-axis (voltage-axis) accuracy	$\pm$ (0.3% of 10 div)
Input connector	Spring terminal blocks. Each 8-channel unit is removable.
Input impedance	1 M $\Omega$ $\pm$ 1%
Common mode rejection ratio	80 dB (50/60 Hz) or more (typical value)
Residual noise level (input section shorted)	$\pm 0.05$ div
A/D converter resolution	16 bits, 2400 LSB/div
Temperature coefficient	Zero point: $\pm(0.02\%$ of 10 div) $^\circ\text{C}$ (typical value) Gain: $\pm(0.02\%$ of 10 div) $^\circ\text{C}$ (typical value)
Bandwidth limit	Can be turned off or set to 500 Hz on each sub channel
Wiring	Recommended: 0.20 mm <sup>2</sup> to 1.00 mm <sup>2</sup> . AWG size: 24-18.



### WARNING

- When connecting a device under measurement to the instrument, be sure to turn off the device. It is extremely dangerous to connect or remove wires while the device under measurement is on.

#### Avoid Electric Shock When Using the Modules

- Do not apply a voltage that exceeds the maximum input voltage, withstand voltage, or allowable surge voltage.
- To avoid electric shock, be sure to ground the instrument.
- To prevent the possibility of electric shock, be sure to fasten the module screws. Otherwise, the electrical and mechanical protection functions will not be activated.
- Do not leave the instrument connected to devices in an environment that may be subject to voltage surges.
- To prevent electric shock, connect wires to the terminal block that match the voltage range that you are measuring.
- Applying a voltage greater than the limits listed below may damage the input section. For frequencies above 1 kHz, damage may occur even if the voltage is less than the limits listed below.

Maximum input voltage between H and L input terminals when the frequency is 1 kHz or less<sup>1</sup>

42 V (DC + ACpeak)

Maximum allowable common mode voltage between the H or L input terminal and the ground when the frequency is 1 kHz or less<sup>2</sup>

42V (DC + ACpeak, CAT I and CAT II, 30 Vrms)

## 6.13 Module Specifications

- Wire all the L input terminals for all the sub channels on the same module to the same potential. The L input terminals of the sub channels are all connected. Because the L input terminals are electrically connected inside the DL850/DL850V, connecting different potentials to them could result in short circuiting and damage to the 16-CH Voltage Input Module.

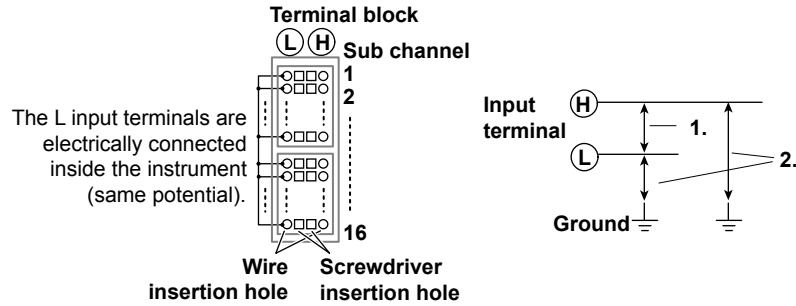

- When you release or lock the terminal block release levers, be careful not to injure yourself on the levers' protrusions.

### CAUTION

When you attach the terminal block, if you try to attach it upside down, you may damage the terminal block and the module. Check the vertical orientation of the block before you install it.

## Logic Input Module (720230) Specifications

Item	Specifications
Standard operating conditions	Ambient temperature: 23 ± 5°C
	Ambient humidity: 20 to 80% RH
Number of input ports	2
Number of input bits	8 bits per port
Maximum sample rate	10 MS/s
Input format	Use a non-isolated, dedicated probe (automatic detection)
Compatible probes	700986 (non-isolated 8-bit input)
	700987 (isolated 8-bit input)
	702911 (non-isolated 8-bit input)
	702912 (non-isolated 8-bit input)
Chatter suppression time settings	Off, 5 ms, 10 ms, 20 ms, 50 ms, and 100 ms



### CAUTION

- Applying a voltage greater than the limits listed below may damage the logic probe or the instrument. For frequencies above 1 kHz, damage may occur even if the voltage is less than the limits listed below.  
Maximum input voltage (at a frequency of 1 kHz or less)
  - Logic probes 702911 and 702912: 35 V
  - High-speed logic probe 700986: 42 V (DC + ACpeak)
  - Isolated logic probe 700987: 250 Vrms (however, ACpeak must be less than 350 V, and DC must be less than 250 V)
- For logic probes 702911, 702912, 700986, and the high-speed logic probe, the eight input lines of a single pod share the same ground. Also, the instrument's ground and the grounds of each pod are connected. Do not apply signals with different common voltages to each input line. Doing so may damage the instrument, connected logic probes, and connected devices.
- The input terminals of an isolated logic probe are isolated from each other and from the DL850/DL850V.
- Turn off the DL850/DL850V before you connect or remove a 26-pin connector from the logic signal input connector.
- Do not stack isolated logic probes. Also, to prevent a probe's internal temperature from rising, provide a sufficient amount of space around it.
- Do not use the YOKOGAWA 700985 logic probe with the DL850/DL850V. The 700985 is shaped so that it can be connected to the logic signal input connector of the DL850/DL850V, but it is not electrically compatible with the DL850/DL850V, so connecting the two could damage the DL850/DL850V or the 700985.

## 6.13 Module Specifications

### CAN Bus Monitor Module (720240) Specification

Item	Specifications
Standard operating condition	Ambient temperature: 23±5°C Ambient humidity: 20 to 80%RH
Number of input ports	2
Maximum sample rate	100 kS/s
Input format	Isolated unbalanced
Maximum input voltage	-3 to +10 V (between CAN_H and GND or CAN_L and GND)
Maximum allowable common mode voltage	30 Vrms (CAT I and II)
Input connector	D-sub 9 pin (male)
Terminator	Internal, can be enabled or disabled for each port
Supported protocol	Physical layer: ISO-11898 (High Speed Communication)
Supported bit rates <sup>1</sup>	10 kbps, 20 kbps, 33.3 kbps, 50 kbps, 62.5 kbps, 66.7 kbps, 83.3 kbps, 125 kbps, 250 kbps, 500 kbps, 800 kbps, 1 Mbps
LED display	Illuminates to indicate that the terminator is enabled
Number of sub channels	16 sub channels/ports (60 for firmware versions 1.2 and later)
One shot output	Frames can be output in single shots
Terminator resistance (when the terminator is enabled)	110 to 130 Ω
A/D converter resolution (when Value Type is set to Float <sup>2</sup> )	16 bits, 2400 LSB/div

- 1 Low-speed CAN at low-speed transceiver levels is not supported.
- 2 Applies to modules whose firmware version is 1.2 or later

## 6.14 Logic Probe Specifications

### High-Speed Logic Probe (700986) Specifications

Item	Specifications
Number of inputs	8
Input format	Non-isolated (all the bits share the same ground with the DL850/DL850V and each other)
Maximum input voltage	42V (DC + ACpeak, CAT I and CAT II, 30 Vrms), between the probe tip and ground (at a frequency of 1 kHz or less)
Response time	Within 1 $\mu$ s
Input impedance	100 k $\Omega$ or more
Threshold level	Approx. 1.4 V

### Isolated Logic Probe (700987) Specifications

Item	Specifications										
Number of inputs	8										
Input format	Isolated (all bits are isolated)										
Input connector	Safety terminal type (for banana plug) $\times$ 8										
Input switching	Each bit can be switched to AC or DC input.										
Input signal display	The H/L state of each bit is indicated with LEDs (the LEDs illuminate to indicate H).										
Applicable input range	During DC input: H/L detection of 10 VDC to 250 VDC During AC input: H/L detection of 80 VAC to 250 VAC at 50/60 Hz										
Threshold level	During DC input: 6 V $\pm$ 50% (High level: 10 to 250 VDC, Low level: 0 to 3 VDC) During AC input: 50 VAC $\pm$ 50% (High level: 80 to 250 VAC, Low level: 0 to 20 VAC)										
Response time	During DC input: 1 ms or less During AC input: 20 ms or less										
Input impedance	Approx. 100 k $\Omega$										
Maximum input voltage (between the H and L terminals of each bit)	250 Vrms <sup>1</sup> (CAT I and CAT II)										
Maximum allowable common mode voltage (between input terminal H or L and the ground)	250 Vrms <sup>1</sup> (CAT I and CAT II)										
Maximum allowable voltage between bits	250 Vrms <sup>1</sup> (CAT I and CAT II)										
Withstand voltage (between the input terminals and the ground)	2000 VAC for 1 minute										
Insulation resistance (between the input terminals and the ground)	500 VDC, 10 M $\Omega$ or greater										
Fuse <sup>2</sup>	<table border="1"> <thead> <tr> <th>Location</th> <th>Max. rated voltage</th> <th>Max. rated current</th> <th>Type</th> <th>Standard</th> </tr> </thead> <tbody> <tr> <td>H side of input terminal</td> <td>250 V</td> <td>50 mA</td> <td>Time lag</td> <td>VDE/SEMKO approved</td> </tr> </tbody> </table>	Location	Max. rated voltage	Max. rated current	Type	Standard	H side of input terminal	250 V	50 mA	Time lag	VDE/SEMKO approved
Location	Max. rated voltage	Max. rated current	Type	Standard							
H side of input terminal	250 V	50 mA	Time lag	VDE/SEMKO approved							

- 1 Make sure that the peak AC voltage does not exceed 350 V and that the DC voltage does not exceed 250 V when the frequency is 1 kHz or less.
- 2 Because the fuses used by this instrument are all inside the case, you cannot replace them yourself. If you believe that the fuse inside the case has blown, please contact your nearest YOKOGAWA dealer.

### Logic Probe (702911 and 702912) Specifications

Item	Specifications
Number of inputs	8
Input format	Non-isolated (all the bits share the same ground with the DL850/DL850V and each other)
Maximum input voltage	$\pm$ 35 V
Response time	Within 3 $\mu$ s
Input impedance	10 k $\Omega$ or more
Threshold level	Approx. 1.4 V
Input methods	TTL level or contact input (switchable). During contact input: Pulled up to 5 V

# 6.15 External Dimensions

## DL850/DL850V

Unit: mm

Unless otherwise specified, tolerances are  $\pm 3\%$  (however, tolerances are  $\pm 0.3$  mm when below 10 mm).

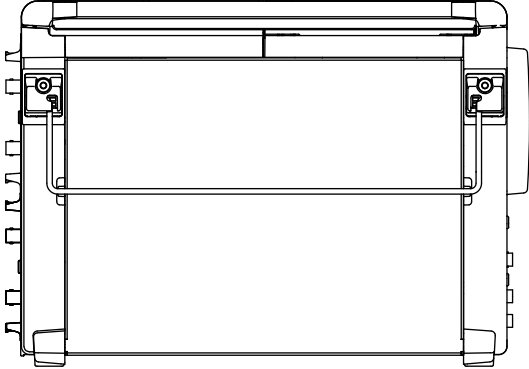
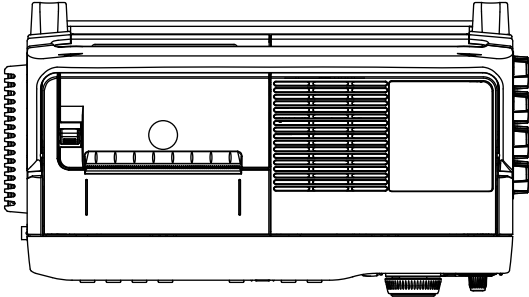

Rear view

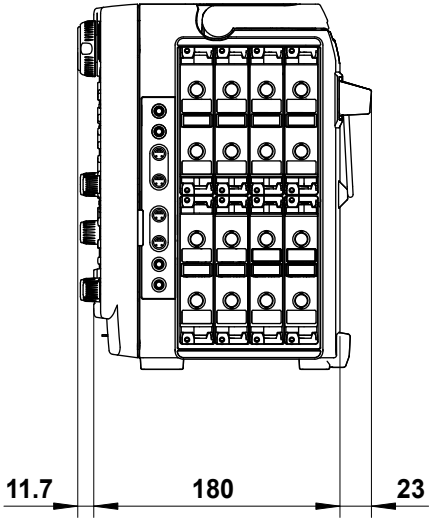
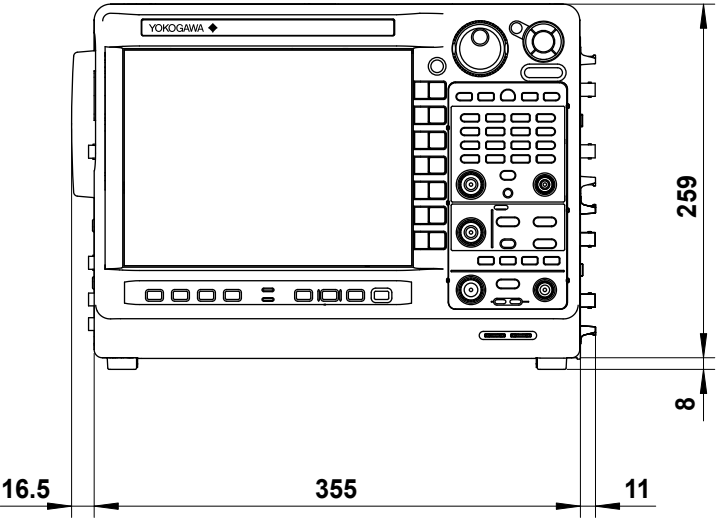

# Appendix 1 Relationship between the Time Axis Setting, Record Length, and Sample Rate

**When the High-Speed 100 MS/s, 12-Bit Isolation Module Is Installed**

**When the Record Length Is 1 kpoint, 2.5 kpoint, 5 kpoint, 10 kpoint, or 25 kpoint**

Time/div	Record									
	1 kpoint		2.5 kpoint		5 kpoint		10 kpoint		25 kpoint	
	Sample Rate (S/s)	Display Record Length (Points)	Sample Rate (S/s)	Display Record Length (Points)	Sample Rate (S/s)	Display Record Length (Points)	Sample Rate (S/s)	Display Record Length (Points)	Sample Rate (S/s)	Display Record Length (Points)
100 ns	100 M	100	100 M	100	100 M	100	100 M	100	100 M	100
200 ns	100 M	200	100 M	200	100 M	200	100 M	200	100 M	200
500 ns	100 M	500	100 M	500	100 M	500	100 M	500	100 M	500
1 μs	100 M	1 k	100 M	1 k	100 M	1 k	100 M	1 k	100 M	1 k
2 μs	50 M	1 k	100 M	2 k	100 M	2 k	100 M	2 k	100 M	2 k
5 μs	20 M	1 k	50 M	2.5 k	100 M	5 k	100 M	5 k	100 M	5 k
10 μs	10 M	1 k	20 M	2 k	50 M	5 k	100 M	10 k	100 M	10 k
20 μs	5 M	1 k	10 M	2 k	20 M	4 k	50 M	10 k	100 M	20 k
50 μs	2 M	1 k	5 M	2.5 k	10 M	5 k	20 M	10 k	50 M	25 k
100 μs	1 M	1 k	2 M	2 k	5 M	5 k	10 M	10 k	20 M	20 k
200 μs	500 k	1 k	1 M	2 k	2 M	4 k	5 M	10 k	10 M	20 k
500 μs	200 k	1 k	500 k	2.5 k	1 M	5 k	2 M	10 k	5 M	25 k
1 ms	100 k	1 k	200 k	2 k	500 k	5 k	1 M	10 k	2 M	20 k
2 ms	50 k	1 k	100 k	2 k	200 k	4 k	500 k	10 k	1 M	20 k
5 ms	20 k	1 k	50 k	2.5 k	100 k	5 k	200 k	10 k	500 k	25 k
10 ms	10 k	1 k	20 k	2 k	50 k	5 k	100 k	10 k	200 k	20 k
20 ms	5 k	1 k	10 k	2 k	20 k	4 k	50 k	10 k	100 k	20 k
50 ms	2 k	1 k	5 k	2.5 k	10 k	5 k	20 k	10 k	50 k	25 k
100 ms	1 k	1 k	2 k	2 k	5 k	5 k	10 k	10 k	20 k	20 k
200 ms	500	1 k	1 k	2 k	2 k	4 k	5 k	10 k	10 k	20 k
500 ms	200	1 k	500	2.5 k	1 k	5 k	2 k	10 k	5 k	25 k
1 s	100	1 k	200	2 k	500	5 k	1 k	10 k	2 k	20 k
2 s	50	1 k	100	2 k	200	4 k	500	10 k	1 k	20 k
3 s	20	600	50	1.5 k	100	3 k	200	6 k	500	15 k
4 s	20	800	50	2 k	100	4 k	200	8 k	500	20 k
5 s	20	1 k	50	2.5 k	100	5 k	200	10 k	500	25 k
6 s	10	600	20	1.2 k	50	3 k	100	6 k	200	12 k
8 s	10	800	20	1.6 k	50	4 k	100	8 k	200	16 k
10 s	10	1 k	20	2 k	50	5 k	100	10 k	200	20 k
20 s	5	1 k	10	2 k	20	4 k	50	10 k	100	20 k
30 s			5	1.5 k	10	3 k	20	6 k	50	15 k
1 min					5	3 k	10	6 k	20	12 k
2 min							5	6 k	20	24 k
3 min							5	9 k	10	18 k
4 min									10	24 k
5 min									5	15 k
6 min									5	18 k
7 min									5	21 k

When the time axis setting is 100 ms or greater (the settings surrounded by bold lines) and the trigger mode is Auto or Auto Level, waveforms are displayed in roll mode.



Appendix 1 Relationship between the Time Axis Setting, Record Length, and Sample Rate

When the Record Length Is 50 kpoint, 100 kpoint, 250 kpoint, 500 kpoint, or 1 Mpoint

Time/div	Record Length									
	50 kpoint		100 kpoint		250 kpoint		500 kpoint		1 Mpoint	
	Sample Rate (S/s)	Display Record Length (Points)	Sample Rate (S/s)	Display Record Length (Points)	Sample Rate (S/s)	Display Record Length (Points)	Sample Rate (S/s)	Display Record Length (Points)	Sample Rate (S/s)	Display Record Length (Points)
100 ns	100 M	100	100 M	100	100 M	100	100 M	100	100 M	100
200 ns	100 M	200	100 M	200	100 M	200	100 M	200	100 M	200
500 ns	100 M	500	100 M	500	100 M	500	100 M	500	100 M	500
1 µs	100 M	1 k	100 M	1 k	100 M	1 k	100 M	1 k	100 M	1 k
2 µs	100 M	2 k	100 M	2 k	100 M	2 k	100 M	2 k	100 M	2 k
5 µs	100 M	5 k	100 M	5 k	100 M	5 k	100 M	5 k	100 M	5 k
10 µs	100 M	10 k	100 M	10 k	100 M	10 k	100 M	10 k	100 M	10 k
20 µs	100 M	20 k	100 M	20 k	100 M	20 k	100 M	20 k	100 M	20 k
50 µs	100 M	50 k	100 M	50 k	100 M	50 k	100 M	50 k	100 M	50 k
100 µs	50 M	50 k	100 M	100 k	100 M	100 k	100 M	100 k	100 M	100 k
200 µs	20 M	40 k	50 M	100 k	100 M	200 k	100 M	200 k	100 M	200 k
500 µs	10 M	50 k	20 M	100 k	50 M	250 k	100 M	500 k	100 M	500 k
1 ms	5 M	50 k	10 M	100 k	20 M	200 k	50 M	500 k	100 M	1 M
2 ms	2 M	40 k	5 M	100 k	10 M	200 k	20 M	400 k	50 M	1 M
5 ms	1 M	50 k	2 M	100 k	5 M	250 k	10 M	500 k	20 M	1 M
10 ms	500 k	50 k	1 M	100 k	2 M	200 k	5 M	500 k	10 M	1 M
20 ms	200 k	40 k	500 k	100 k	1 M	200 k	2 M	400 k	5 M	1 M
50 ms	100 k	50 k	200 k	100 k	500 k	250 k	1 M	500 k	2 M	1 M
100 ms	50 k	50 k	100 k	100 k	200 k	200 k	500 k	500 k	1 M	1 M
200 ms	20 k	40 k	50 k	100 k	100 k	200 k	200 k	400 k	500 k	1 M
500 ms	10 k	50 k	20 k	100 k	50 k	250 k	100 k	500 k	200 k	1 M
1 s	5 k	50 k	10 k	100 k	20 k	200 k	50 k	500 k	100 k	1 M
2 s	2 k	40 k	5 k	100 k	10 k	200 k	20 k	400 k	50 k	1 M
3 s	1 k	30 k	2 k	60 k	5 k	150 k	10 k	300 k	20 k	600 k
4 s	1 k	40 k	2 k	80 k	5 k	200 k	10 k	400 k	20 k	800 k
5 s	1 k	50 k	2 k	100 k	5 k	250 k	10 k	500 k	20 k	1 M
6 s	500	30 k	1 k	60 k	2 k	120 k	5 k	300 k	10 k	600 k
8 s	500	40 k	1 k	80 k	2 k	160 k	5 k	400 k	10 k	800 k
10 s	500	50 k	1 k	100 k	2 k	200 k	5 k	500 k	10 k	1 M
20 s	200	40 k	500	100 k	1 k	200 k	2 k	400 k	5 k	1 M
30 s	100	30 k	200	60 k	500	150 k	1 k	300 k	2 k	600 k
1 min	50	30 k	100	60 k	200	120 k	500	300 k	1 k	600 k
2 min	20	24 k	50	60 k	200	240 k	200	240 k	500	600 k
3 min	20	36 k	50	90 k	100	180 k	200	360 k	500	900 k
4 min	20	48 k	20	48 k	100	240 k	200	480 k	200	480 k
5 min	10	30 k	20	60 k	50	150 k	100	300 k	200	600 k
6 min	10	36 k	20	72 k	50	180 k	100	360 k	200	720 k
7 min	10	42 k	20	84 k	50	210 k	100	420 k	200	840 k
8 min	10	48 k	20	96 k	50	240 k	100	480 k	200	960 k
9 min	5	27 k	10	54 k	20	108 k	50	270 k	100	540 k
10 min	5	30 k	10	60 k	20	120 k	50	300 k	100	600 k
12 min	5	36 k	10	72 k	20	144 k	50	360 k	100	720 k
15 min	5	45 k	10	90 k	20	180 k	50	450 k	100	900 k
30 min			5	90 k	10	180 k	20	360 k	50	900 k
1 h					5	180 k	10	360 k	20	720 k
2 h							5	360 k	10	720 k
3 h								5	540 k	
4 h								5	720 k	
5 h								5	900 k	

When the time axis setting is 100 ms or greater (the settings surrounded by bold lines) and the trigger mode is Auto or Auto Level, waveforms are displayed in roll mode.

When the Record Length Is 2.5 Mpoint, 5 Mpoint, 10 Mpoint, 25 Mpoint, or 50 Mpoint

Time/div	Record Length									
	2.5 Mpoint		5 Mpoint		10 Mpoint		25 Mpoint		50 Mpoint	
	Sample Rate (S/s)	Display Record Length (Points)	Sample Rate (S/s)	Display Record Length (Points)	Sample Rate (S/s)	Display Record Length (Points)	Sample Rate (S/s)	Display Record Length (Points)	Sample Rate (S/s)	Display Record Length (Points)
100 ns	100 M	100	100 M	100	100 M	100	100 M	100	100 M	100
200 ns	100 M	200	100 M	200	100 M	200	100 M	200	100 M	200
500 ns	100 M	500	100 M	500	100 M	500	100 M	500	100 M	500
1 μs	100 M	1 k	100 M	1 k	100 M	1 k	100 M	1 k	100 M	1 k
2 μs	100 M	2 k	100 M	2 k	100 M	2 k	100 M	2 k	100 M	2 k
5 μs	100 M	5 k	100 M	5 k	100 M	5 k	100 M	5 k	100 M	5 k
10 μs	100 M	10 k	100 M	10 k	100 M	10 k	100 M	10 k	100 M	10 k
20 μs	100 M	20 k	100 M	20 k	100 M	20 k	100 M	20 k	100 M	20 k
50 μs	100 M	50 k	100 M	50 k	100 M	50 k	100 M	50 k	100 M	50 k
100 μs	100 M	100 k	100 M	100 k	100 M	100 k	100 M	100 k	100 M	100 k
200 μs	100 M	200 k	100 M	200 k	100 M	200 k	100 M	200 k	100 M	200 k
500 μs	100 M	500 k	100 M	500 k	100 M	500 k	100 M	500 k	100 M	500 k
1 ms	100 M	1 M	100 M	1 M	100 M	1 M	100 M	1 M	100 M	1 M
2 ms	100 M	2 M	100 M	2 M	100 M	2 M	100 M	2 M	100 M	2 M
5 ms	50 M	2.5 M	100 M	5 M	100 M	5 M	100 M	5 M	100 M	5 M
10 ms	20 M	2 M	50 M	5 M	100 M	10 M	100 M	10 M	100 M	10 M
20 ms	10 M	2 M	20 M	4 M	50 M	10 M	100 M	20 M	100 M	20 M
50 ms	5 M	2.5 M	10 M	5 M	20 M	10 M	50 M	25 M	100 M	50 M
100 ms	2 M	2 M	5 M	5 M	10 M	10 M	20 M	20 M	50 M	50 M
200 ms	1 M	2 M	2 M	4 M	5 M	10 M	10 M	20 M	20 M	40 M
500 ms	500 k	2.5 M	1 M	5 M	2 M	10 M	5 M	25 M	10 M	50 M
1 s	200 k	2 M	500 k	5 M	1 M	10 M	2 M	20 M	5 M	50 M
2 s	100 k	2 M	200 k	4 M	500 k	10 M	1 M	20 M	2 M	40 M
3 s	50 k	1.5 M	100 k	3 M	200 k	6 M	500 k	15 M	1 M	30 M
4 s	50 k	2 M	100 k	4 M	200 k	8 M	500 k	20 M	1 M	40 M
5 s	50 k	2.5 M	100 k	5 M	200 k	10 M	500 k	25 M	1 M	50 M
6 s	20 k	1.2 M	50 k	3 M	100 k	6 M	200 k	12 M	500 k	30 M
8 s	20 k	1.6 M	50 k	4 M	100 k	8 M	200 k	16 M	500 k	40 M
10 s	20 k	2 M	50 k	5 M	100 k	10 M	200 k	20 M	500 k	50 M
20 s	10 k	2 M	20 k	4 M	50 k	10 M	100 k	20 M	200 k	40 M
30 s	5 k	1.5 M	10 k	3 M	20 k	6 M	50 k	15 M	100 k	30 M
1 min	2 k	1.2 M	5 k	3 M	10 k	6 M	20 k	12 M	50 k	30 M
2 min	2 k	2.4 M	2 k	2.4 M	5 k	6 M	20 k	24 M	20 k	24 M
3 min	1 k	1.8 M	2 k	3.6 M	5 k	9 M	10 k	18 M	20 k	36 M
4 min	1 k	2.4 M	2 k	4.8 M	2 k	4.8 M	10 k	24 M	20 k	48 M
5 min	500	1.5 M	1 k	3 M	2 k	6 M	5 k	15 M	10 k	30 M
6 min	500	1.8 M	1 k	3.6 M	2 k	7.2 M	5 k	18 M	10 k	36 M
7 min	500	2.1 M	1 k	4.2 M	2 k	8.4 M	5 k	21 M	10 k	42 M
8 min	500	2.4 M	1 k	4.8 M	2 k	9.6 M	5 k	24 M	10 k	48 M
9 min	200	1.08 M	500	2.7 M	1 k	5.4 M	2 k	10.8 M	5 k	27 M
10 min	200	1.2 M	500	3 M	1 k	6 M	2 k	12 M	5 k	30 M
12 min	200	1.44 M	500	3.6 M	1 k	7.2 M	2 k	14.4 M	5 k	36 M
15 min	200	1.8 M	500	4.5 M	1 k	9 M	2 k	18 M	5 k	45 M
30 min	100	1.8 M	200	3.6 M	500	9 M	1 k	18 M	2 k	36 M
1 h	50	1.8 M	100	3.6 M	200	7.2 M	500	18 M	1 k	36 M
2 h	20	1.44 M	50	3.6 M	100	7.2 M	200	14.4 M	500	36 M
3 h	20	2.16 M	20	2.16 M	50	5.4 M	200	21.6 M	200	21.6 M
4 h	10	1.44 M	20	2.88 M	50	7.2 M	100	14.4 M	200	28.8 M
5 h	10	1.8 M	20	3.6 M	50	9 M	100	18 M	200	36 M

When the time axis setting is 100 ms or greater (the settings surrounded by bold lines) and the trigger mode is Auto or Auto Level, waveforms are displayed in roll mode.

(Continued on next page)

## Appendix 1 Relationship between the Time Axis Setting, Record Length, and Sample Rate

(Continued from previous page)

Time/div	Record Length									
	2.5 Mpoint		5 Mpoint		10 Mpoint		25 Mpoint		50 Mpoint	
	Sample Rate (S/s)	Display Record Length (Points)	Sample Rate (S/s)	Display Record Length (Points)	Sample Rate (S/s)	Display Record Length (Points)	Sample Rate (S/s)	Display Record Length (Points)	Sample Rate (S/s)	Display Record Length (Points)
6 h	10	2.16 M	20	4.32 M	20	4.32 M	100	21.6 M	200	43.2 M
7 h	5	1.26 M	10	2.52 M	20	5.04 M	50	12.6 M	100	25.2 M
8 h	5	1.44 M	10	2.88 M	20	5.76 M	50	14.4 M	100	28.8 M
9 h	5	1.62 M	10	3.24 M	20	6.48 M	50	16.2 M	100	32.4 M
10 h	5	1.8 M	10	3.6 M	20	7.2 M	50	18 M	100	36 M
12 h	5	2.16 M	10	4.32 M	20	8.64 M	50	21.6 M	100	43.2 M
1 day			5	4.32 M	10	8.64 M	20	17.28 M	50	43.2 M
2 days					5	8.64 M	10	17.28 M	20	34.56 M
3 days							5	12.96 M	10	25.92 M

When the time axis setting is 100 ms or greater (the settings surrounded by bold lines) and the trigger mode is Auto or Auto Level, waveforms are displayed in roll mode.

### When the Record Length Is 100 Mpoint, 250 Mpoint, 500 Mpoint, 1 Gpoint, or 2 Gpoint

Time/div	Record Length									
	100 Mpoint		250 Mpoint		500 Mpoint		1 Gpoint		2 Gpoint	
	Sample Rate (S/s)	Display Record Length (Points)	Sample Rate (S/s)	Display Record Length (Points)	Sample Rate (S/s)	Display Record Length (Points)	Sample Rate (S/s)	Display Record Length (Points)	Sample Rate (S/s)	Display Record Length (Points)
100 ns	100 M	100	100 M	100	100 M	100	100 M	100	100 M	100
200 ns	100 M	200	100 M	200	100 M	200	100 M	200	100 M	200
500 ns	100 M	500	100 M	500	100 M	500	100 M	500	100 M	500
1 μs	100 M	1 k	100 M	1 k	100 M	1 k	100 M	1 k	100 M	1 k
2 μs	100 M	2 k	100 M	2 k	100 M	2 k	100 M	2 k	100 M	2 k
5 μs	100 M	5 k	100 M	5 k	100 M	5 k	100 M	5 k	100 M	5 k
10 μs	100 M	10 k	100 M	10 k	100 M	10 k	100 M	10 k	100 M	10 k
20 μs	100 M	20 k	100 M	20 k	100 M	20 k	100 M	20 k	100 M	20 k
50 μs	100 M	50 k	100 M	50 k	100 M	50 k	100 M	50 k	100 M	50 k
100 μs	100 M	100 k	100 M	100 k	100 M	100 k	100 M	100 k	100 M	100 k
200 μs	100 M	200 k	100 M	200 k	100 M	200 k	100 M	200 k	100 M	200 k
500 μs	100 M	500 k	100 M	500 k	100 M	500 k	100 M	500 k	100 M	500 k
1 ms	100 M	1 M	100 M	1 M	100 M	1 M	100 M	1 M	100 M	1 M
2 ms	100 M	2 M	100 M	2 M	100 M	2 M	100 M	2 M	100 M	2 M
5 ms	100 M	5 M	100 M	5 M	100 M	5 M	100 M	5 M	100 M	5 M
10 ms	100 M	10 M	100 M	10 M	100 M	10 M	100 M	10 M	100 M	10 M
20 ms	100 M	20 M	100 M	20 M	100 M	20 M	100 M	20 M	100 M	20 M
50 ms	100 M	50 M	100 M	50 M	100 M	50 M	100 M	50 M	100 M	50 M
100 ms	100 M	100 M	100 M	100 M	100 M	100 M	100 M	100 M	100 M	100 M
200 ms	50 M	100 M	100 M	200 M	100 M	200 M	100 M	200 M	100 M	200 M
500 ms	20 M	100 M	50 M	250 M	100 M	500 M	100 M	500 M	100 M	500 M
1 s	10 M	100 M	20 M	200 M	50 M	500 M	100 M	1 G	100 M	1 G
2 s	5 M	100 M	10 M	200 M	20 M	400 M	50 M	1 G	100 M	2 G
3 s	2 M	60 M	5 M	150 M	10 M	300 M	20 M	600 M	50 M	1.5 G
4 s	2 M	80 M	5 M	200 M	10 M	400 M	20 M	800 M	50 M	2 G
5 s	2 M	100 M	5 M	250 M	10 M	500 M	20 M	1 G	20 M	1 G
6 s	1 M	60 M	2 M	120 M	5 M	300 M	10 M	600 M	20 M	1.2 G
8 s	1 M	80 M	2 M	160 M	5 M	400 M	10 M	800 M	20 M	1.6 G
10 s	1 M	100 M	2 M	200 M	5 M	500 M	10 M	1 G	20 M	2 G
20 s	500 k	100 M	1 M	200 M	2 M	400 M	5 M	1 G	10 M	2 G
30 s	200 k	60 M	500 k	150 M	1 M	300 M	2 M	600 M	5 M	1.5 G

When the time axis setting is 100 ms or greater (the settings surrounded by bold lines) and the trigger mode is Auto or Auto Level, waveforms are displayed in roll mode.

(Continued on next page)

## Appendix 1 Relationship between the Time Axis Setting, Record Length, and Sample Rate

(Continued from previous page)

Time/div	Record Length									
	100 Mpoint		250 Mpoint		500 Mpoint		1 Gpoint		2 Gpoint	
	Sample Rate (S/s)	Display Record Length (Points)	Sample Rate (S/s)	Display Record Length (Points)	Sample Rate (S/s)	Display Record Length (Points)	Sample Rate (S/s)	Display Record Length (Points)	Sample Rate (S/s)	Display Record Length (Points)
1 min	100 k	60 M	200 k	120 M	500 k	300 M	1 M	600 M	2 M	1.2 G
2 min	50 k	60 M	200 k	240 M	200 k	240 M	500 k	600 M	1 M	1.2 G
3 min	50 k	90 M	100 k	180 M	200 k	360 M	500 k	900 M	1 M	1.8 G
4 min	20 k	48 M	100 k	240 M	200 k	480 M	200 k	480 M	500 k	1.2 G
5 min	20 k	60 M	50 k	150 M	100 k	300 M	200 k	600 M	500 k	1.5 G
6 min	20 k	72 M	50 k	180 M	100 k	360 M	200 k	720 M	500 k	1.8 G
7 min	20 k	84 M	50 k	210 M	100 k	420 M	200 k	840 M	200 k	840 M
8 min	20 k	96 M	50 k	240 M	100 k	480 M	200 k	960 M	200 k	960 M
9 min	10 k	54 M	20 k	108 M	50 k	270 M	100 k	540 M	200 k	1.08 G
10 min	10 k	60 M	20 k	120 M	50 k	300 M	100 k	600 M	200 k	1.2 G
12 min	10 k	72 M	20 k	144 M	50 k	360 M	100 k	720 M	200 k	1.44 G
15 min	10 k	90 M	20 k	180 M	50 k	450 M	100 k	900 M	200 k	1.8 G
30 min	5 k	90 M	10 k	180 M	20 k	360 M	50 k	900 M	100 k	1.8 G
1 h	2 k	72 M	5 k	180 M	10 k	360 M	20 k	720 M	50 k	1.8 G
2 h	1 k	72 M	2 k	144 M	5 k	360 M	10 k	720 M	20 k	1.44 G
3 h	500	54 M	2 k	216 M	2 k	216 M	5 k	540 M	10 k	1.08 G
4 h	500	72 M	1 k	144 M	2 k	288 M	5 k	720 M	10 k	1.44 G
5 h	500	90 M	1 k	180 M	2 k	360 M	5 k	900 M	10 k	1.8 G
6 h	200	43.2 M	1 k	216 M	2 k	432 M	2 k	432 M	5 k	1.08 G
7 h	200	50.4 M	500	126 M	1 k	252 M	2 k	504 M	5 k	1.26 G
8 h	200	57.6 M	500	144 M	1 k	288 M	2 k	576 M	5 k	1.44 G
9 h	200	64.8 M	500	162 M	1 k	324 M	2 k	648 M	5 k	1.62 G
10 h	200	72 M	500	180 M	1 k	360 M	2 k	720 M	5 k	1.8 G
12 h	200	86.4 M	500	216 M	1 k	432 M	2 k	864 M	2 k	864 M
1 day	100	86.4 M	200	172.8 M	500	432 M	1 k	864 M	2 k	1.728 G
2 days	50	86.4 M	100	172.8 M	200	345.6 M	500	864 M	1 k	1.728 G
3 days	20	51.84 M	50	129.6 M	100	259.2 M	200	518.4 M	500	1.296 G

When the time axis setting is 100 ms or greater (the settings surrounded by bold lines) and the trigger mode is Auto or Auto Level, waveforms are displayed in roll mode.

Appendix 1 Relationship between the Time Axis Setting, Record Length, and Sample Rate

When the Record Length Is 4 Gpoint, 5 Gpoint, 10 Gpoint, 20 Gpoint, or 50 Gpoint

Time/div	Record Length									
	4 Gpoint		5 Gpoint		10 Gpoint		20 Gpoint		50 Gpoint	
	Sample Rate (S/s)	Display Record Length (Points)	Sample Rate (S/s)	Display Record Length (Points)	Sample Rate (S/s)	Display Record Length (Points)	Sample Rate (S/s)	Display Record Length (Points)	Sample Rate (S/s)	Display Record Length (Points)
100 ns										
200 ns										
500 ns										
1 μs										
2 μs										
5 μs										
10 μs										
20 μs										
50 μs										
100 μs										
200 μs										
500 μs										
1 ms										
2 ms										
5 ms										
10 ms										
20 ms										
50 ms										
100 ms										
200 ms										
500 ms										
1 s										
2 s										
3 s										
4 s										
5 s										
6 s										
8 s										
10 s										
20 s										
30 s										
1 min										
2 min										
3 min										
4 min	1 M	2.4 G								
5 min	1 M	3 G	1 M	3 G						
6 min	1 M	3.6 G	1 M	3.6 G						
7 min	500 k	2.1 G	1 M	4.2 G						
8 min	500 k	2.4 G	1 M	4.8 G						
9 min	500 k	2.7 G	500 k	2.7 G	1 M	5.4 G				
10 min	500 k	3 G	500 k	3 G	1 M	6 G				
12 min	500 k	3.6 G	500 k	3.6 G	1 M	7.2 G				
15 min	200 k	1.8 G	500 k	4.5 G	1 M	9 G				
30 min	200 k	3.6 G	200 k	3.6 G	500 k	9 G	1 M	18 G		
1 h	100 k	3.6 G	100 k	3.6 G	200 k	7.2 G	500 k	18 G	1 M	36 G
2 h	50 k	3.6 G	50 k	3.6 G	100 k	7.2 G	200 k	14.4 G	500 k	36 G
3 h	20 k	2.16 G	20 k	2.16 G	50 k	5.4 G	100 k	10.8 G	200 k	21.6 G
4 h	20 k	2.88 G	20 k	2.88 G	50 k	7.2 G	100 k	14.4 G	200 k	28.8 G
5 h	20 k	3.6 G	20 k	3.6 G	50 k	9 G	100 k	18 G	200 k	36 G

When the time axis setting is 100 ms or greater (the settings surrounded by bold lines) and the trigger mode is Auto or Auto Level, waveforms are displayed in roll mode.

(Continued on next page)

## Appendix 1 Relationship between the Time Axis Setting, Record Length, and Sample Rate

(Continued from previous page)

Time/div	Record Length									
	4 Gpoint		5 Gpoint		10 Gpoint		20 Gpoint		50 Gpoint	
	Sample Rate (S/s)	Display Record Length (Points)	Sample Rate (S/s)	Display Record Length (Points)	Sample Rate (S/s)	Display Record Length (Points)	Sample Rate (S/s)	Display Record Length (Points)	Sample Rate (S/s)	Display Record Length (Points)
6 h	10 k	2.16 G	20 k	4.32 G	20 k	4.32 G	50 k	10.8 G	200 k	43.2 G
7 h	10 k	2.52 G	10 k	2.52 G	20 k	5.04 G	50 k	12.6 G	100 k	25.2 G
8 h	10 k	2.88 G	10 k	2.88 G	20 k	5.76 G	50 k	14.4 G	100 k	28.8 G
9 h	10 k	3.24 G	10 k	3.24 G	20 k	6.48 G	50 k	16.2 G	100 k	32.4 G
10 h	10 k	3.6 G	10 k	3.6 G	20 k	7.2 G	50 k	18 G	100 k	36 G
12 h	5 k	2.16 G	10 k	4.32 G	20 k	8.64 G	20 k	8.64 G	100 k	43.2 G
1 day	2 k	1.728 G	5 k	4.32 G	10 k	8.64 G	20 k	17.28 G	50 k	43.2 G
2 days	2 k	3.456 G	2 k	3.456 G	5 k	8.64 G	10 k	17.28 G	20 k	34.56 G
3 days	1 k	2.592 G	1 k	2.592 G	2 k	5.184 G	5 k	12.96 G	10 k	25.9 G

When the time axis setting is 100 ms or greater (the settings surrounded by bold lines) and the trigger mode is Auto or Auto Level, waveforms are displayed in roll mode.

## When the High-Speed 100 MS/s, 12-Bit Isolation Module Is Not Installed

When the Record Length Is 1 kpoint, 2.5 kpoint, 5 kpoint, 10 kpoint, or 25 kpoint

Time/div	Record Length									
	1 kpoint		2.5 kpoint		5 kpoint		10 kpoint		25 kpoint	
	Sample Rate (S/s)	Display Record Length (Points)	Sample Rate (S/s)	Display Record Length (Points)	Sample Rate (S/s)	Display Record Length (Points)	Sample Rate (S/s)	Display Record Length (Points)	Sample Rate (S/s)	Display Record Length (Points)
1 μs	10 M	100	10 M	100	10 M	100	10 M	100	10 M	100
2 μs	10 M	200	10 M	200	10 M	200	10 M	200	10 M	200
5 μs	10 M	500	10 M	500	10 M	500	10 M	500	10 M	500
10 μs	10 M	1 k	10 M	1 k	10 M	1 k	10 M	1 k	10 M	1 k
20 μs	5 M	1 k	10 M	2 k	10 M	2 k	10 M	2 k	10 M	2 k
50 μs	2 M	1 k	5 M	2.5 k	10 M	5 k	10 M	5 k	10 M	5 k
100 μs	1 M	1 k	2 M	2 k	5 M	5 k	10 M	10 k	10 M	10 k
200 μs	500 k	1 k	1 M	2 k	2 M	4 k	5 M	10 k	10 M	20 k
500 μs	200 k	1 k	500 k	2.5 k	1 M	5 k	2 M	10 k	5 M	25 k
1 ms	100 k	1 k	200 k	2 k	500 k	5 k	1 M	10 k	2 M	20 k
2 ms	50 k	1 k	100 k	2 k	200 k	4 k	500 k	10 k	1 M	20 k
5 ms	20 k	1 k	50 k	2.5 k	100 k	5 k	200 k	10 k	500 k	25 k
10 ms	10 k	1 k	20 k	2 k	50 k	5 k	100 k	10 k	200 k	20 k
20 ms	5 k	1 k	10 k	2 k	20 k	4 k	50 k	10 k	100 k	20 k
50 ms	2 k	1 k	5 k	2.5 k	10 k	5 k	20 k	10 k	50 k	25 k
100 ms	1 k	1 k	2 k	2 k	5 k	5 k	10 k	10 k	20 k	20 k
200 ms	500	1 k	1 k	2 k	2 k	4 k	5 k	10 k	10 k	20 k
500 ms	200	1 k	500	2.5 k	1 k	5 k	2 k	10 k	5 k	25 k
1 s	100	1 k	200	2 k	500	5 k	1 k	10 k	2 k	20 k
2 s	50	1 k	100	2 k	200	4 k	500	10 k	1 k	20 k
3 s	20	600	50	1.5 k	100	3 k	200	6 k	500	15 k
4 s	20	800	50	2 k	100	4 k	200	8 k	500	20 k
5 s	20	1 k	50	2.5 k	100	5 k	200	10 k	500	25 k
6 s	10	600	20	1.2 k	50	3 k	100	6 k	200	12 k
8 s	10	800	20	1.6 k	50	4 k	100	8 k	200	16 k
10 s	10	1 k	20	2 k	50	5 k	100	10 k	200	20 k
20 s	5	1 k	10	2 k	20	4 k	50	10 k	100	20 k
30 s			5	1.5 k	10	3 k	20	6 k	50	15 k
1 min					5	3 k	10	6 k	20	12 k
2 min							5	6 k	20	24 k
3 min							5	9 k	10	18 k
4 min									10	24 k
5 min									5	15 k
6 min									5	18 k
7 min									5	21 k

When the time axis setting is 100 ms or greater (the settings surrounded by bold lines) and the trigger mode is Auto or Auto Level, waveforms are displayed in roll mode.

When the Record Length Is 50 kpoint, 100 kpoint, 250 kpoint, 500 kpoint, or 1 Mpoint

Time/div	Record Length									
	50 kpoint		100 kpoint		250 kpoint		500 kpoint		1 Mpoint	
	Sample Rate (S/s)	Display Record Length (Points)	Sample Rate (S/s)	Display Record Length (Points)	Sample Rate (S/s)	Display Record Length (Points)	Sample Rate (S/s)	Display Record Length (Points)	Sample Rate (S/s)	Display Record Length (Points)
1 μs	10 M	100	10 M	100	10 M	100	10 M	100	10 M	100
2 μs	10 M	200	10 M	200	10 M	200	10 M	200	10 M	200
5 μs	10 M	500	10 M	500	10 M	500	10 M	500	10 M	500
10 μs	10 M	1 k	10 M	1 k	10 M	1 k	10 M	1 k	10 M	1 k
20 μs	10 M	2 k	10 M	2 k	10 M	2 k	10 M	2 k	10 M	2 k
50 μs	10 M	5 k	10 M	5 k	10 M	5 k	10 M	5 k	10 M	5 k
100 μs	10 M	10 k	10 M	10 k	10 M	10 k	10 M	10 k	10 M	10 k
200 μs	10 M	20 k	10 M	20 k	10 M	20 k	10 M	20 k	10 M	20 k
500 μs	10 M	50 k	10 M	50 k	10 M	50 k	10 M	50 k	10 M	50 k
1 ms	5 M	50 k	10 M	100 k	10 M	100 k	10 M	100 k	10 M	100 k
2 ms	2 M	40 k	5 M	100 k	10 M	200 k	10 M	200 k	10 M	200 k
5 ms	1 M	50 k	2 M	100 k	5 M	250 k	10 M	500 k	10 M	500 k
10 ms	500 k	50 k	1 M	100 k	2 M	200 k	5 M	500 k	10 M	1 M
20 ms	200 k	40 k	500 k	100 k	1 M	200 k	2 M	400 k	5 M	1 M
50 ms	100 k	50 k	200 k	100 k	500 k	250 k	1 M	500 k	2 M	1 M
100 ms	50 k	50 k	100 k	100 k	200 k	200 k	500 k	500 k	1 M	1 M
200 ms	20 k	40 k	50 k	100 k	100 k	200 k	200 k	400 k	500 k	1 M
500 ms	10 k	50 k	20 k	100 k	50 k	250 k	100 k	500 k	200 k	1 M
1 s	5 k	50 k	10 k	100 k	20 k	200 k	50 k	500 k	100 k	1 M
2 s	2 k	40 k	5 k	100 k	10 k	200 k	20 k	400 k	50 k	1 M
3 s	1 k	30 k	2 k	60 k	5 k	150 k	10 k	300 k	20 k	600 k
4 s	1 k	40 k	2 k	80 k	5 k	200 k	10 k	400 k	20 k	800 k
5 s	1 k	50 k	2 k	100 k	5 k	250 k	10 k	500 k	20 k	1 M
6 s	500	30 k	1 k	60 k	2 k	120 k	5 k	300 k	10 k	600 k
8 s	500	40 k	1 k	80 k	2 k	160 k	5 k	400 k	10 k	800 k
10 s	500	50 k	1 k	100 k	2 k	200 k	5 k	500 k	10 k	1 M
20 s	200	40 k	500	100 k	1 k	200 k	2 k	400 k	5 k	1 M
30 s	100	30 k	200	60 k	500	150 k	1 k	300 k	2 k	600 k
1 min	50	30 k	100	60 k	200	120 k	500	300 k	1 k	600 k
2 min	20	24 k	50	60 k	200	240 k	200	240 k	500	600 k
3 min	20	36 k	50	90 k	100	180 k	200	360 k	500	900 k
4 min	20	48 k	20	48 k	100	240 k	200	480 k	200	480 k
5 min	10	30 k	20	60 k	50	150 k	100	300 k	200	600 k
6 min	10	36 k	20	72 k	50	180 k	100	360 k	200	720 k
7 min	10	42 k	20	84 k	50	210 k	100	420 k	200	840 k
8 min	10	48 k	20	96 k	50	240 k	100	480 k	200	960 k
9 min	5	27 k	10	54 k	20	108 k	50	270 k	100	540 k
10 min	5	30 k	10	60 k	20	120 k	50	300 k	100	600 k
12 min	5	36 k	10	72 k	20	144 k	50	360 k	100	720 k
15 min	5	45 k	10	90 k	20	180 k	50	450 k	100	900 k
30 min			5	90 k	10	180 k	20	360 k	50	900 k
1 h					5	180 K	10	360 k	20	720 k
2 h							5	360 k	10	720 k
3 h									5	540 k
4 h									5	720 k
5 h									5	900 k

When the time axis setting is 100 ms or greater (the settings surrounded by bold lines) and the trigger mode is Auto or Auto Level, waveforms are displayed in roll mode.



Appendix 1 Relationship between the Time Axis Setting, Record Length, and Sample Rate

When the Record Length Is 2.5 Mpoint, 5 Mpoint, 10 Mpoint, 25 Mpoint, or 50 Mpoint

Time/div	Record Length									
	2.5 Mpoint		5 Mpoint		10 Mpoint		25 Mpoint		50 Mpoint	
	Sample Rate (S/s)	Display Record Length (Points)	Sample Rate (S/s)	Display Record Length (Points)	Sample Rate (S/s)	Display Record Length (Points)	Sample Rate (S/s)	Display Record Length (Points)	Sample Rate (S/s)	Display Record Length (Points)
1 µs	10 M	100	10 M	100	10 M	100	10 M	100	10 M	100
2 µs	10 M	200	10 M	200	10 M	200	10 M	200	10 M	200
5 µs	10 M	500	10 M	500	10 M	500	10 M	500	10 M	500
10 µs	10 M	1 k	10 M	1 k	10 M	1 k	10 M	1 k	10 M	1 k
20 µs	10 M	2 k	10 M	2 k	10 M	2 k	10 M	2 k	10 M	2 k
50 µs	10 M	5 k	10 M	5 k	10 M	5 k	10 M	5 k	10 M	5 k
100 µs	10 M	10 k	10 M	10 k	10 M	10 k	10 M	10 k	10 M	10 k
200 µs	10 M	20 k	10 M	20 k	10 M	20 k	10 M	20 k	10 M	20 k
500 µs	10 M	50 k	10 M	50 k	10 M	50 k	10 M	50 k	10 M	50 k
1 ms	10 M	100 k	10 M	100 k	10 M	100 k	10 M	100 k	10 M	100 k
2 ms	10 M	200 k	10 M	200 k	10 M	200 k	10 M	200 k	10 M	200 k
5 ms	10 M	500 k	10 M	500 k	10 M	500 k	10 M	500 k	10 M	500 k
10 ms	10 M	1 M	10 M	1 M	10 M	1 M	10 M	1 M	10 M	1 M
20 ms	10 M	2 M	10 M	2 M	10 M	2 M	10 M	2 M	10 M	2 M
50 ms	5 M	2.5 M	10 M	5 M	10 M	5 M	10 M	5 M	10 M	5 M
100 ms	2 M	2 M	5 M	5 M	10 M	10 M	10 M	10 M	10 M	10 M
200 ms	1 M	2 M	2 M	4 M	5 M	10 M	10 M	20 M	10 M	20 M
500 ms	500 k	2.5 M	1 M	5 M	2 M	10 M	5 M	25 M	10 M	50 M
1 s	200 k	2 M	500 k	5 M	1 M	10 M	2 M	20 M	5 M	50 M
2 s	100 k	2 M	200 k	4 M	500 k	10 M	1 M	20 M	2 M	40 M
3 s	50 k	1.5 M	100 k	3 M	200 k	6 M	500 k	15 M	1 M	30 M
4 s	50 k	2 M	100 k	4 M	200 k	8 M	500 k	20 M	1 M	40 M
5 s	50 k	2.5 M	100 k	5 M	200 k	10 M	500 k	25 M	1 M	50 M
6 s	20 k	1.2 M	50 k	3 M	100 k	6 M	200 k	12 M	500 k	30 M
8 s	20 k	1.6 M	50 k	4 M	100 k	8 M	200 k	16 M	500 k	40 M
10 s	20 k	2 M	50 k	5 M	100 k	10 M	200 k	20 M	500 k	50 M
20 s	10 k	2 M	20 k	4 M	50 k	10 M	100 k	20 M	200 k	40 M
30 s	5 k	1.5 M	10 k	3 M	20 k	6 M	50 k	15 M	100 k	30 M
1 min	2 k	1.2 M	5 k	3 M	10 k	6 M	20 k	12 M	50 k	30 M
2 min	2 k	2.4 M	2 k	2.4 M	5 k	6 M	20 k	24 M	20 k	24 M
3 min	1 k	1.8 M	2 k	3.6 M	5 k	9 M	10 k	18 M	20 k	36 M
4 min	1 k	2.4 M	2 k	4.8 M	2 k	4.8 M	10 k	24 M	20 k	48 M
5 min	500	1.5 M	1 k	3 M	2 k	6 M	5 k	15 M	10 k	30 M
6 min	500	1.8 M	1 k	3.6 M	2 k	7.2 M	5 k	18 M	10 k	36 M
7 min	500	2.1 M	1 k	4.2 M	2 k	8.4 M	5 k	21 M	10 k	42 M
8 min	500	2.4 M	1 k	4.8 M	2 k	9.6 M	5 k	24 M	10 k	48 M
9 min	200	1.08 M	500	2.7 M	1 k	5.4 M	2 k	10.8 M	5 k	27 M
10 min	200	1.2 M	500	3 M	1 k	6 M	2 k	12 M	5 k	30 M
12 min	200	1.44 M	500	3.6 M	1 k	7.2 M	2 k	14.4 M	5 k	36 M
15 min	200	1.8 M	500	4.5 M	1 k	9 M	2 k	18 M	5 k	45 M
30 min	100	1.8 M	200	3.6 M	500	9 M	1 k	18 M	2 k	36 M
1 h	50	1.8 M	100	3.6 M	200	7.2 M	500	18 M	1 k	36 M
2 h	20	1.44 M	50	3.6 M	100	7.2 M	200	14.4 M	500	36 M
3 h	20	2.16 M	20	2.16 M	50	5.4 M	200	21.6 M	200	21.6 M
4 h	10	1.44 M	20	2.88 M	50	7.2 M	100	14.4 M	200	28.8 M
5 h	10	1.8 M	20	3.6 M	50	9 M	100	18 M	200	36 M
6 h	10	2.16 M	20	4.32 M	20	4.32 M	100	21.6 M	200	43.2 M
7 h	5	1.26 M	10	2.52 M	20	5.04 M	50	12.6 M	100	25.2 M
8 h	5	1.44 M	10	2.88 M	20	5.76 M	50	14.4 M	100	28.8 M
9 h	5	1.62 M	10	3.24 M	20	6.48 M	50	16.2 M	100	32.4 M
10 h	5	1.8 M	10	3.6 M	20	7.2 M	50	18 M	100	36 M
12 h	5	2.16 M	10	4.32 M	20	8.64 M	50	21.6 M	100	43.2 M
1 day			5	4.32 M	10	8.64 M	20	17.28 M	50	43.2 M
2 days					5	8.64 M	10	17.28 M	20	34.56 M
3 days							5	12.96 M	10	25.92 M

When the time axis setting is 100 ms or greater (the settings surrounded by bold lines) and the trigger mode is Auto or Auto Level, waveforms are displayed in roll mode.

When the Record Length Is 100 Mpoint, 250 Mpoint, 500 Mpoint, 1 Gpoint, or 2 Gpoint

Time/div	Record Length									
	100 Mpoint		250 Mpoint		500 Mpoint		1 Gpoint		2 Gpoint	
	Sample Rate (S/s)	Display Record Length (Points)	Sample Rate (S/s)	Display Record Length (Points)	Sample Rate (S/s)	Display Record Length (Points)	Sample Rate (S/s)	Display Record Length (Points)	Sample Rate (S/s)	Display Record Length (Points)
1 μs	10 M	100	10 M	100	10 M	100	10 M	100	10 M	100
2 μs	10 M	200	10 M	200	10 M	200	10 M	200	10 M	200
5 μs	10 M	500	10 M	500	10 M	500	10 M	500	10 M	500
10 μs	10 M	1 k	10 M	1 k	10 M	1 k	10 M	1 k	10 M	1 k
20 μs	10 M	2 k	10 M	2 k	10 M	2 k	10 M	2 k	10 M	2 k
50 μs	10 M	5 k	10 M	5 k	10 M	5 k	10 M	5 k	10 M	5 k
100 μs	10 M	10 k	10 M	10 k	10 M	10 k	10 M	10 k	10 M	10 k
200 μs	10 M	20 k	10 M	20 k	10 M	20 k	10 M	20 k	10 M	20 k
500 μs	10 M	50 k	10 M	50 k	10 M	50 k	10 M	50 k	10 M	50 k
1 ms	10 M	100 k	10 M	100 k	10 M	100 k	10 M	100 k	10 M	100 k
2 ms	10 M	200 k	10 M	200 k	10 M	200 k	10 M	200 k	10 M	200 k
5 ms	10 M	500 k	10 M	500 k	10 M	500 k	10 M	500 k	10 M	500 k
10 ms	10 M	1 M	10 M	1 M	10 M	1 M	10 M	1 M	10 M	1 M
20 ms	10 M	2 M	10 M	2 M	10 M	2 M	10 M	2 M	10 M	2 M
50 ms	10 M	5 M	10 M	5 M	10 M	5 M	10 M	5 M	10 M	5 M
100 ms	10 M	10 M	10 M	10 M	10 M	10 M	10 M	10 M	10 M	10 M
200 ms	10 M	20 M	10 M	20 M	10 M	20 M	10 M	20 M	10 M	20 M
500 ms	10 M	50 M	10 M	50 M	10 M	50 M	10 M	50 M	10 M	50 M
1 s	10 M	100 M	10 M	100 M	10 M	100 M	10 M	100 M	10 M	100 M
2 s	5 M	100 M	10 M	200 M	10 M	200 M	10 M	200 M	10 M	200 M
3 s	2 M	60 M	5 M	150 M	10 M	300 M	10 M	300 M	10 M	300 M
4 s	2 M	80 M	5 M	200 M	10 M	400 M	10 M	400 M	10 M	400 M
5 s	2 M	100 M	5 M	250 M	10 M	500 M	10 M	500 M	10 M	500 M
6 s	1 M	60 M	2 M	120 M	5 M	300 M	10 M	600 M	10 M	600 M
8 s	1 M	80 M	2 M	160 M	5 M	400 M	10 M	800 M	10 M	800 M
10 s	1 M	100 M	2 M	200 M	5 M	500 M	10 M	1 G	10 M	1 G
20 s	500 k	100 M	1 M	200 M	2 M	400 M	5 M	1 G	10 M	2 G
30 s	200 k	60 M	500 k	150 M	1 M	300 M	2 M	600 M	5 M	1.5 G
1 min	100 k	60 M	200 k	120 M	500 k	300 M	1 M	600 M	2 M	1.2 G
2 min	50 k	60 M	200 k	240 M	200 k	240 M	500 k	600 M	1 M	1.2 G
3 min	50 k	90 M	100 k	180 M	200 k	360 M	500 k	900 M	1 M	1.8 G
4 min	20 k	48 M	100 k	240 M	200 k	480 M	200 k	480 M	500 k	1.2 G
5 min	20 k	60 M	50 k	150 M	100 k	300 M	200 k	600 M	500 k	1.5 G
6 min	20 k	72 M	50 k	180 M	100 k	360 M	200 k	720 M	500 k	1.8 G
7 min	20 k	84 M	50 k	210 M	100 k	420 M	200 k	840 M	200 k	840 M
8 min	20 k	96 M	50 k	240 M	100 k	480 M	200 k	960 M	200 k	960 M
9 min	10 k	54 M	20 k	108 M	50 k	270 M	100 k	540 M	200 k	1.08 G
10 min	10 k	60 M	20 k	120 M	50 k	300 M	100 k	600 M	200 k	1.2 G
12 min	10 k	72 M	20 k	144 M	50 k	360 M	100 k	720 M	200 k	1.44 G
15 min	10 k	90 M	20 k	180 M	50 k	450 M	100 k	900 M	200 k	1.8 G
30 min	5 k	90 M	10 k	180 M	20 k	360 M	50 k	900 M	100 k	1.8 G
1 h	2 k	72 M	5 k	180 M	10 k	360 M	20 k	720 M	50 k	1.8 G
2 h	1 k	72 M	2 k	144 M	5 k	360 M	10 k	720 M	20 k	1.44 G
3 h	500	54 M	2 k	216 M	2 k	216 M	5 k	540 M	10 k	1.08 G
4 h	500	72 M	1 k	144 M	2 k	288 M	5 k	720 M	10 k	1.44 G
5 h	500	90 M	1 k	180 M	2 k	360 M	5 k	900 M	10 k	1.8 G
6 h	200	43.2 M	1 k	216 M	2 k	432 M	2 k	432 M	5 k	1.08 G
7 h	200	50.4 M	500	126 M	1 k	252 M	2 k	504 M	5 k	1.26 G
8 h	200	57.6 M	500	144 M	1 k	288 M	2 k	576 M	5 k	1.44 G
9 h	200	64.8 M	500	162 M	1 k	324 M	2 k	648 M	5 k	1.62 G
10 h	200	72 M	500	180 M	1 k	360 M	2 k	720 M	5 k	1.8 G
12 h	200	86.4 M	500	216 M	1 k	432 M	2 k	864 M	2 k	864 M
1 day	100	86.4 M	200	172.8 M	500	432 M	1 k	864 M	2 k	1.728 G
2 days	50	86.4 M	100	172.8 M	200	345.6 M	500	864 M	1 k	1.728 G
3 days	20	51.84 M	50	129.6 M	100	259.2 M	200	518.4 M	500	1.296 G

When the time axis setting is 100 ms or greater (the settings surrounded by bold lines) and the trigger mode is Auto or Auto Level, waveforms are displayed in roll mode.

Appendix 1 Relationship between the Time Axis Setting, Record Length, and Sample Rate

When the Record Length Is 4 Gpoint, 5 Gpoint, 10 Gpoint, 20 Gpoint, or 50 Gpoint

Time/div	Record Length									
	4 Gpoint		5 Gpoint		10 Gpoint		20 Gpoint		50 Gpoint	
	Sample Rate (S/s)	Display Record Length (Points)	Sample Rate (S/s)	Display Record Length (Points)	Sample Rate (S/s)	Display Record Length (Points)	Sample Rate (S/s)	Display Record Length (Points)	Sample Rate (S/s)	Display Record Length (Points)
1 µs										
2 µs										
5 µs										
10 µs										
20 µs										
50 µs										
100 µs										
200 µs										
500 µs										
1 ms										
2 ms										
5 ms										
10 ms										
20 ms										
50 ms										
100 ms										
200 ms										
500 ms										
1 s										
2 s										
3 s										
4 s										
5 s										
6 s										
8 s										
10 s										
20 s										
30 s										
1 min										
2 min										
3 min										
4 min	1 M	2.4 G								
5 min	1 M	3 G	1 M	3 G						
6 min	1 M	3.6 G	1 M	3.6 G						
7 min	500 k	2.1 G	1 M	4.2 G						
8 min	500 k	2.4 G	1 M	4.8 G						
9 min	500 k	2.7 G	500 k	2.7 G	1 M	5.4 G				
10 min	500 k	3 G	500 k	3 G	1 M	6 G				
12 min	500 k	3.6 G	500 k	3.6 G	1 M	7.2 G				
15 min	200 k	1.8 G	500 k	4.5 G	1 M	9 G				
30 min	200 k	3.6 G	200 k	3.6 G	500 k	9 G	1 M	18 G		
1 h	100 k	3.6 G	100 k	3.6 G	200 k	7.2 G	500 k	18 G	1 M	36 G
2 h	50 k	3.6 G	50 k	3.6 G	100 k	7.2 G	200 k	14.4 G	500 k	36 G
3 h	20 k	2.16 G	20 k	2.16 G	50 k	5.4 G	100 k	10.8 G	200 k	21.6 G
4 h	20 k	2.88 G	20 k	2.88 G	50 k	7.2 G	100 k	14.4 G	200 k	28.8 G
5 h	20 k	3.6 G	20 k	3.6 G	50 k	9 G	100 k	18 G	200 k	36 G
6 h	10 k	2.16 G	20 k	4.32 G	20 k	4.32 G	50 k	10.8 G	200 k	43.2 G
7 h	10 k	2.52 G	10 k	2.52 G	20 k	5.04 G	50 k	12.6 G	100 k	25.2 G
8 h	10 k	2.88 G	10 k	2.88 G	20 k	5.76 G	50 k	14.4 G	100 k	28.8 G
9 h	10 k	3.24 G	10 k	3.24 G	20 k	6.48 G	50 k	16.2 G	100 k	32.4 G
10 h	10 k	3.6 G	10 k	3.6 G	20 k	7.2 G	50 k	18 G	100 k	36 G
12 h	5 k	2.16 G	10 k	4.32 G	20 k	8.64 G	20 k	8.64 G	100 k	43.2 G
1 day	2 k	1.728 G	5 k	4.32 G	10 k	8.64 G	20 k	17.28 G	50 k	43.2 G
2 days	2 k	3.456 G	2 k	3.456 G	5 k	8.64 G	10 k	17.28 G	20 k	34.56 G
3 days	1 k	2.592 G	1 k	2.592 G	2 k	5.184 G	5 k	12.96 G	10 k	25.9 G

When the time axis setting is 100 ms or greater (the settings surrounded by bold lines) and the trigger mode is Auto or Auto Level, waveforms are displayed in roll mode.

## Relationship between the Main Channel Sample Rate and the Sub Channel Sample Rates of the 16-CH Voltage Input Module

Main Channel Sample Rate (S/s)	Number of Sub Channels				
	1	2	3 to 4	5 to 8	9 to 16
	Maximum Sample Rate				
	200 k	100 k	50 k	20 k	10 k
100 M	500 k	500 k	500 k	500 k	500 k
50 M	500 k	500 k	500 k	500 k	500 k
20 M	500 k	500 k	500 k	500 k	500 k
10 M	500 k	500 k	500 k	500 k	500 k
5 M	500 k	500 k	500 k	500 k	200 k
2 M	500 k	500 k	500 k	200 k	100 k
1 M	500 k	500 k	200 k	100 k	50 k
500 k	500 k	100 k	100 k	50 k	20 k
200 k	200 k	100 k	50 k	20 k	10 k
100 k	100 k	50 k	20 k	10 k	5 k
50 k	50 k	10 k	10 k	5 k	2 k
20 k	20 k	10 k	5 k	2 k	1 k
10 k	10 k	5 k	2 k	1 k	500
5 k	5 k	1 k	1 k	500	200
2 k	2 k	1 k	500	200	100
1 k	1 k	500	200	100	50
500	500	100	100	50	20
200	200	100	50	20	10
100	100	50	20	10	5
50	50	10	10	5	2
20	20	10	5	2	1
10	10	5	2	1	-
5	5	1	1	-	-

The bold lines surround the actual sampling range.

## Relationship between the Main Channel Sample Rate and the Sub Channel Sample Rates of the CAN Bus Monitor Module

Main Channel Sample Rate (S/s)	Number of Sub Channels				
	1	2	3 to 4	5 to 8	9 to 16
	Maximum Sample Rate				
	100 k	100 k	100 k	100 k	100 k
100 M	100 k	100 k	100 k	100 k	100 k
50 M	100 k	100 k	100 k	100 k	100 k
20 M	100 k	100 k	100 k	100 k	100 k
10 M	100 k	100 k	100 k	100 k	100 k
5 M	100 k	100 k	100 k	100 k	100 k
2 M	100 k	100 k	100 k	100 k	100 k
1 M	100 k	100 k	100 k	100 k	50 k
500 k	100 k	100 k	100 k	50 k	20 k
200 k	100 k	100 k	50 k	20 k	10 k
100 k	100 k	50 k	20 k	10 k	5 k
50 k	50 k	10 k	10 k	5 k	2 k
20 k	20 k	10 k	5 k	2 k	1 k
10 k	10 k	5 k	2 k	1 k	500
5 k	5 k	1 k	1 k	500	200
2 k	2 k	1 k	500	200	100
1 k	1 k	500	200	100	50
500	500	100	100	50	20
200	200	100	50	20	10
100	100	50	20	10	5
50	50	10	10	5	2
20	20	10	5	2	1
10	10	5	2	1	-
5	5	1	1	-	-

## Appendix 2 Relationship between the Record Length and the Acquisition Mode

### Maximum Record Length That Can Be Set

The maximum record length varies as indicated below for each model depending on the number of displayed channels.

#### When Dual Capturing and Hard Disk Recording Are Off

Number of Displayed Channels	Model		
	Standard	/M1 (1 G)	/M2 (2 G)
9 to 16 channels	10 M	50 M	100 M
5 to 8 channels	25 M	100 M	250 M
3 to 4 channels	50 M	250 M	500 M
2 channels	100 M	500 M	1 G
1 channel	250 M	1 G	2 G

Unit of record length: Point

#### When Dual Capturing Is Off and Hard Disk Recording Is On

Number of Displayed Channels	Model		
	Standard	/M1 (1 G)	/M2 (2 G)
9 to 16 channels	500 M	5 G	5 G
5 to 8 channels	1 G	10 G	10 G
3 to 4 channels	2 G	20 G	20 G
2 channels	5 G	20 G	20 G
1 channel	10 G	50 G	50 G

Unit of record length: Point

#### When Dual Capturing Is On and Hard Disk Recording Is Off

Number of Displayed Channels	Model		
	Standard	/M1 (1 G)	/M2 (2 G)
9 to 16 channels	5 M	25 M	50 M
5 to 8 channels	10 M	50 M	100 M
3 to 4 channels	25 M	100 M	250 M
2 channels	50 M	250 M	500 M
1 channel	100 M	500 M	1 G

Unit of record length: Point

#### When Dual Capturing and Hard Disk Recording Are On

Number of Displayed Channels	Model		
	Standard	/M1 (1 G)	/M2 (2 G)
9 to 16 channels	500 M	2 G	5 G
5 to 8 channels	1 G	5 G	10 G
3 to 4 channels	2 G	10 G	20 G
2 channels	5 G	20 G	20 G
1 channel	10 G	20 G	50 G

Unit of record length: Point

## Maximum Number of History Waveform Acquisitions

The maximum number of acquisitions varies for each module as indicated below.

Record Length	Model		
	Standard	/M1 (1 G)	/M2 (2 G)
1 k	5000	5000	5000
2.5 k	5000	5000	5000
5 k	2976	5000	5000
10 k	1487	5000	5000
25 k	593	2381	5000
50 k	295	1189	2381
100 k	144	583	1168
250 k	57	236	474
500 k	28	116	235
1 M	13	54	111
2.5 M	4	22	46
5 M	1	10	22
10 M	1	4	10
25 M	1 <sup>*1</sup>	1	4
50 M	1 <sup>*2</sup>	1	1
100 M	1 <sup>*3</sup>	1 <sup>*1</sup>	1
250 M	1 <sup>*4</sup>	1 <sup>*2</sup>	1 <sup>*1</sup>
500 M	0	1 <sup>*3</sup>	1 <sup>*2</sup>
1 G	0	1 <sup>*4</sup>	1 <sup>*3</sup>
2 G	0	0	1 <sup>*4</sup>

Unit of record length: Point

- 1 When there are eight displayed channels
- 2 When there are four displayed channels
- 3 When there are two displayed channels
- 4 When there is one displayed channel

## Maximum Sample Rate at Which Hard Disk Recording Is Possible

The maximum sample rate varies as indicated below depending on the number of channels that are recorded.

Maximum Number of Channels	Maximum Sample Rate
16 channels	100 kS/s
8 channels	200 kS/s
3 channels	500 kS/s
1 channel	1 MS/s

# Appendix 3 Default Values

Operation Key	Soft Key	Setting
<b>CH1 to 16 (HS10M12 (701250))</b>		
	V/div	50.0 V/div
	Position	0.00 div
	Label	Channel number
	Coupling	DC
	Probe	10:1
	BandWidth	Full
	V Scale	DIV
	V Zoom	×1
	Offset	0.0 V
	InVert	OFF
	Linear Scale	OFF
<b>CH1 to 16 (HS1M16 (701251))</b>		
	V/div	50.0 V/div
	Position	0.00 div
	Label	Channel number
	Coupling	DC
	Probe	10:1
	BandWidth	Full
	V Scale	DIV
	V Zoom	×1
	Offset	0.00 V
	InVert	OFF
	Linear Scale	OFF
<b>CH1 to 16 (NONISO_10M12 (701255))</b>		
	V/div	50.0 V/div
	Position	0.00 div
	Label	Channel number
	Coupling	DC
	Probe	10:1
	BandWidth	Full
	V Scale	DIV
	V Zoom	×1
	Offset	0.0 V
	InVert	OFF
	Linear Scale	OFF
<b>CH1 to 16 (HV (with RMS) (701260))</b>		
	V/div	5.000 V/div
	Position	0.00 div
	Label	Channel number
	Coupling	DC
	Probe	1:1
	BandWidth	Full
	V Scale	DIV
	V Zoom	×1
	Offset	0.000 V
	InVert	OFF
	Linear Scale	OFF
<b>CH1 to 16 (UNIVERSAL (701261)/UNIVERSAL (AAF) (701262))</b>		
	V/div	5.000 V/div
	Position	0.00 div
	Label	Channel number
	Coupling	DC
	BandWidth	Full
	V Scale	DIV
	V Zoom	×1

Operation Key	Soft Key	Setting
<b>CH1 to 16 (UNIVERSAL (701261)/UNIVERSAL (AAF) (701262))</b>		
	Offset	0.000 V
	InVert	OFF
	Linear Scale	OFF
<b>CH1 to 16 (TEMP/HPV (701265))</b>		
	V/div	5.000 V/div
	Position	0.00 div
	Label	Channel number
	Coupling	DC
	BandWidth	Full
	V Scale	DIV
	V Zoom	×1
	Offset	0.000 V
	InVert	OFF
	Linear Scale	OFF
<b>CH1 to 16 (STRAIN_NDIS (701270)/STRAIN_DSUB (701271))</b>		
	Value/div	4000.0 μSTR/div
	Range	±20000 μSTR
	Label	Channel number
	Excitation	2 V
	Gauge Factor	2.00
	BandWidth	Full
	Upper	20000 μSTR
	Lower	-20000 μSTR
	Range Unit	μSTR
	InVert	OFF
	Linear Scale	OFF
<b>CH1 to 16 (ACCL/VOLT (701275))</b>		
	V/div	50.0 V/div
	Position	0.00 div
	Label	Channel number
	Coupling	DC
	Probe	10:1
	BandWidth	Full
	V Scale	DIV
	V Zoom	×1
	Offset	0.00 V
	InVert	OFF
	Linear Scale	OFF
<b>CH1 to 16 (FREQ (701280))</b>		
	Value/div	1 kHz/div
	Position	0.00 div
	Label	Channel number
	FV Setup	Frequency
	Input Setup	User
	V Scale	DIV
	V Zoom	×1
	Offset	0.000 Hz
	Linear Scale	OFF
<b>CH1 to 16 (HS100M12 (720210))</b>		
	V/div	50.0 V/div
	Position	0.00 div
	Label	Channel number
	Coupling	DC
	Probe	10:1
	BandWidth	Full



### Appendix 3 Default Values

Operation Key	Soft Key	Setting
	V Scale	DIV
	V Zoom	×1
	Offset	0.0 V
	InVert	OFF
	Linear Scale	OFF
<b>CH1 to 16 (16CH VOLT (720220))</b>		
	V/div	2.000 V/div
	Position	0.00 div
	Label	Channel number
	Coupling	DC
	BandWidth	Full
	V Scale	DIV
	V Zoom	×1
	Offset	0 mV
	InVert	OFF
	Linear Scale	OFF
<b>CH1 to 16 (LOGIC (720230))</b>		
	Position	0.00 div
	Label	Channel number
	Bit Mapping	Auto
<b>CH13 to 16 (CAN MONITOR (720240))</b>		
	All SubChannels Setup	
	Input	OFF
	Label	Channel number
	Message Format	STD
	ID (Hex)	000
	Byte Count	Auto
	Start Bit	0
	Bit Count	1
	Byte Order	Big
	Value Type	Unsigned
	Factor	1.0000
	Offset	0.0000
	Port Setup	
	Bit Rate	500 Kbps
	Sample Point	85%
	Sync Jump Width	2
	Bit Sample Num	1
	Listen Only	OFF
	Terminator	OFF
	Scale	Auto
	One Shot Out	
	Message Format	STD
	ID (Hex)	000
	Frame	Data
	DLC	0
	Data (Hex)	00 00 00 00 00 00 00 00
<b>START/STOP</b>		
		STOP
<b>TIME/DIV</b>		
		1 ms/div
<b>ACQUIRE</b>		
	Record Length	10 k
	Acquisition Mode	Normal
	Trigger Mode	Auto
	Acquisition Count	Infinite
	HD Recording	OFF
	Time Base	Int
<b>DUAL CAPTURE</b>		
	Mode	OFF

Operation Key	Soft Key	Setting
	Capture Setup	
	Time/div	100 µs/div
	Capture Length	10 k
	Capture Mode	Auto
	Select Number	Current
	Mag	100 µs/div
	Position	0.0 div
	Window	ON
	Main Ratio	50%
	Window Layout	Side
	Format	Main
	Event Display	OFF
<b>FILE</b>		
	Save_Waveform	
	Auto Naming	Numbering
	Data Type	Binary
	Range	Main
	Save_Setup	
	Auto Naming	Numbering
	Save_Others	
	Auto Naming	Numbering
	Data Type	Screen Image
	Format	PNG
	Color	ON
<b>MENU</b>		
	Data Save	OFF
	Data Save Setup	
	Auto Naming	Numbering
	Data Type	Binary
	Image Save	OFF
	Image Save Setup	
	Auto Naming	Numbering
	Image Format	PNG
	Color	ON
	Back Ground	Normal
<b>DISPLAY</b>		
	Format	Quad
	Extra Window	OFF
	Graticule	Grid
	Scale Value	ON
	Setup	
	Allocation Mode	Auto
	Trace Label	OFF
	Dot Connect	Line
	Accumulate	OFF
	Manual Event	OFF
	Ch. Information	Narrow
<b>X-Y</b>		
	Window1/2	OFF
	Display	OFF
	Start Point	-5 div
	End Point	5 div
<b>MODE</b>		
		Auto
<b>POSITION/DELAY</b>		
	Position	50.0%
	Delay	0.0 µs
<b>SIMPLE/ENHANCED</b>		
	Setting	Simple
	Source	CH1
	Slope	Rising
	LeVel	0 V

Operation Key	Soft Key	Setting
	Hysteresis	<del>✓</del>
	Hold Off	0.00 μs
<b>CURSOR</b>		
	Type	OFF
	Horizontal	
	Trace	CH1
	Cursor1	3.00 div
	Cursor2	-3.00 div
	Vertical	
	Trace	CH1
	Cursor1	-4.000 div
	Cursor2	4.000 div
	Marker	
	Marker #	Marker1 X
	Trace	CH1
	Position	-3.000 div
	Marker From	Mark
	Degree	
	Trace	CH1
	Cursor1	-4.000 div
	Cursor2	4.000 div
	RefValue	360
	Ref1	-2.000 div
	Ref2	2.000 div
	H & V	
	Trace	CH1
	V-Cursor1	-4.000 div
	V-Cursor2	4.000 div
	H-Cursor1	3.00 div
	H-Cursor2	-3.00 div
<b>MEASURE</b>		
	Mode	OFF
	Distal/Mesial/Proximal	
	Mode	%
	Distal	90.0%
	Mesial	50.0%
	Proximal	10.0%
	High/Low	Auto
	Delay Setup	
	Mode	OFF
	Polarity	Rising
	Edge Count	1
	Reference	Trace
	Range	Main
	Time Range1	-5.00 div
	Time Range2	5.00 div
	(When Mode is set to ON, Statistics)	
	1-Cycle Mode	OFF
	(When Mode is set to Cycle Statistics)	
	Cycle Trace	CH1

Operation Key	Soft Key	Setting
<b>GO/NO-GO</b>		
	Mode	OFF
	Logic	AND
	ActCondition	Fail
	Sequence	Continue
	Acquisition Count	Infinite
	Remote	OFF
	Beep	OFF
	Print Image	OFF
	Save Data	OFF
	Save Image	OFF
	Send Mail	OFF
	Time Range1	-5.00 div
	Time Range2	5.00 div
<b>HISTORY</b>		
	Display Mode	1 Record
	Select Record	0
	Start Record	0
	End Record	Oldest number
	Search Mode	OFF
<b>MATH</b>		
	Mode	OFF
	Select Math Trace	1
	Opeartion:Math1	OFF
	Opeartion:Math2	OFF
	Opeartion:Math3	OFF
	Opeartion:Math4	OFF
	Opeartion:Math5	OFF
	Opeartion:Math6	OFF
	Opeartion:Math7	OFF
	Opeartion:Math8	OFF
	Scaling Mode	Auto
	Start Point	-5.00 div
	End Point	5.00 div
	FFT Points	1 k
	Window	Hanning
<b>FFT</b>		
	Display	OFF
	Trace	CH1
	Start Point	-5.00 div
	FFT Points	1 k
	Window	Hanning
	Vert. Scale Mode	Auto
	Main Ratio	50%
	Window Layout	Side
	Horiz. Axis	Log Hz
<b>ZOOM</b>		
	Display (Zoom1)	ON
	Display (Zoom2)	OFF
	Position	0.00 div
	Main Ratio	50%
	Window Layout	Side
	Format Zoom1	Main

### Appendix 3 Default Values

Operation Key	Soft Key	Setting
<b>SEARCH</b>		
	Type	Edge
	Edge	
	Trace	CH1
	Level	0.0 V
	Polarity	Rising
	Hysteresis	$\sqrt{\quad}$
	Count	1
	Result Window	Zoom1
	Pattern No.	No Match
	Event	
	Select Number	1
	Result Window	Zoom1
	Select Event	Capture
	Logic Pattern	
	Trace	Installation channel
	Bit Setting	X
	Result Window	Zoom1
	Pattern No.	No Match
	Start Point	-5.00 div
	End Point	5.00 div
	Time	
	Absolute Time	Current date and time
	Result Window	Zoom1
<b>PRINT MENU</b>		
	Print To	Builtin
<b>UTILITY</b>		
	System Config	
	Date/Time	
	Display	ON
	Format	Year/Month/Day
	Time Synchro	
	Time	OFF
	Synchro	
	IRIG Format	A
	Modulation	AM
	Impedance	50
	Language	
	Menu	English
	Message	English
	LCD	
	Auto OFF	OFF
	Auto OFF	1 min
	Time	
	Brightness	3
	Storage Manager	
	Media	HD
	USB Keyboard	English
	USB Function	TMC
	Remote Ctrl	
	Device	USB
	USB Function	TMC
	Network	
	TCP/IP	
	DHCP	ON
	DNS	Auto
	FTP/Web Server	
	User Name	anonymous
	TimeOut(s)	1800

Operation Key	Soft Key	Setting
	Mail	
	Attached	OFF
	Image File	
	TimeOut (s)	15
	Net Print	
	LPR Name	PASSTHRU
	TimeOut (s)	15
	Net Drive	
	LoginName	anonymous
	Passive	OFF
	TimeOut (s)	1800
	SNTP	
	TimeOut (s)	3
	Adjust at	OFF
	PowerON	
	Preference	
	Power On Action	
	Start	OFF
	Action	OFF
	Logic Setup	
	Numerical	Bit
	Format	
	Cursor	1 -> 8
	Order	
	Bit Order	1 -> 8
	Terminal Setup	
	Remote	On
	Stop	
	Trigger Out	Normal
	Pulse Width	1 msec
	Display Setup	
	Menu Font	Large
	Size	
	Base Color	Blue
	Scale Font	Large
	Size	
	Scale On	All
	Item	
	Level	On
	Indicator	
	Intensity	
	Grid	2
	Cursor	8
	Marker	8
	Key/Knob Setup	
	Click Sound	ON
	START/	Quick
	STOP	
	Response	
	Time	
	Key Protect	
	Type	All
	Release	Key
	Type	
	Self Test	Keyboard

## Appendix 4 USB Keyboard Key Assignments

DL850/DL850V	USB Keyboard
AQUIRE	CTRL+A
MATH	CTRL+B
Execute PRINT	CTRL+C or PRINT SCREEN
DISPLAY	CTRL+D
FILE	CTRL+F
HELP	CTRL+G
HISTORY	CTRL+H
Execute SAVE	CTRL+I
MANUALTRIG	CTRL+J
KEY PROTECT	CTRL+K
ALL CH	CTRL+L
MEASURE	CTRL+M
NUM LOCK	CTRL+N
POSITION/DELAY	CTRL+P
Execute CLEAR TRACE	CTRL+Q
Execute RESET	CTRL+R
SHIFT	CTRL+S
MODE (TRIGGER)	CTRL+T
CURSOR	CTRL+U
SIMPLE/ENHANCED	CTRL+W
ZOOM	CTRL+Z
CH1	CTRL+1
CH2	CTRL+2
CH3	CTRL+3
CH4	CTRL+4
CH5	CTRL+5
CH6	CTRL+6
CH7	CTRL+7
CH8	CTRL+8
CH9	CTRL+9
CH10	CTRL+0
SET	CTRL+ENTER
SETUP	CTRL+\
UTILITY	CTRL+/
CH11	CTRL+F1
CH12	CTRL+F2
CH13	CTRL+F3
CH14	CTRL+F4
CH15	CTRL+F5
CH16	CTRL+F6
Turn ZOOM POSITION to the right	CTRL+INSERT
Turn VERTICAL POSITION to the right	CTRL+HOME
Turn ZOOM POSITION to the left	CTRL+DELETE
Turn VERTICAL POSITION to the left	CTRL+END
START/STOP	CTRL+* or F12
DUAL CAPTURE	CTRL+SHIFT+A
FFT	CTRL+SHIFT+B
PRINT MENU	CTRL+SHIFT+C
X-Y	CTRL+SHIFT+D
MENU	CTRL+SHIFT+I
GO/NO-GO	CTRL+SHIFT+M
ACTION	CTRL+SHIFT+T
SEARCH	CTRL+SHIFT+Z
CAL	CTRL+SHIFT+\
EXP (CH key)	E when NUM LOCK is illuminated on the DL850/DL850V
k (CH key) + ENTER (CH key)	K when NUM LOCK is illuminated on the DL850/DL850V
m (CH key) + ENTER (CH key)	M when NUM LOCK is illuminated on the DL850/DL850V

**Appendix 4 USB Keyboard Key Assignments**

<b>DL850/DL850V</b>	<b>USB Keyboard</b>
1 (CH key)	1 when NUM LOCK is illuminated on the DL850/DL850V
2 (CH key)	2 when NUM LOCK is illuminated on the DL850/DL850V
3 (CH key)	3 when NUM LOCK is illuminated on the DL850/DL850V
4 (CH key)	4 when NUM LOCK is illuminated on the DL850/DL850V
5 (CH key)	5 when NUM LOCK is illuminated on the DL850/DL850V
6 (CH key)	6 when NUM LOCK is illuminated on the DL850/DL850V
7 (CH key)	7 when NUM LOCK is illuminated on the DL850/DL850V
8 (CH key)	8 when NUM LOCK is illuminated on the DL850/DL850V
9 (CH key)	9 when NUM LOCK is illuminated on the DL850/DL850V
0 (CH key)	0 when NUM LOCK is illuminated on the DL850/DL850V
ENTER (CH key)	ENTER when NUM LOCK is illuminated on the DL850/ DL850V
. (CH key)	. when NUM LOCK is illuminated on the DL850/DL850V
- (CH key)	- when NUM LOCK is illuminated on the DL850/DL850V
ESC	ESC or F8
Select soft key 1	F1
Select soft key 2	F2
Select soft key 3	F3
Select soft key 4	F4
Select soft key 5	F5
Select soft key 6	F6
Select soft key 7	F7
SNAP SHOT	PAUSE
Turn ZOOM MAG to the right	INSERT
Turn VERTICAL SCALE to the right	HOME
Turn HORIZONTAL TIME/DIV to the right	PAGE UP
Turn ZOOM MAG to the left	DELETE
Turn VERTICAL SCALE to the left	End
Turn HORIZONTAL TIME/DIV to the left	PageDown
Right arrow	→
Left arrow	←
Up arrow	↑
Down arrow	↓

# Appendix 5 Block Diagrams

## Block Diagram of the DL850/DL850V

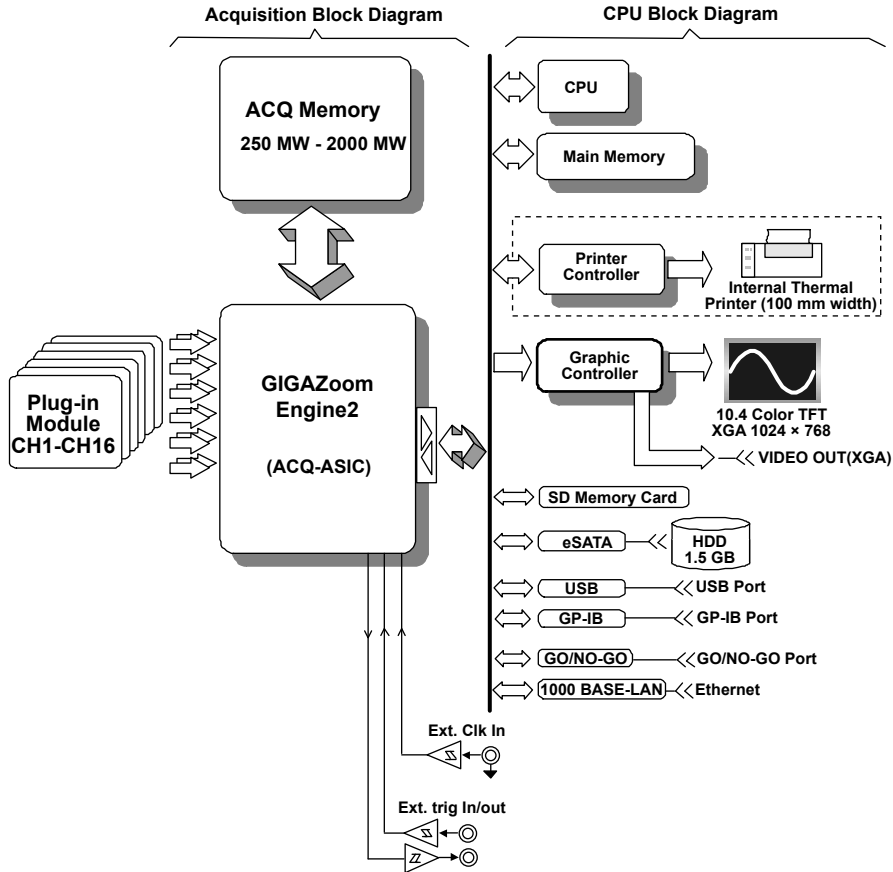

### Signal Flow of the DL850/DL850V

The input terminal signal flow varies for each model. In this example, we will explain the signal flow for the High-Speed 10 MS/s, 12-Bit Isolation Module, 701250 (HS10M12). (For the signal flow of a particular module, see the module's block diagram.)

The input signal applied to the two input terminals is first processed by each module's input section. In the 701250 (HS10M12), the signal is attenuated and amplified by an attenuator (ATT) and amplifier (AMP). Then, the signal's bandwidth is limited by a filter (FLT). Next, the signal is sampled at a rate of 10 MS/s (10,000,000 times a second) by an A/D converter and converted into digital data. Then, the signal passes through an isolator and an ASIC to a waveform-processing ASIC (ACQ-ASIC).

The 16 channel of digital data that is sent to the CPU board passes through the GIGAZoom Engine2 and is stored to the acquisition memory (ACQ Memory). The digital data stored to the ACQ memory is compressed quickly by the GIGAZoom Engine2 waveform processor, and then it passes through a graphic controller and is shown on the XGA TFT color display.

Plug-in Module Block Diagram

701250 (HS10M12)

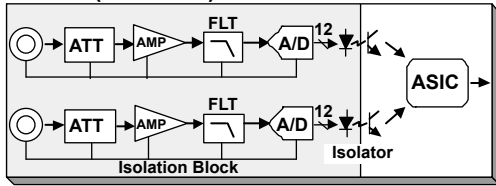

701255 (NONISO\_10M12)

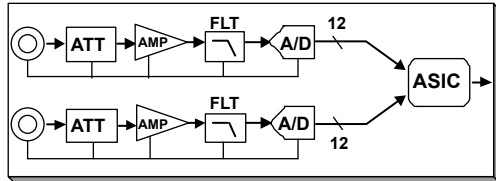

701251 (HS1M16)

701260 (HV (with RMS))

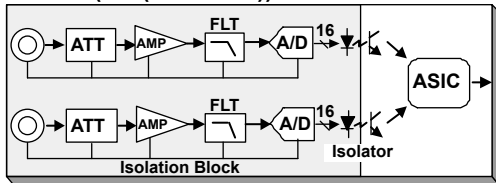

701261 (UNIVERSAL)

701262 (UNIVERSAL (AAF))

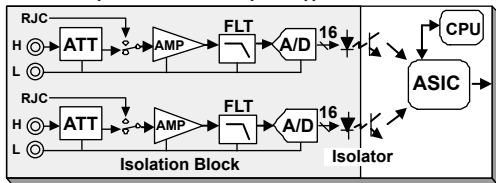

701265 (TEMP/HPV)

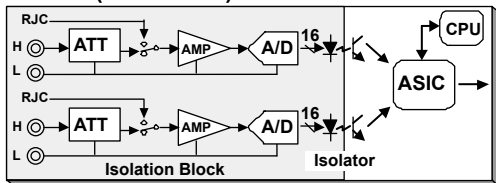

701270 (STRAIN\_NDIS)

701271 (STRAIN\_DSUB)

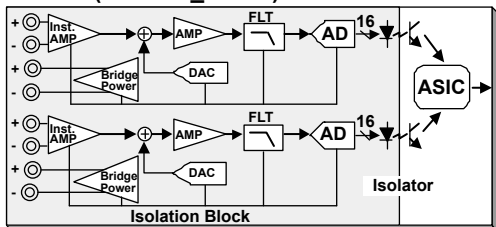

701275 (ACCL/VOLT)

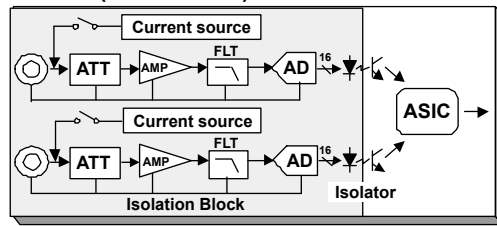

701280 (FREQ)

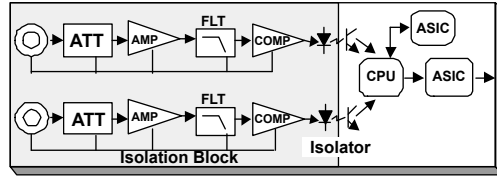

720210 (HS100M12)

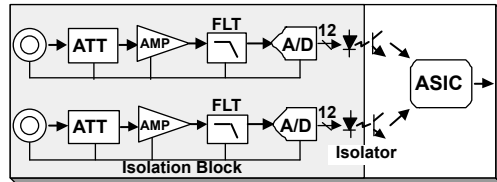

720220 (16CHVOLT)

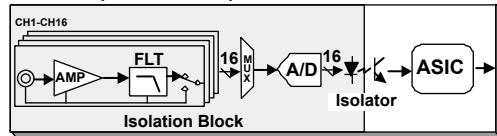

720230 (LOGIC)

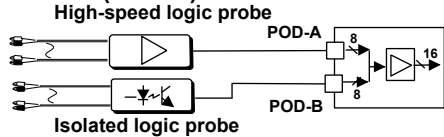

720240 (CAN MONITOR)

