



SPN8878B

N-Channel Enhancement Mode MOSFET

DESCRIPTION

The SPN8878B is the N-Channel logic enhancement mode power field effect transistors are produced using high cell density , DMOS trench technology. The SPN8878B has been designed specifically to improve the overall efficiency of DC/DC converters using either synchronous or conventional switching PWM controllers. It has been optimized for low gate charge, low $R_{DS(ON)}$ and fast switching speed.

FEATURES

- ◆ 30V/20A, $R_{DS(ON)}= 14m\Omega@V_{GS}=10V$
- ◆ 30V/15A, $R_{DS(ON)}= 19m\Omega@V_{GS}=4.5V$
- ◆ Super high density cell design for extremely low $R_{DS(ON)}$
- ◆ Exceptional on-resistance and maximum DC current capability
- ◆ TO-252 and TO-251 package design

APPLICATIONS

- Power Management in Note book
- Powered System
- DC/DC Converter
- Load Switch

PIN CONFIGURATION

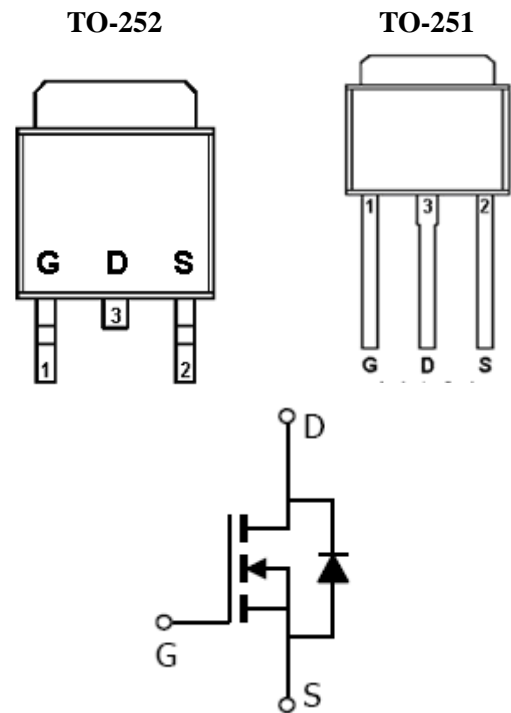

PART MARKING

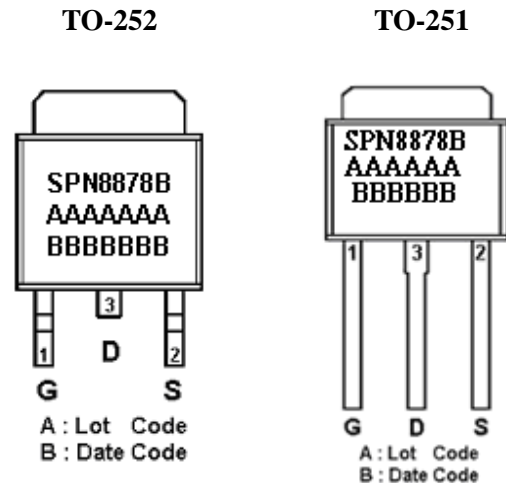



SPN8878B

N-Channel Enhancement Mode MOSFET

PIN DESCRIPTION

Pin	Symbol	Description
1	G	Gate
2	S	Source
3	D	Drain

ORDERING INFORMATION

Part Number	Package	Part Marking
SPN8878BT252RGB	TO-252	SPN8878B
SPN8878BT251TGB	TO-251	SPN8878B

※ SPN8878BT252RGB : Tape Reel ; Pb – Free ; Halogen - Free

※ SPN8878BT251TGB : Tube ; Pb – Free ; Halogen - Free

ABSOLUTE MAXIMUM RATINGS

(TA=25°C Unless otherwise noted)

Parameter	Symbol	Typical	Unit
Drain-Source Voltage	VDSS	30	V
Gate –Source Voltage	VGSS	±20	V
Continuous Drain Current	ID	TA=25°C	18
		TA=100°C	13
Pulsed Drain Current	IDM	40	A
Continuous Drain Current	IS	5	A
Power Dissipation	PD	TA=25°C TO-252-2L	40
		TO-251	55
Avalanche Energy with Single Pulse (Tj=25°C , L = 0.14mH , IAS = 30A , VDD = 20V.)	EAS	63	mJ
Operating Junction Temperature	TJ	-55/150	°C
Storage Temperature Range	TSTG	-55/150	°C
Thermal Resistance-Junction to Ambient	RθJA	100	°C/W



SPN8878B

N-Channel Enhancement Mode MOSFET

ELECTRICAL CHARACTERISTICS

(TA=25°C Unless otherwise noted)

Parameter	Symbol	Conditions	Min.	Typ	Max.	Unit
Static						
Drain-Source Breakdown Voltage	$V_{(BR)DSS}$	$V_{GS}=0V, I_D=250\mu A$	30			V
Gate Threshold Voltage	$V_{GS(th)}$	$V_{DS}=V_{GS}, I_D=250\mu A$	0.6		1.8	
Gate Leakage Current	I_{GSS}	$V_{DS}=0V, V_{GS}=\pm 20V$			± 100	nA
Zero Gate Voltage Drain Current	I_{DSS}	$V_{DS}=24V, V_{GS}=0V$			1	uA
		$V_{DS}=24V, V_{GS}=0V$ $T_J=55^\circ C$			5	
On-State Drain Current	$I_{D(on)}$	$V_{DS}\geq 5V, V_{GS}=10V$	40			A
Drain-Source On-Resistance	$R_{DS(on)}$	$V_{GS}=10V, I_D=20A$		0.012	0.014	Ω
		$V_{GS}=4.5V, I_D=15A$		0.015	0.019	
Forward Transconductance	g_{fs}	$V_{DS}=15V, I_D=20A$	15			S
Diode Forward Voltage	V_{SD}	$I_S=40A, V_{GS}=0V$		0.8	1.5	V
Dynamic						
Total Gate Charge	Q_g	$V_{DS}=15V, V_{GS}=10V$ $I_D=50A$		10	18	nC
Gate-Source Charge	Q_{gs}			2.8		
Gate-Drain Charge	Q_{gd}			2.0		
Input Capacitance	C_{iss}	$V_{DS}=15V, V_{GS}=0V$ $f=1MHz$		850		pF
Output Capacitance	C_{oss}			158		
Reverse Transfer Capacitance	C_{rss}			120		
Turn-On Time	$t_{d(on)}$	$V_{DD}=15V, R_L=0.3\Omega$ $I_D=50A, V_{GEN}=10V$ $R_G=1\Omega$		10	15	nS
	t_r			4	12	
Turn-Off Time	$t_{d(off)}$			15	30	
	t_f			10	15	



SPN8878B

N-Channel Enhancement Mode MOSFET

TYPICAL CHARACTERISTICS

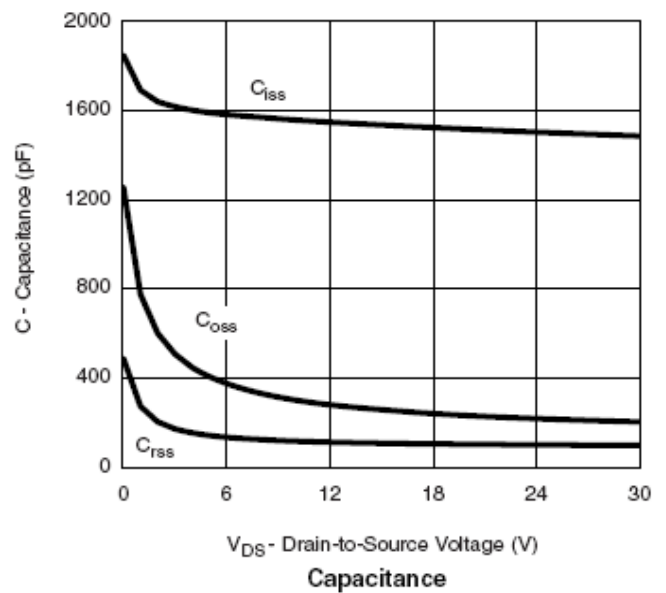
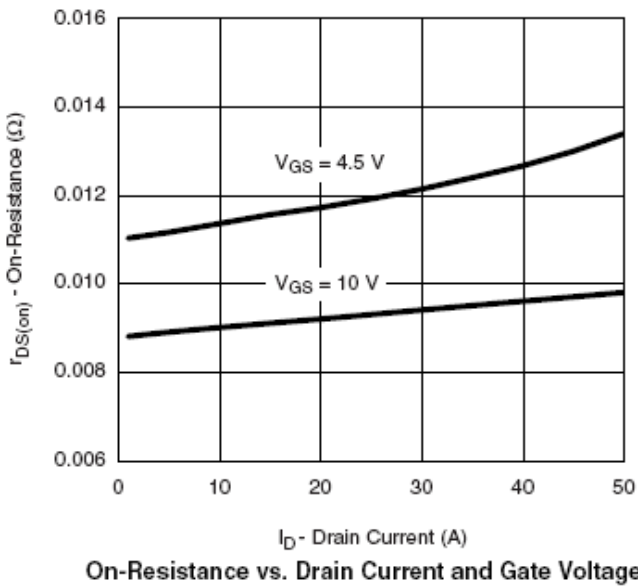
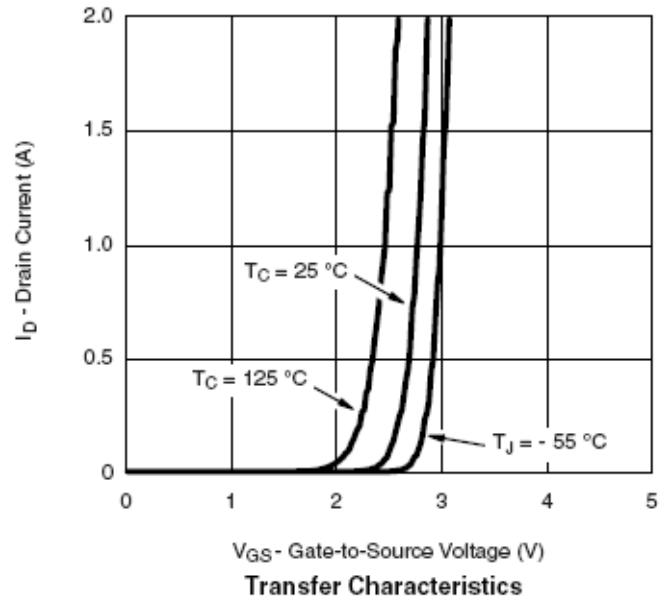
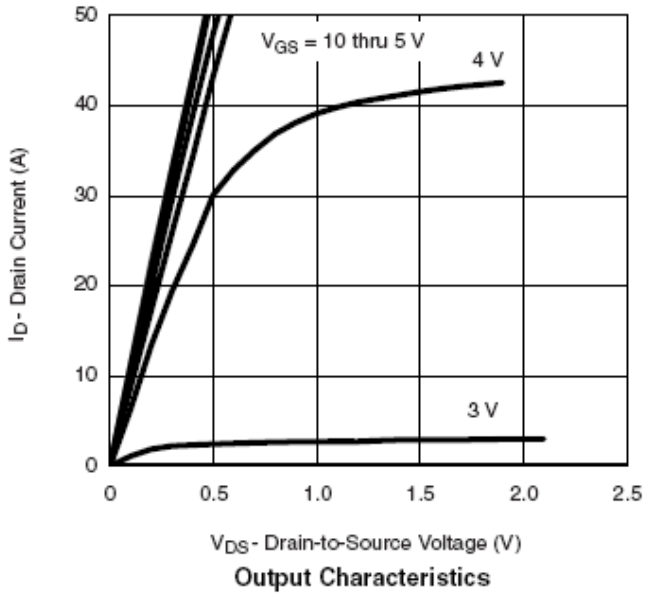



SPN8878B

N-Channel Enhancement Mode MOSFET

TYPICAL CHARACTERISTICS

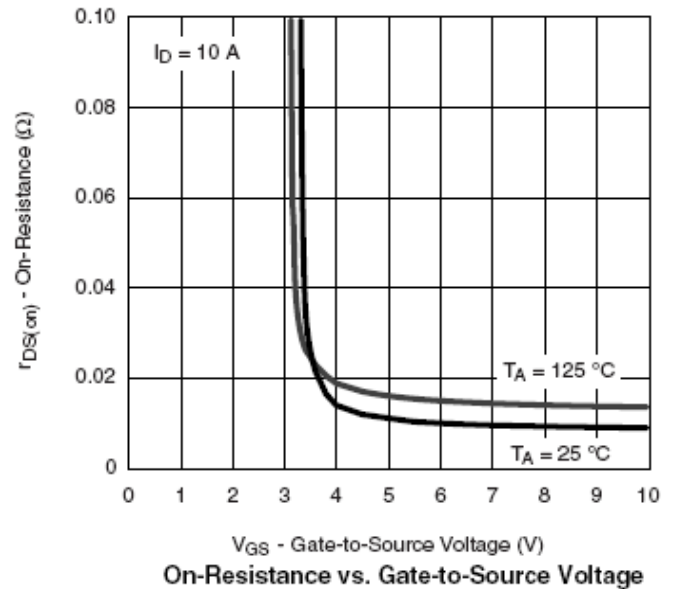
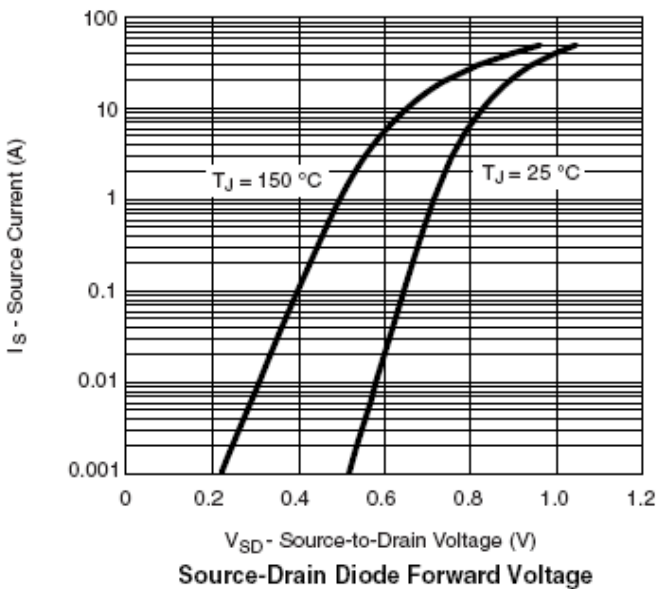
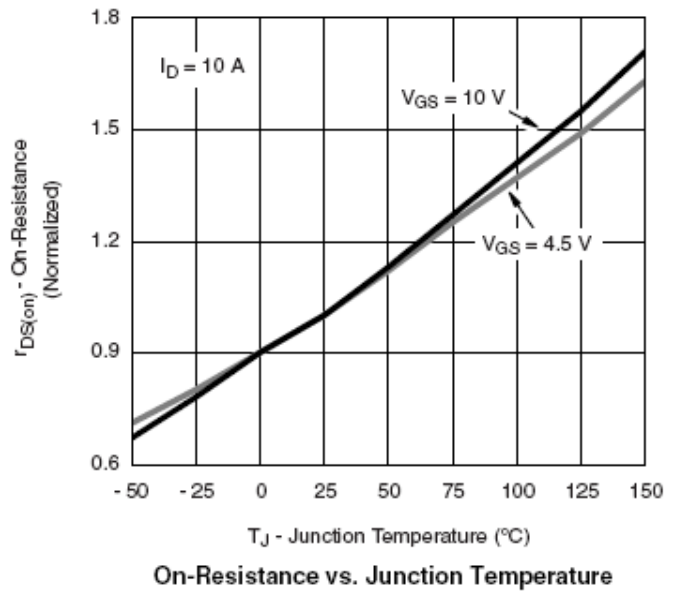
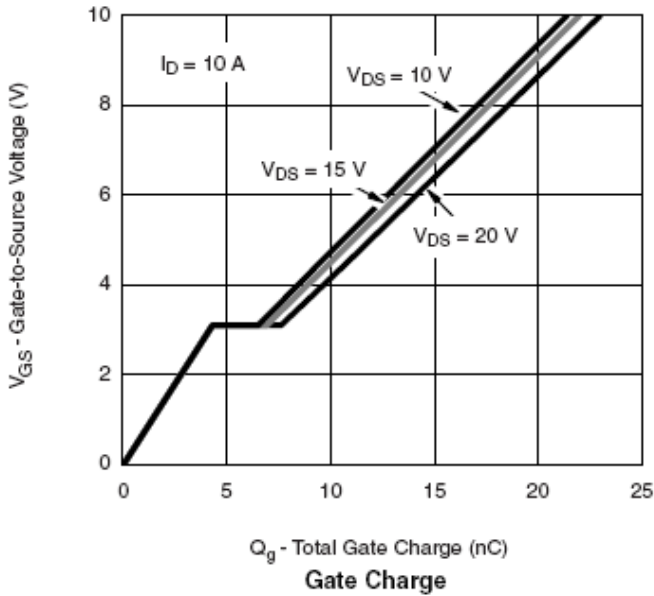



SPN8878B

N-Channel Enhancement Mode MOSFET

TYPICAL CHARACTERISTICS

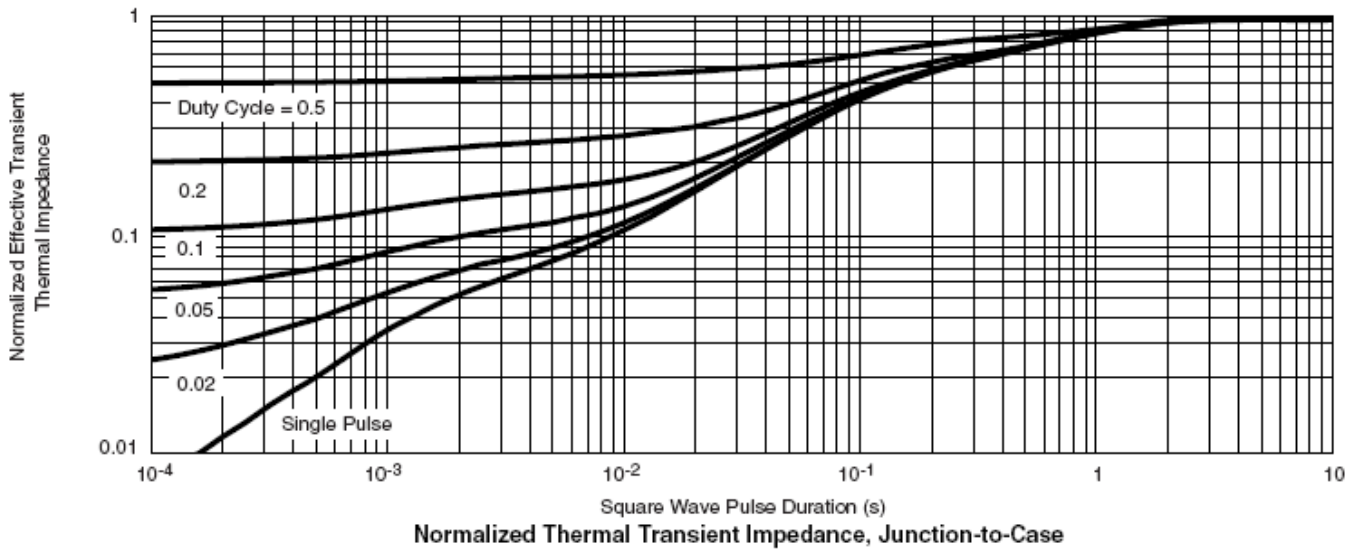
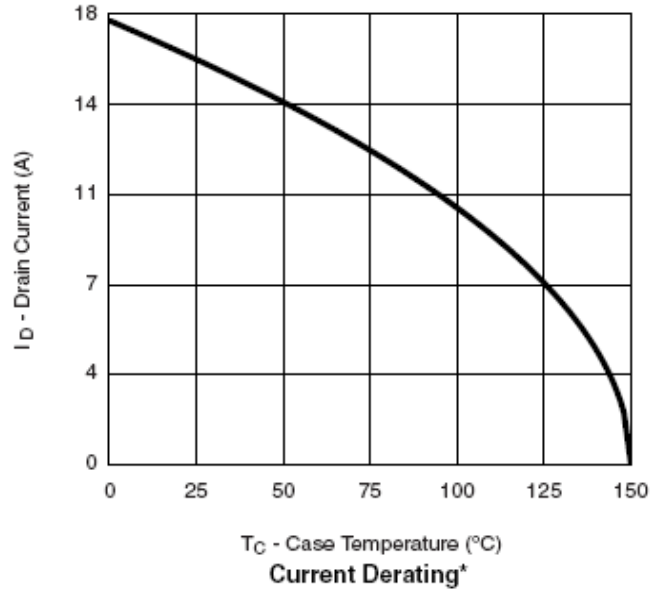
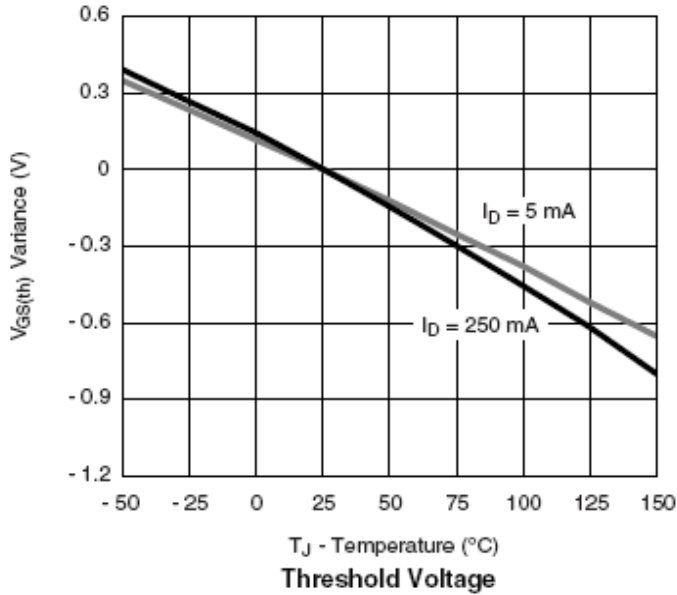



SPN8878B

N-Channel Enhancement Mode MOSFET

TO-252 PACKAGE OUTLINE

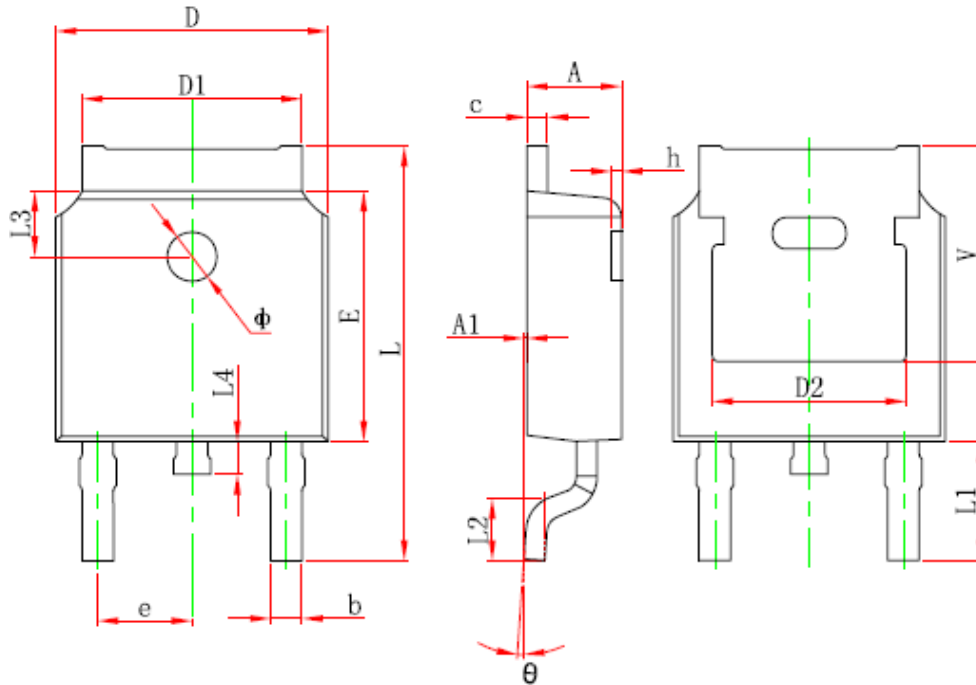

Symbol	Dimensions In Millimeters		Dimensions In Inches	
	Min.	Max.	Min.	Max.
A	2.200	2.400	0.087	0.094
A1	0.000	0.127	0.000	0.005
b	0.660	0.860	0.026	0.034
c	0.460	0.580	0.018	0.023
D	6.500	6.700	0.256	0.264
D1	5.100	5.460	0.201	0.215
D2	4.830 REF.		0.190 REF.	
E	6.000	6.200	0.236	0.244
e	2.186	2.386	0.086	0.094
L	9.800	10.400	0.386	0.409
L1	2.900 REF.		0.114 REF.	
L2	1.400	1.700	0.055	0.067
L3	1.600 REF.		0.063 REF.	
L4	0.600	1.000	0.024	0.039
φ	1.100	1.300	0.043	0.051
θ	0°	8°	0°	8°
h	0.000	0.300	0.000	0.012
V	5.350 REF.		0.211 REF.	



SPN8878B

N-Channel Enhancement Mode MOSFET

TO-251 PACKAGE OUTLINE

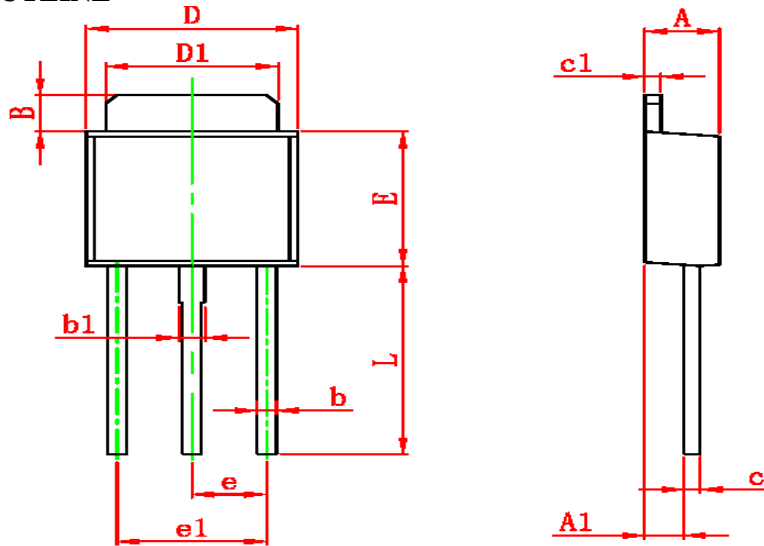

Symbol	Dimensions In Millimeters		Dimensions In Inches	
	Min	Max	Min	Max
A	2.200	2.400	0.087	0.094
A1	1.020	1.270	0.040	0.050
B	1.350	1.650	0.053	0.065
b	0.500	0.700	0.020	0.028
b1	0.700	0.900	0.028	0.035
c	0.430	0.580	0.017	0.023
c1	0.430	0.580	0.017	0.023
D	6.350	6.650	0.250	0.262
D1	5.200	5.400	0.205	0.213
E	5.400	5.700	0.213	0.224
e	2.300 TYP		0.091 TYP	
e1	4.500	4.700	0.177	0.185
L	7.500	7.900	0.295	0.311



SPN8878B

N-Channel Enhancement Mode MOSFET

Information provided is alleged to be exact and consistent. SYNC Power Corporation presumes no responsibility for the penalties of use of such information or for any violation of patents or other rights of third parties which may result from its use. No license is granted by allegation or otherwise under any patent or patent rights of SYNC Power Corporation. Conditions mentioned in this publication are subject to change without notice. This publication surpasses and replaces all information previously supplied. SYNC Power Corporation products are not authorized for use as critical components in life support devices or systems without express written approval of SYNC Power Corporation.

©The SYNC Power logo is a registered trademark of SYNC Power Corporation

©2004 SYNC Power Corporation – Printed in Taiwan – All Rights Reserved

SYNC Power Corporation

7F-2, No.3-1, Park Street

NanKang District (NKSP), Taipei, Taiwan 115

Phone: 886-2-2655-8178

Fax: 886-2-2655-8468

©<http://www.syncpower.com>