



**4D SYSTEMS**

---

# **μCAM**

## **Serial JPEG Camera Module**

### **Data Sheet**

Document Date: 25th January 2010  
Document Revision: 3.0



**4D SYSTEMS**

www.DataSheet4U.com

## **μCAM Serial JPEG Camera Module**

### **Data Sheet**

#### **Description**



The **uCAM** (microCAM) is a highly integrated serial camera module which can be attached to any host system that requires a video camera or a JPEG compressed still camera for embedded imaging applications.

The module uses an OmniVision CMOS VGA colour sensor along with a JPEG compression chip that provides a low cost and low powered camera system. The module has an on-board serial interface (TTL or RS232) that is suitable for a direct connection to any host micro-controller UART or a PC system COM port.

User commands are sent using a simple serial protocol that can instruct the camera to send low resolution (160x120 or 80x60) single frame raw images for a quick viewing or high resolution (640x480 or 320x240) JPEG images for storage or viewing.

The uCAM comes in a compact form factor with a built in lens and a 4-wire connector that provides easy access to both power and serial data.

#### **Features**

- Small size, low cost and low powered camera module for embedded imaging applications.
  - uCAM-TTL: 3.3V DC Supply
  - uCAM-232: 5.0V DC Supply
- On-board EEPROM provides a command-based interface to external host via TTL or RS-232 serial link .
- UART: up to 1.2Mbps for transferring JPEG still pictures or raw images.
- On board OmniVision OV7640/8 VGA colour sensor and JPEG CODEC for different resolutions.
- Built-in down sampling, clamping and windowing circuits for VGA, QVGA, 160x120 or 80x60 image resolutions.
- Built-in colour conversion circuits for 2-bit gray, 4-bit gray, 8-bit gray, 12-bit RGB, 16-bit RGB or standard JPEG preview images.
- No external DRAM required.

#### **Applications**

- General purpose embedded imaging and control
- Security systems, Access Control systems, Elevator and Remote monitoring.
- Robotics vision, object detection and recognition.
- Industrial control, automotive and medical systems.
- Smart home, video intercoms.

**Table of Contents**

**1. Pin Configuration and Summary.....5**

**2. Pin Description.....6**

    VCC pin 2 (uCAM Supply Voltage Input):.....6

    GND pin 3 (uCAM Ground):.....6

    TX pin 4 (Serial Transmit):.....6

    RX pin 5 (Serial Receive):.....6

**3. Serial Interface - UART.....6**

    3.1 Single Byte Timing.....6

    3.2 Command Sequence Timing.....6

    3.3 Auto-Baud Detect.....7

    3.4 Setting the Baud Rates.....7

**4. Command Set.....8**

    4.1 INITIAL (AA01h).....8

        4.1.1 Colour Type.....8

        4.1.2 RAW Resolution.....9

        4.1.3 JPEG Resolution.....9

    4.2 GET PICTURE (AA04h).....9

        4.2.1 Picture Type.....9

    4.3 SNAPSHOT (AA05h).....9

        4.3.1 Snapshot Type.....9

        4.3.2 Skip Frame Counter.....9

    4.4 SET PACKAGE SIZE (AA06h).....10

        4.4.1 Package Size.....10

    4.5 SET BAUD RATE (AA07h).....10

        4.5.1 Baud Rates.....10

    4.6 RESET (AA08h).....11

        4.6.1 Reset Type.....11

    4.7 DATA (AA0Ah).....11

        4.8.1 Data Type.....11

        4.8.2 Length.....11

    4.8 SYNC (AA0Dh).....11

    4.9 ACK (AA0Eh).....11

        4.10.1 Command ID.....11

        4.10.2 ACK Counter.....11

        4.10.3 Package ID.....11

    4.10 NAK (AA0Fh).....12

        4.11.1 NAK Counter.....12

        4.11.2 Error Number.....12

    4.11 LIGHT (AA13h).....12

        4.12.1 Light Frequency Type.....12

**5. Command Protocol.....13**

---

---

5.1 SYNC Command.....	13
5.2 Connecting to the uCAM.....	14
5.3 INITIAL, GET PICTURE, SNAPSHOT, SET PACKAGE SIZE, RESET Commands.....	15
5.4 Taking SNAPSHOT Pictures.....	16
5.4.1 Example: JPEG Snapshot Picture (640 x 480 resolution).....	16
5.4.2 Example: Snapshot Picture (160 x 120 resolution, 16bit colour, uncompressed/RAW picture).....	17
5.5 JPEG Preview Pictures (Video).....	18
5.5.1 Example: JPEG Preview Picture (320 x 240 resolution).....	18
5.5.2 Example: Preview Picture (80 x 60 resolution, 12bit colour, uncompressed/RAW preview picture).....	19
<b>6. Development and Support Tools.....</b>	<b>20</b>
6.1 microUSB – USB to Serial Bridge.....	20
6.2 Embedded Display Modules.....	20
6.3 Demo PC Software Tool.....	21
<b>7. Specifications and Ratings.....</b>	<b>22</b>
<b>Proprietary Information.....</b>	<b>23</b>
<b>Disclaimer of Warranties &amp; Limitation of Liability.....</b>	<b>23</b>
<b>Contact Information.....</b>	<b>23</b>

**1. Pin Configuration and Summary**

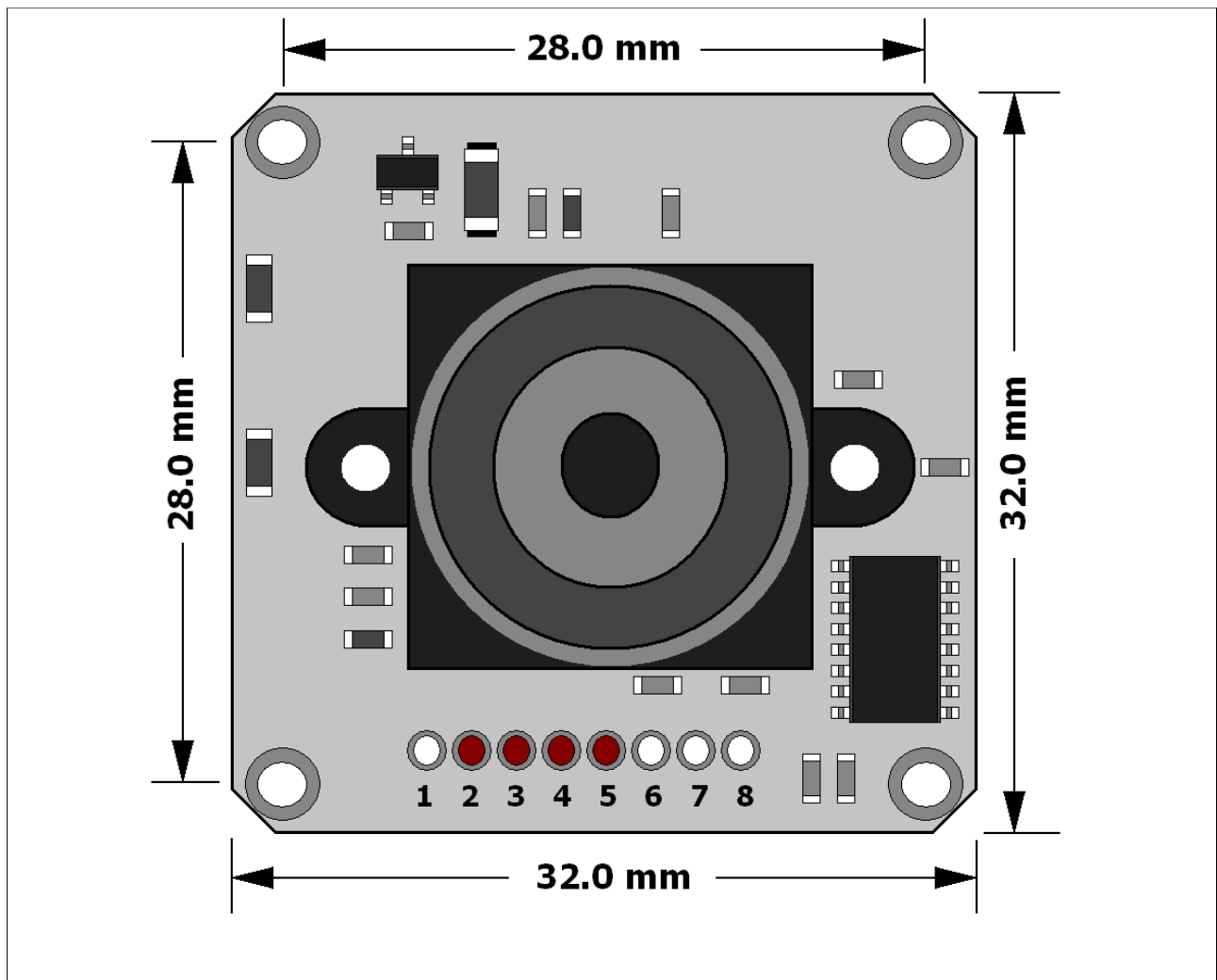

Pin	Symbol	I/O	Description
2	VCC	P	Main Voltage Supply +ve input pin. <b>uCAM-TTL</b> : 3.0V to 3.6V DC range nominal 3.3V. <b>UCAM-232</b> : 4.5V to 5.5V DC range, nominal 5.0V.
3	GND	P	Supply Ground.
4	TX	O	Asynchronous Serial Transmit pin. Connect this pin to host controller Serial Receive (Rx) signal. The host receives data from uCAM via this pin.
5	RX	I	Asynchronous Serial Receive pin. Connect this pin to host controller Serial Transmit (Tx) signal. The host transmits commands to the uCAM via this pin.
1, 6, 7, 8	NC	--	No Connect.

## 2. Pin Description

### VCC pin 2 (uCAM Supply Voltage Input):

Module supply voltage input pin. This pin must be connected to a regulated supply voltage.  
 uCAM-TTL : 3.0V to 3.6V DC range, nominal 3.3V.  
 uCAM-232 : 4.5V to 5.5V DC range, nominal 5.0V.

### GND pin 3 (uCAM Ground):

Module ground pin. This pin must be connected to ground.

### TX pin 4 (Serial Transmit):

Asynchronous Serial port Transmit pin, TX. Connect this pin to host Serial Receive (Rx) signal. The host receives data from the uCAM module via this pin.

### RX pin 5 (Serial Receive):

Asynchronous Serial port Receive pin, RX. Connect this pin to host Serial Transmit (Tx) signal. The host transmits data to the uCAM via this pin.

## 3. Serial Interface - UART

The uCAM has a dedicated hardware UART that can communicate with a host via this serial port. This is the main interface used by the host to communicate with the module to send commands and receive back data. The primary features are:

- Full-Duplex 8 bit data transmission and reception through the TX and RX pins.
- Data format: 8 bits, No Parity, 1 Stop bit.
- Auto detect Baud rates from 14400 baud up to 115200 baud.
- Selectable Baud rates up to 1228800 bps.

The uCAM is available in 2 models that offer different versions of its serial interface. The **uCAM-TTL** has low voltage serial TTL levels which can be directly interfaced to a micro-controller and the **uCAM-232** has a RS-232 voltage transceiver that can be interfaced to any host system COM port such as a PC.

### 3.1 Single Byte Timing

A single byte serial transmission consists of the start bit, 8-bits of data followed by the stop bit. The start bit is always 0, while a stop bit is always 1. The LSB (Least Significant Bit, Bit 0) is sent out first following the start bit. Figure 3.1 shows a single byte transmission timing diagram.

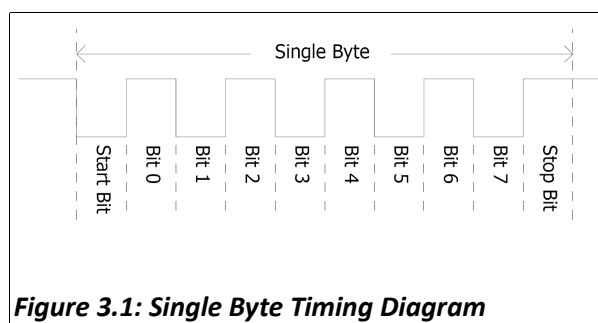
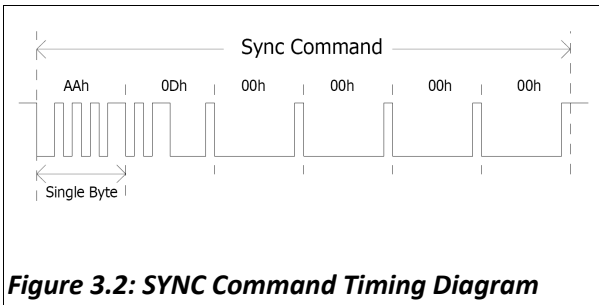

Figure 3.1: Single Byte Timing Diagram

### 3.2 Command Sequence Timing

A single command consists of 6 continuous single byte serial transmissions. The following Figure 3.2 shows an example of the SYNC (AA0D00000000h) command.



### 3.3 Auto-Baud Detect

The module can auto-detect the baud rate of the incoming command. The host should make connection with one of the following baud rates:

- 14400 bps
- 56000 bps
- 57600 bps
- 115200 bps

The module will keep using the last baud rate until the next power cycle.

### 3.4 Setting the Baud Rates

You can set Baud rates using the Set Baud command.

$$\text{Baud rate} = 14.7456\text{MHz} / 2 \times (2^{\text{nd}} \text{ Divider} + 1) / 2 \times (1^{\text{st}} \text{ Divider} + 1)$$

The maximum Baud rate you can get is 1228800, which is achieved by following two combinations,

- 1<sup>st</sup> Divider = 0
- 2<sup>nd</sup> Divider = 2
- Or
- 1<sup>st</sup> Divider = 2
- 2<sup>nd</sup> Divider = 0

Note: Baud rate changes holds until “full reset” command is sent or Power cycle occurs. So, you can synchronise at last used Baud rate or any of the Auto-detect Baud rate.

## 4. Command Set

The uCAM module supports a total of 10 commands:

Command	ID Number	Parameter1	Parameter2	Parameter3	Parameter4
INITIAL	AA01h	00h	Colour Type	RAW Resolution (Still Image only)	JPEG Resolution
GET PICTURE	AA04h	Picture Type	00h	00h	00h
SNAPSHOT	AA05h	Snapshot Type	Skip Frame (Low Byte)	Skip Frame (High Byte)	00h
SET PACKAGE SIZE	AA06h	08h	Package Size (Low Byte)	Package Size (High Byte)	00h
Set Baud Rate	AA07h	1 <sup>st</sup> Divider	2 <sup>nd</sup> Divider	00h	00h
RESET	AA08h	Reset Type	00h	00h	XXh*
DATA	AA0Ah	Data Type	Length Byte 0	Length Byte 1	Length Byte 2
SYNC	AA0Dh	00h	00h	00h	00h
ACK	AA0Eh	Command ID	ACK Counter	00h / Package ID Byte 0	00h / Package ID Byte 1
NAK	AA0Fh	00h	NAK Counter	Error Number	00h
LIGHT	AA13h	Frequency Type	00h	00h	00h

\*If the parameter is 0xFF, the command is a special Reset command and the module responds to it immediately.

### 4.1 INITIAL (AA01h)

The host issues this command to configure the preview image size and colour type. After receiving this command, the module will send out an ACK command to the host if the configuration was successful. Otherwise, a NAK command will be sent out.

#### 4.1.1 Colour Type

The uCAM can support 7 different colour types as follow:

2-bit Gray Scale (RAW, 2-bit for Y only)	01h
4-bit Gray Scale (RAW, 4-bit for Y only)	02h
8-bit Gray Scale (RAW, 8-bit for Y only)	03h
8-bit Colour (RAW, 332(RGB))	04h
12-bit Colour (RAW, 444(RGB))	05h
16-bit Colour (RAW, 565(RGB))	06h
JPEG	07h



**4.1.2 RAW Resolution**

80 x 60	01h
160 x 120	03h
320 x 240	05h
640 x 480	07h
128 x 128	09h
128 x 96	0Bh

**4.1.3 JPEG Resolution**

The uCAM embedded JPEG Code can support only multiples of 16 pixels, therefore the JPEG preview mode can only support following image sizes. It is different from the RAW preview mode.

80 x 64	01h
160 x 128	03h
320 x 240	05h
640 x 480	07h

**4.2 GET PICTURE (AA04h)**

The host issues this command to request a picture from the uCAM.

**4.2.1 Picture Type**

Snapshot Picture	01h
Preview (RAW) Picture	02h
JPEG Picture	05h

**4.3 SNAPSHOT (AA05h)**

The uCAM will hold a single frame of still picture data in its buffer after receiving this command.

**4.3.1 Snapshot Type**

Compressed Picture (JPEG)	00h
Uncompressed Picture (RAW)	01h

**4.3.2 Skip Frame Counter**

The number of dropped frames can be defined before capture occurs. "0" keeps the current frame, "1" captures the next frame, and so on.

#### 4.4 SET PACKAGE SIZE (AA06h)

The host issues this command to change the size of the data package which is used to transmit the compressed JPEG image data from the uCAM to the host. This command should be issued before sending SNAPSHOT or GET PICTURE commands to the uCAM.

**Note:** The size of the last package varies for different JPEG image sizes.

##### 4.4.1 Package Size

The default size is 64 bytes and the maximum size is 512 bytes.



- **ID** : Package ID, starts from zero for an image
- **Data Size** : Size of image data in the package
- **Verify Code** : Error detection code, equals to the lower byte of sum of the whole package data except the verify code field. The higher byte of this code is always zero. i.e. verify code = lowbyte(sum(byte[0] to byte[N-2]))

##### Note1:

Once the host receives the image size from the uCAM, the following simple equation can be used to calculate the number of packages that will be received according to the package size set. The package settings only apply for compressed JPEG images.

$$\text{Number of packages} = \text{Image size} / (\text{Package size} - 6)$$

##### Note2:

As the transmission of an uncompressed (RAW) image does not require the package mode, it is not necessary to set the package size for an uncompressed image. All of the pixel data for the RAW image will be sent continuously until completion.

##### Note3:

Package size must not be odd or multiple of 16

#### 4.5 SET BAUD RATE (AA07h)

The host can set the Baud rates using this command. There could be several different combinations the two divisors can be set to achieve a particular baud rate. Say, to achieve 921600 you can set

1st divider 01h, 2nd divider 01h OR 1st divider 00h, 2nd divider 03h OR 1st divider 03h, 2nd divider 00h

##### 4.5.1 Baud Rates

Baud Rate (bps)	7200	9600	14400	.....	737280	921600	1228800
1 <sup>st</sup> Divider(Hex)	FFh	BFh	7Fh	.....	00h	03h	02h
2 <sup>nd</sup> Divider(Hex)	01h	01h	01h	.....	04h	00h	00h

## 4.6 RESET (AA08h)

The host can reset the uCAM by issuing this command.

### 4.6.1 Reset Type

- 00h Resets the whole system. The uCAM will reboot and reset all registers and state machines.
- 01h Resets the state machines only.

## 4.7 DATA (AA0Ah)

The uCAM issues this command to inform the host the type and the size of the image data which is ready for transmitting to the host.

### 4.8.1 Data Type

Snapshot Picture	01h
Preview (RAW) Picture	02h
JPEG Preview Picture	05h

### 4.8.2 Length

These three bytes represent the length of data of the Picture that is ready for transmission back to the host.

## 4.8 SYNC (AA0Dh)

Either the host or the uCAM module can issue this command to make a connection. The ACK command must be sent out after receiving this command. Refer to Section 5.2 for more details.

## 4.9 ACK (AA0Eh)

This command indicates the success of the last operation. After receiving any valid command, the ACK command must be sent out except when getting preview data. The host can issue this command to request image data package with the desired package ID after receiving the DATA command from the uCAM. The host should send this command with package ID F0F0h after receiving a package to end the package transfer.

**Note:** the field “command ID” should be 00h when request is for image data package.

### 4.10.1 Command ID

The command with that ID is acknowledged by this command.

### 4.10.2 ACK Counter

For debug only.

### 4.10.3 Package ID

For acknowledging the DATA command, these two bytes represent the requested package ID. For acknowledging other commands, these two bytes are set to 00h.

**4.10 NAK (AA0Fh)**

This command indicates corrupted transmission or unsupported features.

**4.11.1 NAK Counter**

For debug only.

**4.11.2 Error Number**

Picture Type Error	01h	Parameter Error	0Bh
Picture Up Scale	02h	Send Register Timeout	0Ch
Picture Scale Error	03h	Command ID Error	0Dh
Unexpected Reply	04h	Picture Not Ready	0Fh
Send Picture Timeout	05h	Transfer Package Number Error	10h
Unexpected Command	06h	Set Transfer Package Size Wrong	11h
SRAM JPEG Type Error	07h	Command Header Error	F0h
SRAM JPEG Size Error	08h	Command Length Error	F1h
Picture Format Error	09h	Send Picture Error	F5h
Picture Size Error	0Ah	Send Command Error	FFh

**4.11 LIGHT (AA13h)**

The host issues this command to change the light frequency (hum) response of the uCAM.

**4.12.1 Light Frequency Type**

50Hz	00h
60Hz	01h

## 5. Command Protocol

This section outlines command usage and protocol transaction between the host and the uCAM module.

### 5.1 SYNC Command

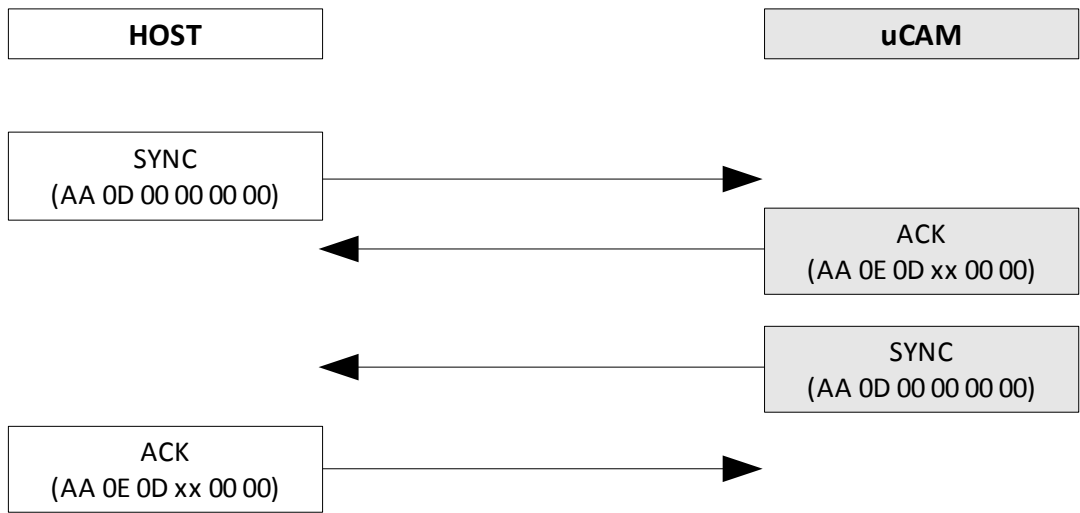

### 5.2 Connecting to the uCAM

Send the SYNC command until receiving the ACK command from uCAM (usually an ACK command is received after sending the SYNC command 25 times). This must be performed following a power-up.

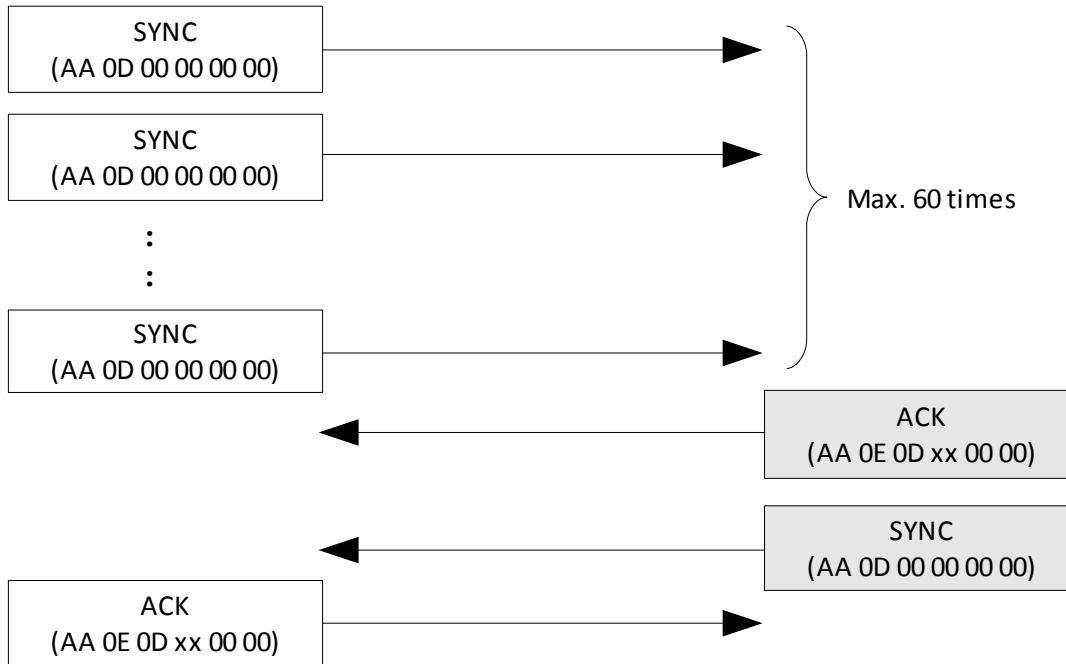

**Note1:**  
The host should send the SYNC command one by one continuously until receiving the ACK and SYNC commands back from the uCAM module. Sometimes up to 25 to 60 SYNC commands maybe required before the module will respond. After receiving the response, the host should reply with the ACK command to finalise the synchronisation process.

**Note2:**  
After synchronising and establishing a communications link with the uCAM, allow up to 1-2 seconds before capturing the first image. The uCAM needs this time to allow its AGC and AEC circuits to stabilise, otherwise the received image luminance maybe too high or too low.

**5.3 INITIAL, GET PICTURE, SNAPSHOT, SET PACKAGE SIZE, RESET Commands**

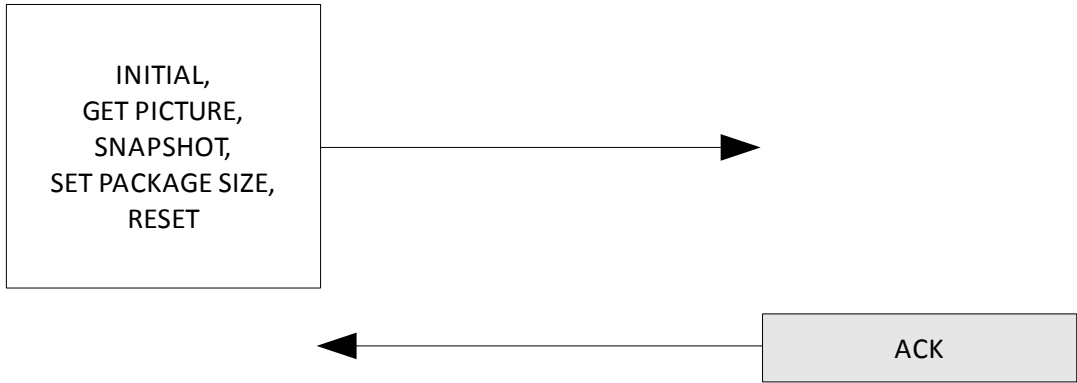

### 5.4 Taking SNAPSHOT Pictures

Make sure a connection is established first (Section 5.2 Connecting to the uCAM) before using the following communications.

#### 5.4.1 Example: JPEG Snapshot Picture (640 x 480 resolution)

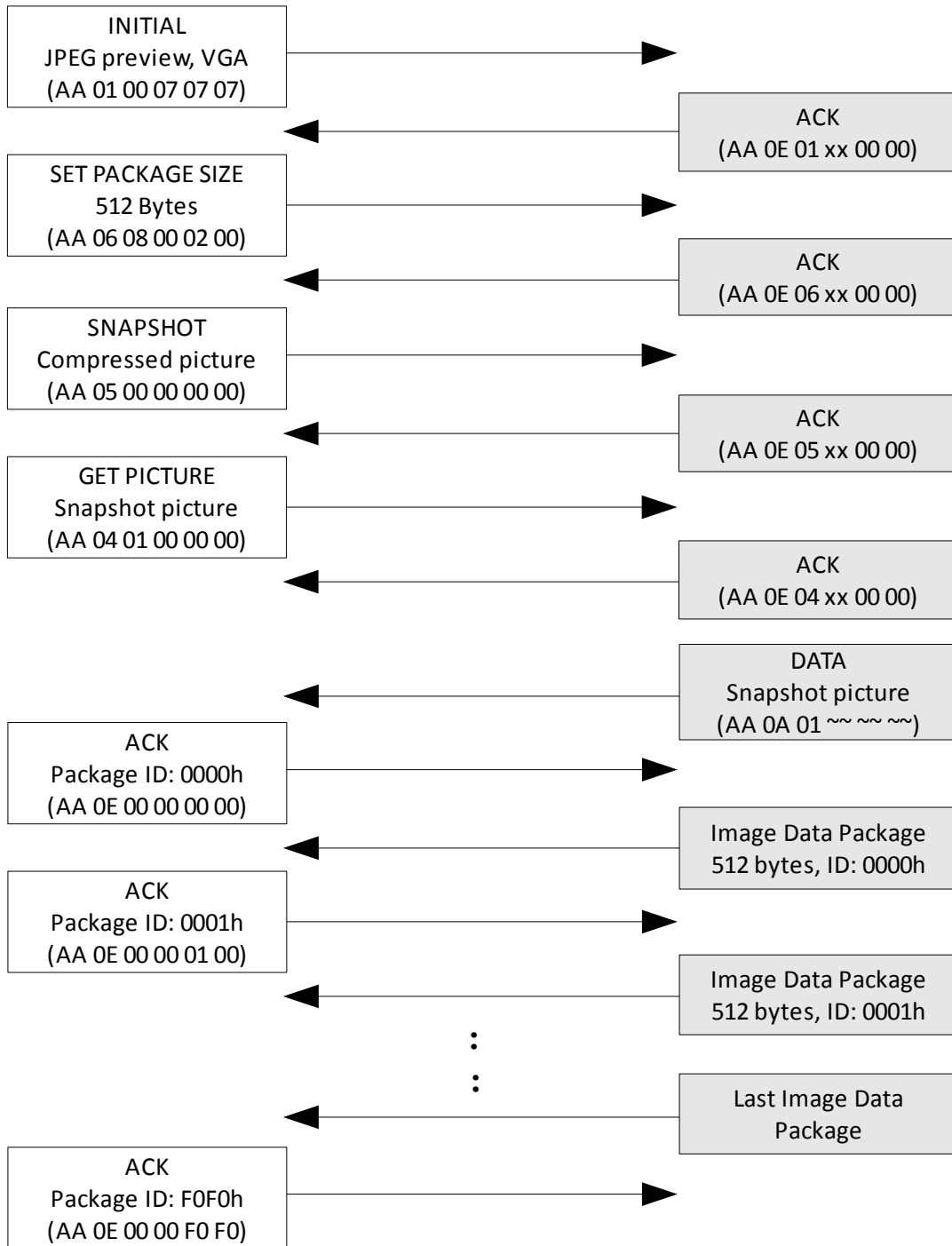

**Note:**

xx : Don't care      ~ ~ : Image size returned by uCAM



5.4.2 Example: Snapshot Picture (160 x 120 resolution, 16bit colour, uncompressed/RAW picture)

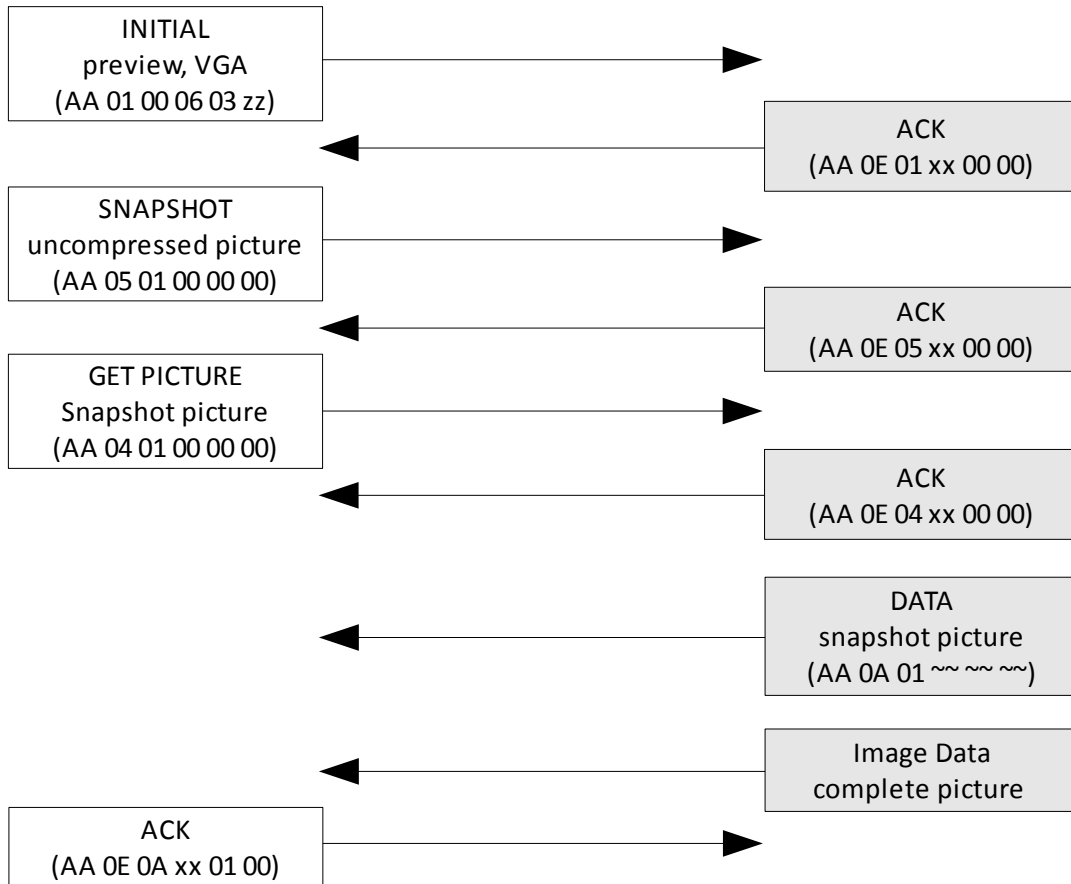

**Note:**

- xx : Don't care
- zz : 01, 03, 05 or 07. Don't care in RAW mode
- ~~ : Image size returned by uCAM

### 5.5 JPEG Preview Pictures (Video)

Make sure a connection is established first (Section 5.2 Connecting to the uCAM) before using the following communications.

#### 5.5.1 Example: JPEG Preview Picture (320 x 240 resolution)

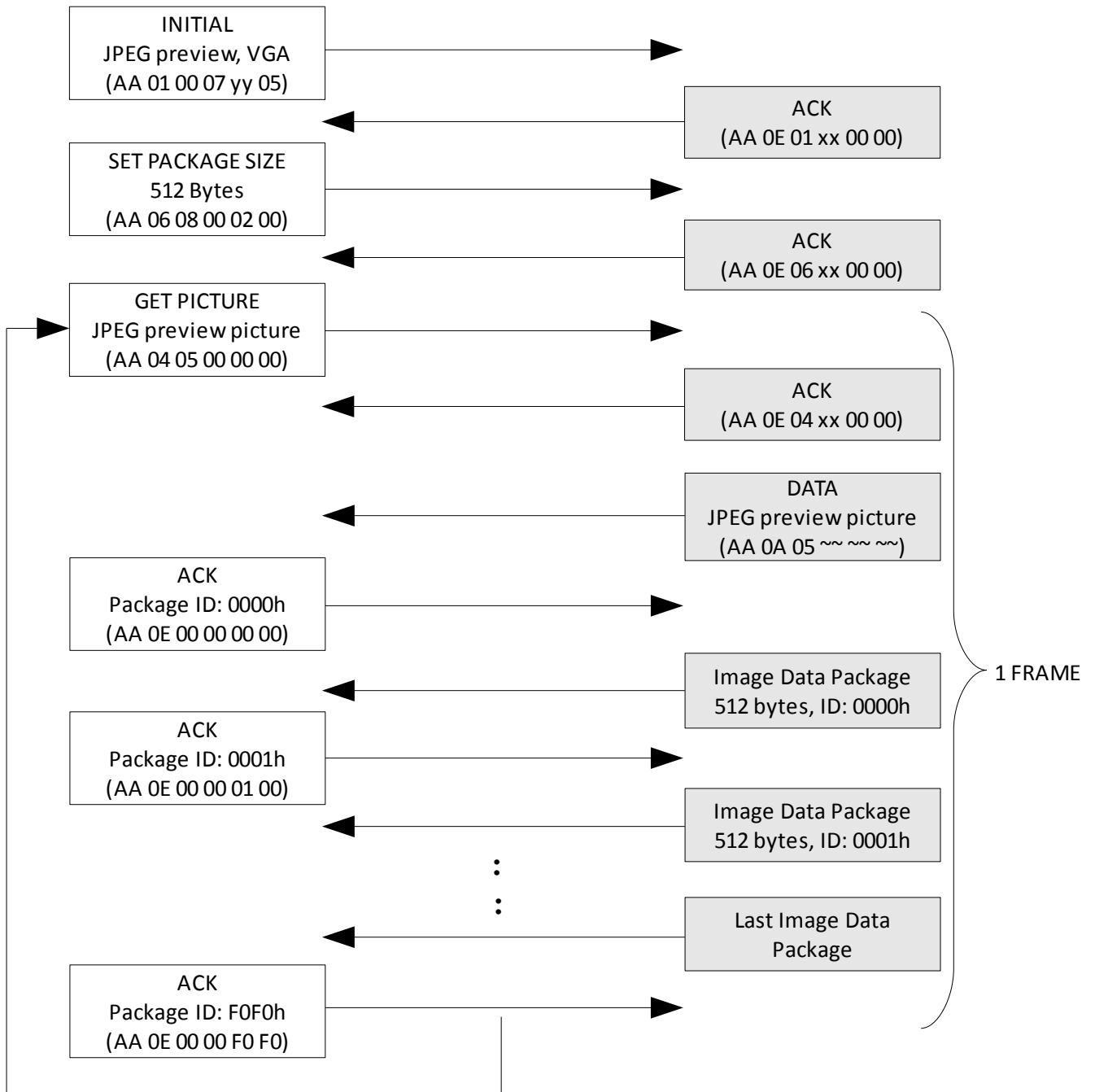

**Note:**

- xx : Don't care
- yy : 01 or 03. Don't care in JPEG mode
- ~ ~ : Image size returned by uCAM

5.5.2 Example: Preview Picture (80 x 60 resolution, 12bit colour, uncompressed/RAW preview picture)

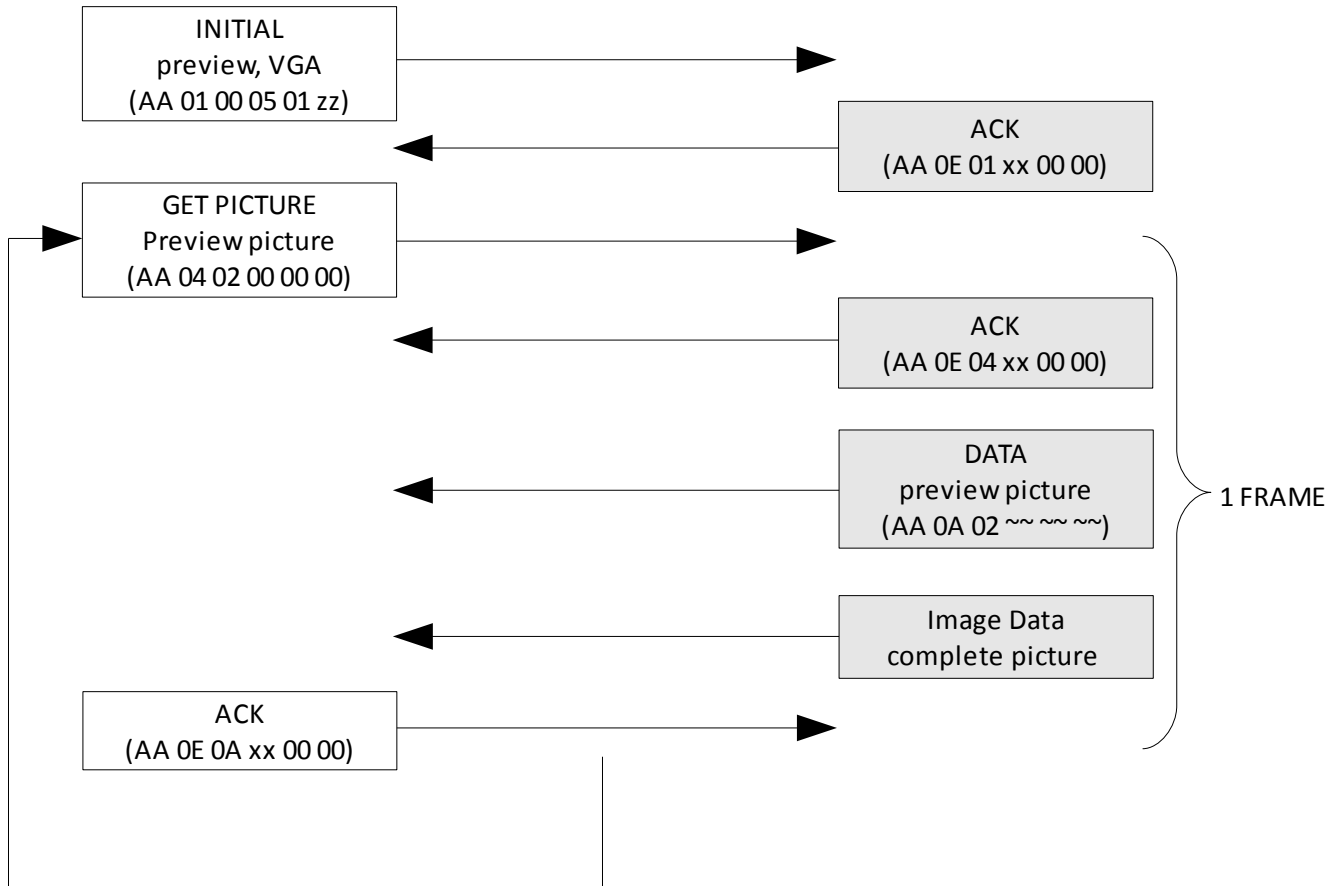

**Note:**

- xx : Don't care
- zz : 01, 03, 05 or 07. Don't care in RAW mode
- ~~ : Image size returned by uCAM

## 6. Development and Support Tools

### 6.1 microUSB – USB to Serial Bridge

The micro-USB module is a USB to Serial bridge adaptor that provides a convenient physical link between the PC and any embedded serial device. A range of custom made micro-USB devices such as the uUSB-MB5 and the uUSB-CE5 are available from 4D Systems (must be purchased separately). The micro-USB module provides power and a serial interface (TTL levels) directly to the uCAM-TTL module that can be used with the demo software.

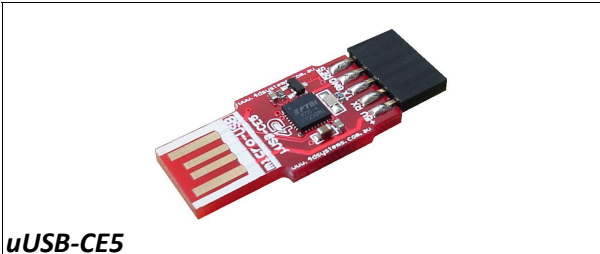

**uUSB-CE5**

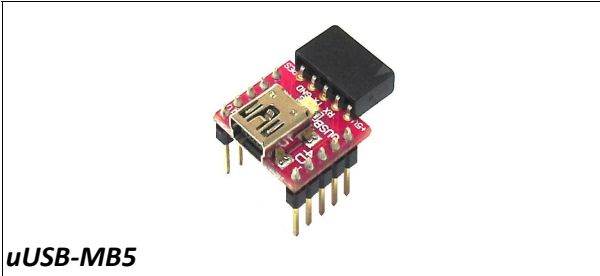

**uUSB-MB5**

### 6.2 Embedded Display Modules

The following display modules, available from 4D Systems, are ideal for many embedded applications with the uCAM-TTL camera.

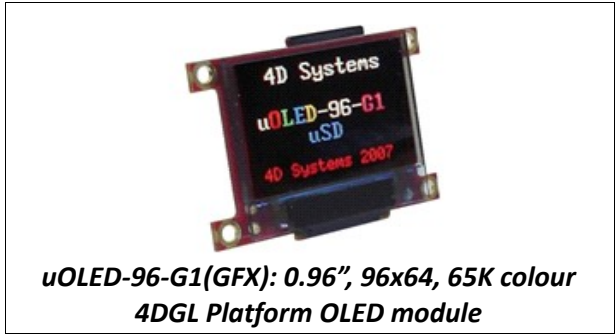

**uOLED-96-G1(GFX): 0.96", 96x64, 65K colour  
4DGL Platform OLED module**

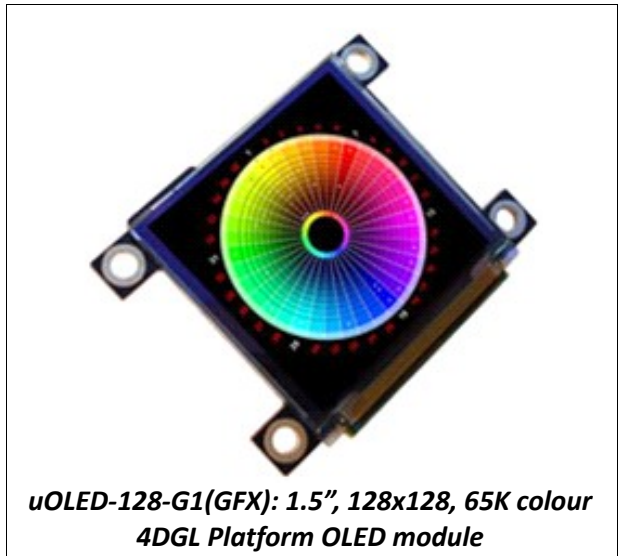

**uOLED-128-G1(GFX): 1.5", 128x128, 65K colour  
4DGL Platform OLED module**



**uOLED-160-G1(GFX): 1.7", 160x128, 65K colour  
4DGL Platform OLED module**



**uOLED-32028-P1(T): 2.8", 240x320, 65K colour 4DGL Platform AMOLED module**



**uLCD-32032-P1T: 3.2", 240x320, 65K colour 4DGL Platform TFT module**

### 6.3 Demo PC Software Tool

Demo software is available for Windows based PC systems to test the uCAM.

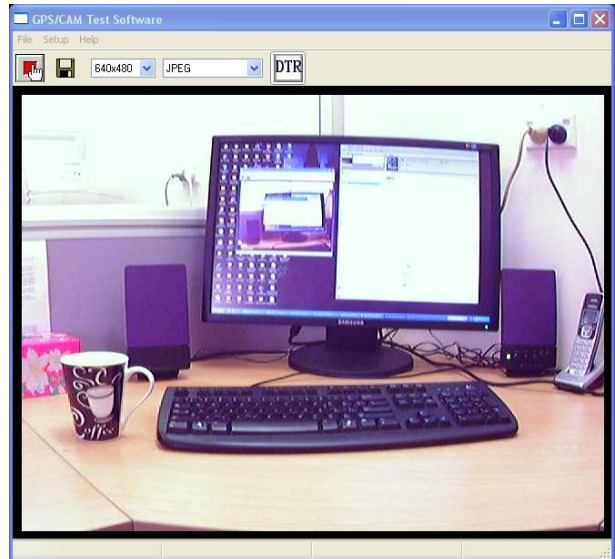

Following diagrams show how to connect the uCAM-TTL and uCAM-232 to a PC to use with the test software.

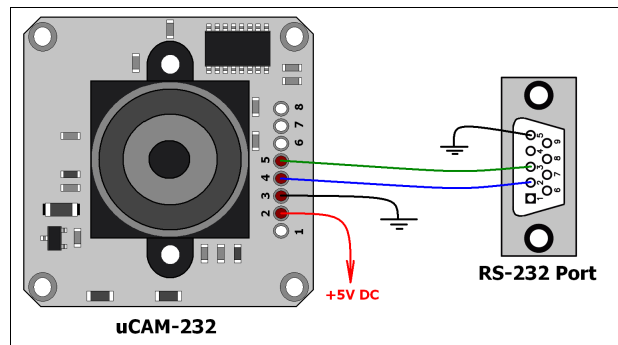
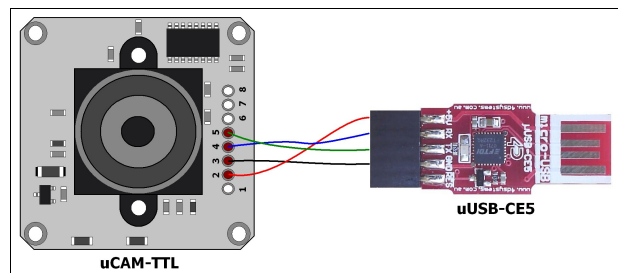

## 7. Specifications and Ratings

Recommended Operating Conditions					
Parameter	Conditions	Min	Typ	Max	Units
<b>uCAM-232</b>					
Supply Voltage (VCC)		4.5	5.0	5.5	V
Input Voltage Range	RX pin	-25	--	25	V
<b>uCAM-TTL</b>					
Supply Voltage (VCC)		3.0	3.3	3.6	V
Input Voltage Range	RX pin	GND	--	VCC	V
<b>uCAM-232, uCAM-TTL</b>					
Operational Delay	After Synchronising	1000	2000	--	ms
Operating Ambient Temperature		-15		+70	°C
Storage Temperature	RH 95% max.	-40		+85	°C

Global Characteristics based on Operating Conditions					
Parameter	Conditions	Min	Typ	Max	Units
<b>uCAM-232</b>					
Supply Current (ICC)	VCC = 5.0V	60	64	80	mA
Output Voltage Range	TX pin	-5.0	--	5.0	V
<b>uCAM-TTL</b>					
Supply Current (ICC)	VCC = 3.3V	58	62	76	mA
Output Voltage Range	TX pin	GND	--	2.4	V

Optical Characteristics	
Item	Parameter
Image Sensor	1/4" OmniVision CMOS, 300K pixels
Pixel Size	5.6µm x 5.6µm
SNR	45dB
Dynamic Range	60dB
White Balance	Automatic
Exposure	Automatic, self regulating, 1/50(1/60) – 1/100,000(sec)
Lens viewing angle(2 options)	90 degrees, 120 degrees

Ordering Information
<p><b>Order Code:</b>                      uCAM-TTL-90 (with 90 degree angle lens)                      uCAM-TTL-120 (with 120 degree angle lens)                      uCAM-232-90 (with 90 degree angle lens)                      uCAM-232-120 (with 120 degree angle lens)</p> <p><b>Package:</b> 150mm x 95mm (ZIF Bag dimensions).</p>

## Proprietary Information

The information contained in this document is the property of 4D Systems Pty. Ltd. and may be the subject of patents pending or granted, and must not be copied or disclosed without prior written permission.

4D Systems endeavours to ensure that the information in this document is correct and fairly stated but does not accept liability for any error or omission. The development of 4D Systems products and services is continuous and published information may not be up to date. It is important to check the current position with 4D Systems.

All trademarks belong to their respective owners and are recognised and acknowledged.

## Disclaimer of Warranties & Limitation of Liability

4D Systems makes no warranty, either express or implied with respect to any product, and specifically disclaims all other warranties, including, without limitation, warranties for merchantability, non-infringement and fitness for any particular purpose.

Information contained in this publication regarding device applications and the like is provided only for your convenience and may be superseded by updates. It is your responsibility to ensure that your application meets with your specifications.

In no event shall 4D Systems be liable to the buyer or to any third party for any indirect, incidental, special, consequential, punitive or exemplary damages (including without limitation lost profits, lost savings, or loss of business opportunity) arising out of or relating to any product or service provided or to be provided by 4D Systems, or the use or inability to use the same, even if 4D Systems has been advised of the possibility of such damages.

Use of 4D Systems' devices in life support and/or safety applications is entirely at the buyer's risk, and the buyer agrees to defend, indemnify and hold harmless 4D Systems from any and all damages, claims, suits, or expenses resulting from such use. No licenses are conveyed, implicitly or otherwise, under any 4D Systems intellectual property rights.

## Contact Information

For Technical Support : [support@4dsystems.com.au](mailto:support@4dsystems.com.au)

For Sales Support : [sales@4dsystems.com.au](mailto:sales@4dsystems.com.au)

Website : [www.4dsystems.com.au](http://www.4dsystems.com.au)

**Copyright 4D Systems Pty. Ltd. 2000-2009.**