

GENERAL DESCRIPTION

The 0912-45 is an internally matched, common base transistor providing 45 watts of pulsed RF output power across the 960-1215 MHz band. This transistor is specifically designed for avionics pulsed radar applications.

0912-45
45 WATTS - 50 VOLTS
960-1215 MHz

AVIONICS PULSED BIPOLAR

ABSOLUTE MAXIMUM RATINGS

Maximum Power Dissipation @ 25 C Case Temperature	225 W
Maximum Voltage and Current	
BVces Collector to Emitter Voltage	60 V
BVebo Emitter to Base Voltage	4.0 V
ic Collector Current	4.5 A

Maximum Temperatures	
Storage Temperature	-65 to +150°C
Operating Junction Temperature	+200°C

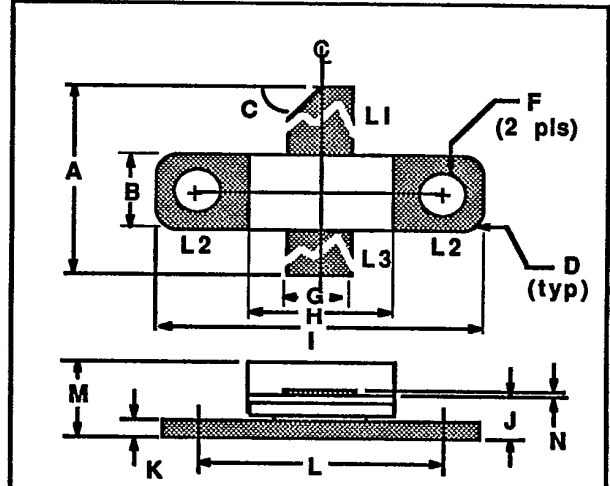

DIM	Millimeter	TOL	Inches	TOL	
L1 : C	A	17.78	.76	.70	.03
L2 : B	B	5.84	.13	.230	.005
L3 : E	C	45°	5°	45°	5°
	D	0.63R	.13	.025R	.005
	E	0.13	.02	.005	.001
	F	3.30 DIA	.13	.130 DIA	.005
	G	5.46	.13	.215	.005
	H	9.14	.13	.360	.005
	I	20.32	.13	.800	.005
	J	3.17	.13	.125	.005
	K	1.14	.13	.045	.010
	L	14.22	.13	.560	.005
	M	5.46	REF	.215	REF

POWER OUTPUT VS POWER INPUT (TYPICAL)

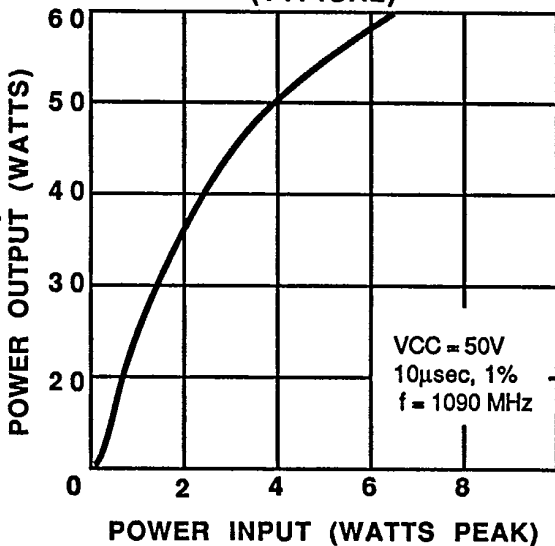

TYPICAL AMPLIFIER LINE UP
 Vcc = 50 Volts
 Frequency Range = 960-1215 MHz

0912-45-2

ELECTRICAL CHARACTERISTICS¹

SYMBOL	CHARACTERISTICS	TEST CONDITIONS	MIN.	TYP.	MAX.	UNITS
P _{out} ²	Power Output	f = 960-1215 MHz, V _{cc} = 50V	45			Watts
P _{in} ²	Power Input	At Rated Power Out			7	Watts
P _g ²	Power Gain			9.0		dB
η _c ²	Collector Efficiency			45		%
VSWR ²	Load Mismatch Tolerance				10:1	
BV _{ebo}	Breakdown Voltage (Emitter to Base)		I _c = 0A, I _e = 25mA	4		
BV _{ces}	Breakdown Voltage (Collector to Emitter)	V _{be} = 0A, I _c = 75mA	60			Volts
C _{ob}	Capacitance-Collector to Base	V _{cb} = 50V, f = 1.0 MHz		20		pF
h _{FE}	DC-Current Gain	I _c = 300mA, V _{ce} = 5V	10			
θ _{jc} ²	Thermal Resistance	T _c = +25°C			0.8	°C/W

Note 1: T_c = +25°C

Note 2: Pulse width = 10μsec, duty cycle = 1%

TYPICAL WIDEBAND CIRCUIT POWER OUTPUT VS FREQUENCY

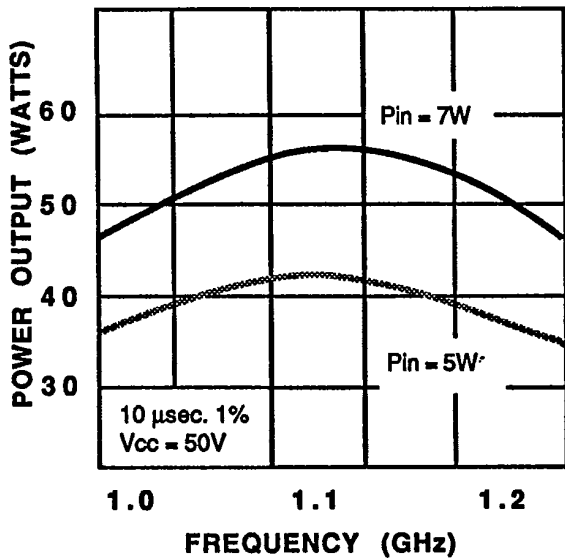

TYPICAL WIDEBAND CIRCUIT INPUT RETURN LOSS

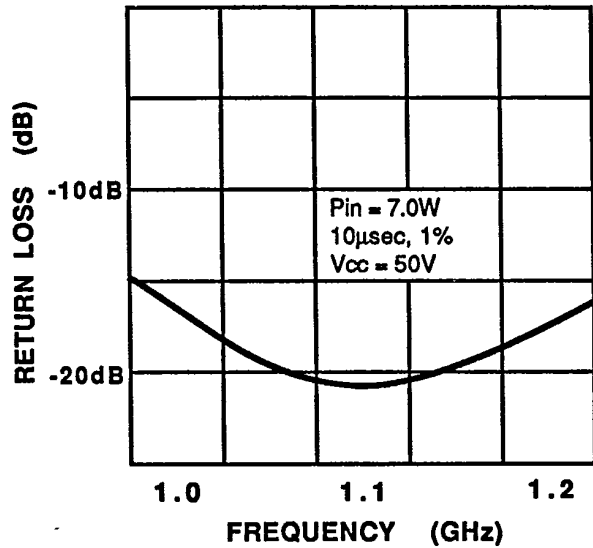

SPECIFICATIONS MAY BE SUBJECT TO CHANGE WITHOUT NOTICE

71

0912-45-3

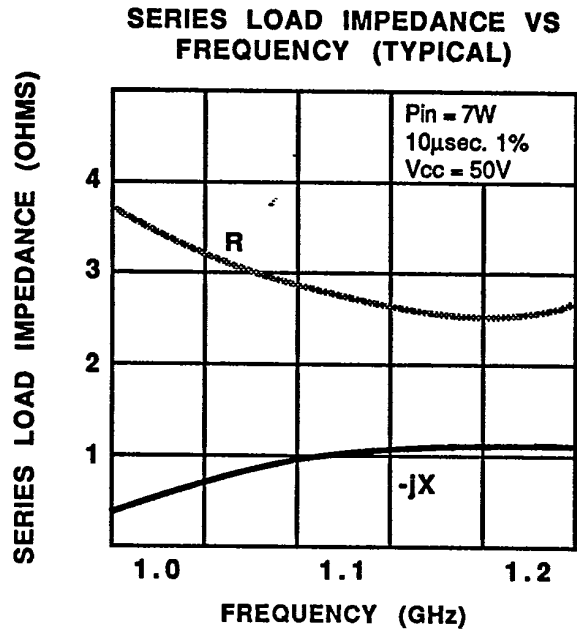
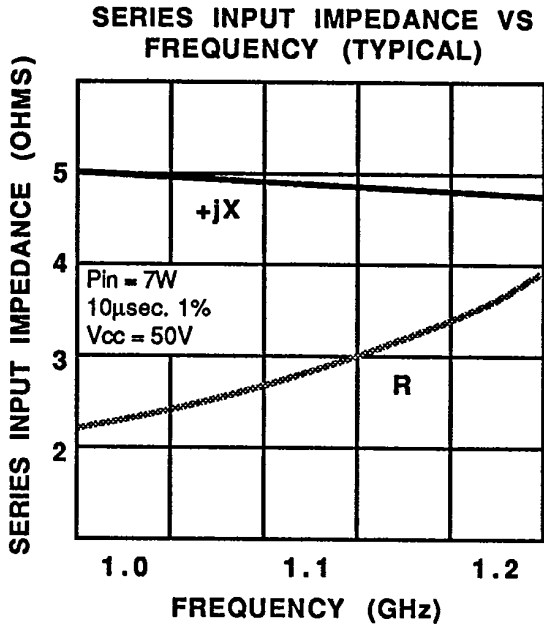

TYPICAL WIDEBAND CIRCUIT COLLECTOR EFFICIENCY vs. FREQUENCY

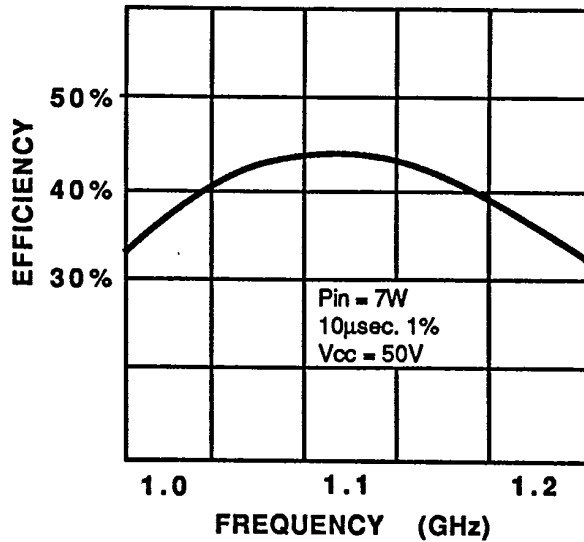

0912-45-4

0912-45 BROADBAND CIRCUIT

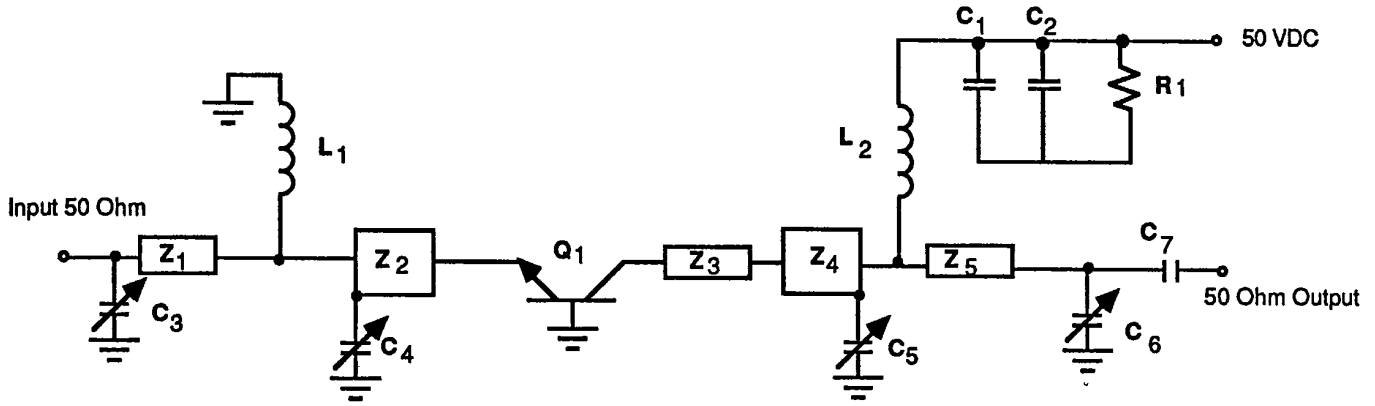

PC Board Material .010" Dielectric Teflon Fiberglass

$Z_1 = 50\Omega$, $.08\lambda = .027" w \times .59" L$
 $Z_2 = 2.7\Omega$, $.064\lambda = .80" w \times .44" L$
 $Z_3 = 10\Omega$, $.062\lambda = .20" w \times .443" L$
 $Z_4 = 3.7\Omega$, $.08\lambda = .55" w \times .55" L$
 $Z_5 = 50\Omega$, $.075\lambda = .027" w \times .56" L$
 $L_1 =$ Inductor #14 wire, 0.7" long
 $L_2 =$ Inductor #18 wire, 1.5" long

$C_1 =$ Capacitor 100pF "B" (100 mil) ATC
 $C_2 =$ Capacitor 68 μ fd, 75V Electrolytic
 $C_3, C_4, C_5, C_6 =$ Capacitor .35-3.5pF Piston Trimmer
 $C_4 =$ Capacitor 47pF "B" (100 mil) ATC
 $R_1 =$ Resistor, 15 Ω K 1/4W
 $Q_1 =$ Acrian Transistor 0912-45

All electrical lengths taken at 1.09 GHz.

92