

CDBFN140-HF Thru CDBFN160-HF

Voltage: 40 to 60 Volts

Current: 1.0 Amp

RoHS Device

Halogen free

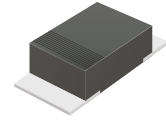

Features

- Batch process design, excellent power dissipation offers better reverse leakage current.
- Low profile surface mounted application in order to optimize board space.
- Low power loss, high efficiency.
- High current capability, low forward voltage drop.
- High surge capability.
- Guardring for overvoltage protection.
- Very tiny plastic SMD package.
- Ultra high-speed switching.
- Silicon epitaxial planar chip, metal silicon junction.
- Lead-free parts meet environmental standards of MIL-STD-19500 /228

Mechanical data

- Case: JEDEC SOD-323, Molded plastic
- Terminals: Solde plated, solderable per MIL-STD-750, method 2026.
- Polarity: Indicated by cathode band.
- Mounting position: Any
- Weight:0.008 gram(approx.).

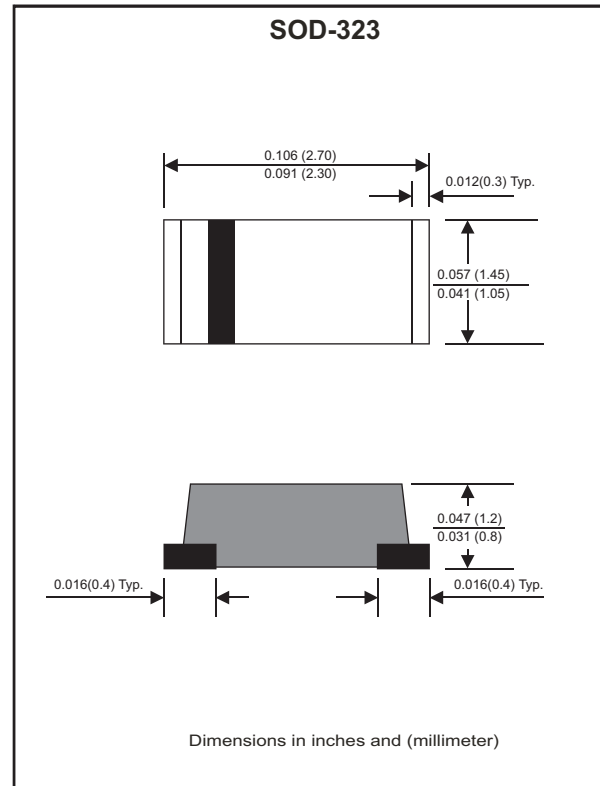

Maximum Ratings (at TA=25°C unless otherwise noted)

Parameter	Symbol	CDBFN 140-HF	CDBFN 160-HF	Unit
Repetitive peak reverse voltage	V_{RRM}	40	60	V
Maximum RMS voltage	V_{RMS}	28	42	V
Continuous reverse voltage	V_R	40	60	V
Maximum forward voltage @ $I_F=1.0A$	V_F	0.55	0.70	V
Forward rectified current	I_O	1.0		A
Forward surge current, 8.3ms half sine wave superimposed on rated load (JEDEC method)	I_{FSM}	30		A
Reverse current on $V_R=V_{RRM}$ @ $T_A=25^{\circ}C$ @ $T_A=100^{\circ}C$	I_R	0.5 10		mA
Typ. thermal resistance, junction to ambient air	$R_{\theta JA}$	90		$^{\circ}C/W$
Typ. diode junction capacitance (Note 1)	C_J	120		pF
Operating junction temperature	T_J	-55 to +125	-55 to +150	$^{\circ}C$
Storage temperature	T_{STG}	-65 to +150		$^{\circ}C$

Note 1: $f=1MHz$ and applied 4V DC reverse voltage.

Ratings and Characteristic Curves(CDBFN140-HF Thru CDBFN160-HF)

Fig.1- Typical Forward Current Derating Curve

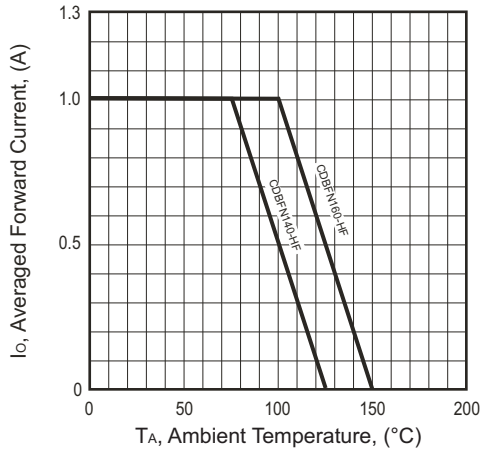

Fig.2- Typical Forward Characteristics

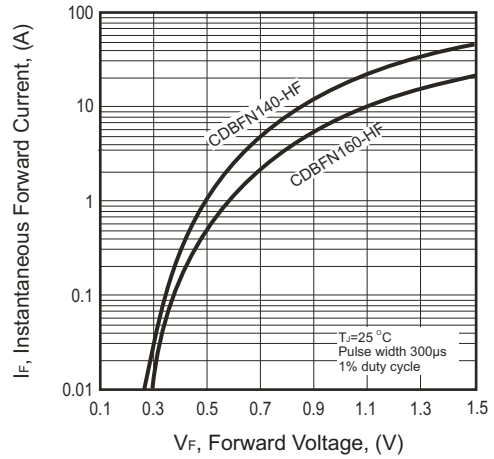

Fig.3- Maximum Non-repetitive Peak Forward Surge Current

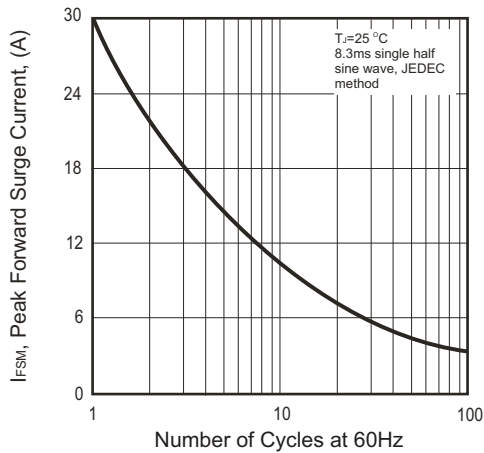

Fig.4- Typical Junction Capacitance

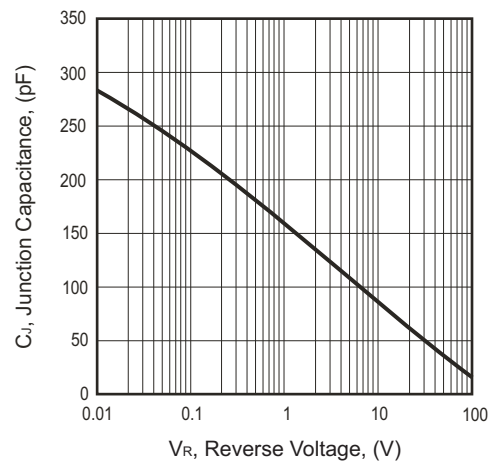
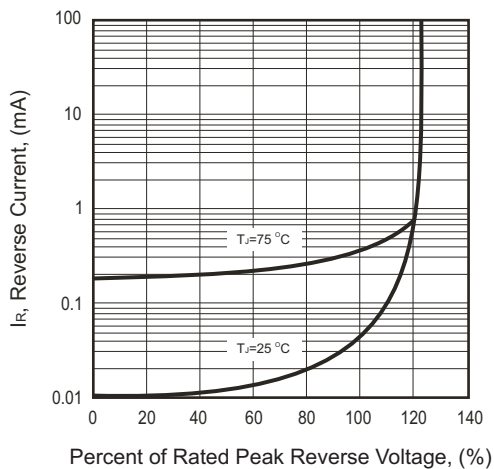
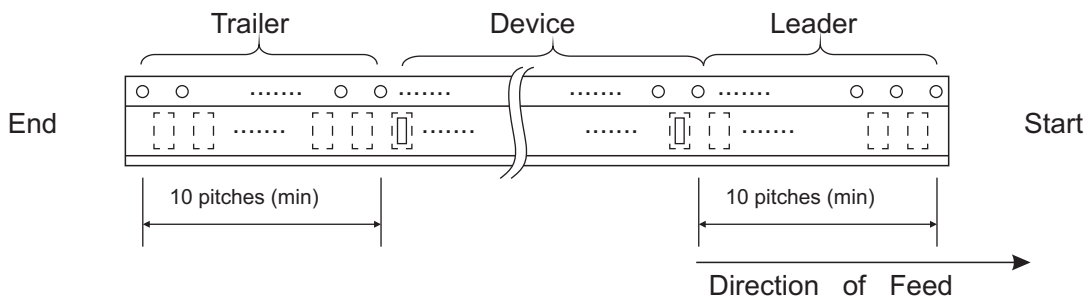
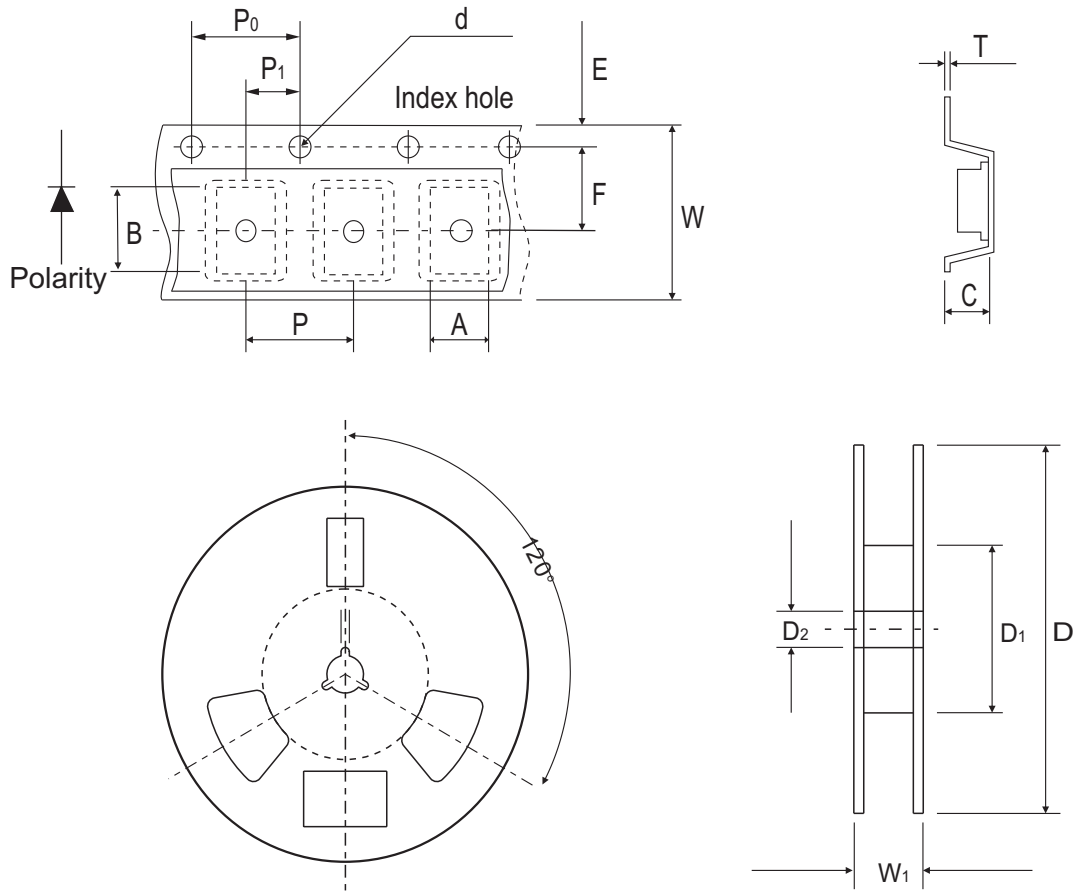

Fig.5- Typical Reverse Characteristics



Reel Taping Specification



SOD-323	SYMBOL	A	B	C	d	D	D1	D2
	(mm)	1.47 ± 0.10	2.95 ± 0.10	1.15 ± 0.10	1.50 ± 0.10	178 ± 1	62.0 MIN.	13.0 ± 0.50
	(inch)	0.057 ± 0.004	0.116 ± 0.004	0.045 ± 0.004	0.059 ± 0.004	7.008 ± 0.040	2.44 MIN.	0.512 ± 0.0197

SOD-323	SYMBOL	E	F	P	P0	P1	W	W1
	(mm)	1.75 ± 0.10	3.50 ± 0.10	4.00 ± 0.10	4.00 ± 0.10	2.00 ± 0.10	8.00 ± 0.30	11.4 ± 0.04
	(inch)	0.069 ± 0.004	0.138 ± 0.004	0.157 ± 0.004	0.157 ± 0.004	0.079 ± 0.004	0.315 ± 0.012	0.449 ± 0.0016

Marking Code

Part Number	Marking Code
CDBFN140-HF	14
CDBFN160-HF	16



XX=Product type marking code

Suggested PAD Layout

SIZE	SOD-323	
	(mm)	(inch)
A	1.500	0.059
B	1.000	0.039
C	1.300	0.051

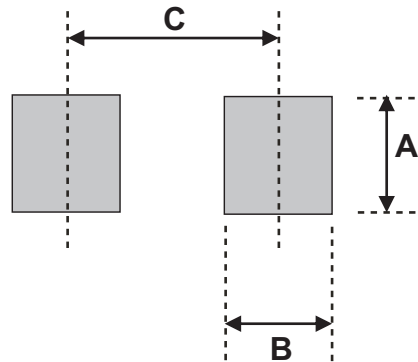

Standard Packaging

Case Type	Qty per Reel	Reel Size
	(Pcs)	(inch)
SOD-323	3000	7