

TO-92 Encapsulate Three-terminal Voltage Regulator

CJ78L05 Three-terminal positive voltage regulator

FEATURES

- Maximum Output Current I_O : 0.1 A
- Output Voltage V_O : 5 V
- Continuous Total Dissipation
 P_D : 0.625W ($T_a=25^\circ\text{C}$)

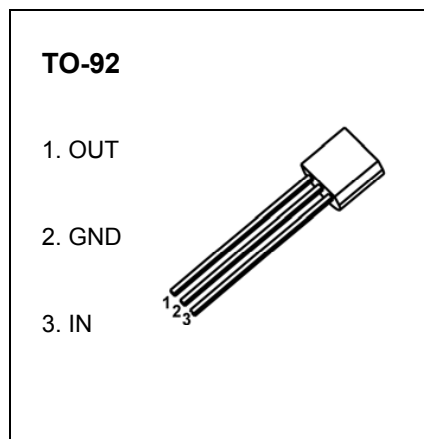

ABSOLUTE MAXIMUM RATINGS (Operating temperature range applies unless otherwise specified)

Parameter	Symbol	Value	Unit
Input Voltage	V_I	30	V
Operating Junction Temperature Range	T_{OPR}	0~+150	$^\circ\text{C}$
Storage Temperature Range	T_{STG}	-55~+150	$^\circ\text{C}$

ELECTRICAL CHARACTERISTICS AT SPECIFIED VIRTUAL JUNCTION TEMPERATURE ($V_i=10V, I_o=40mA, C_i=0.33\mu F, C_o=0.1\mu F$, unless otherwise specified)

Parameter	Symbol	Test conditions	Min	Typ	Max	Unit	
Output voltage	V_o	25°C	4.8	5.0	5.2	V	
		0-125 $^\circ\text{C}$	$7V \leq V_i \leq 20V, I_o=1mA \sim 40mA$	4.75	5.0	5.25	V
			$I_o=1mA \sim 70mA$	4.75	5.0	5.25	V
Load Regulation	ΔV_o	$I_o=1mA \sim 100mA$	25°C		15	60	mV
		$I_o=1mA \sim 40mA$	25°C		8	30	mV
Line regulation	ΔV_o	$7V \leq V_i \leq 20V$			32	150	mV
		$8V \leq V_i \leq 20V$	25°C		26	100	mV
Quiescent Current	I_q	25°C		3.8	6	mA	
Quiescent Current Change	ΔI_q	$8V \leq V_i \leq 20V$	0-125 $^\circ\text{C}$			1.5	mA
	ΔI_q	$1mA \leq I_o \leq 40mA$	0-125 $^\circ\text{C}$			0.1	mA
Output Noise Voltage	V_N	10Hz $\leq f \leq$ 100KHz	25°C		42	μV	
Ripple Rejection	RR	$8V \leq V_i \leq 20V, f=120\text{Hz}$	0-125 $^\circ\text{C}$	41	49	dB	
Dropout Voltage	V_d	25°C			1.7	V	

TYPICAL APPLICATION

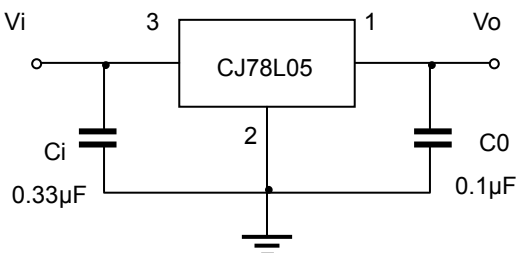

Note: Bypass capacitors are recommended for optimum stability and transient response and should be located as close as possible to the regulators.

Output Characteristics

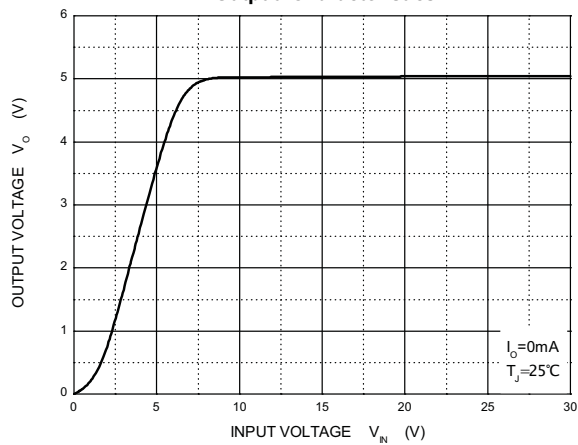

Dropout Characteristics

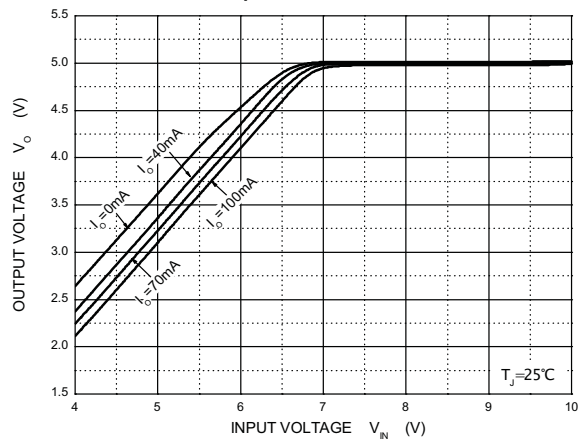

Quiescent Current vs Input Voltage

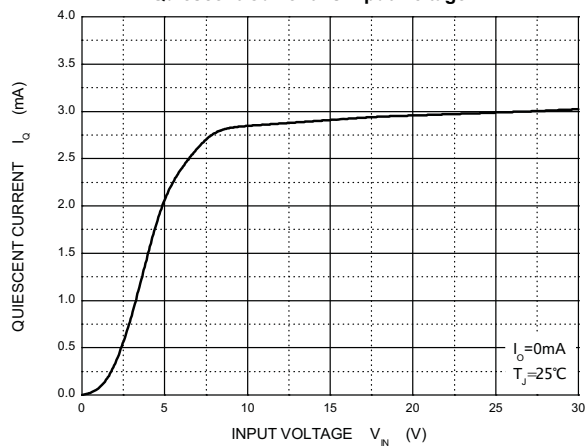

Quiescent Current vs Output Current

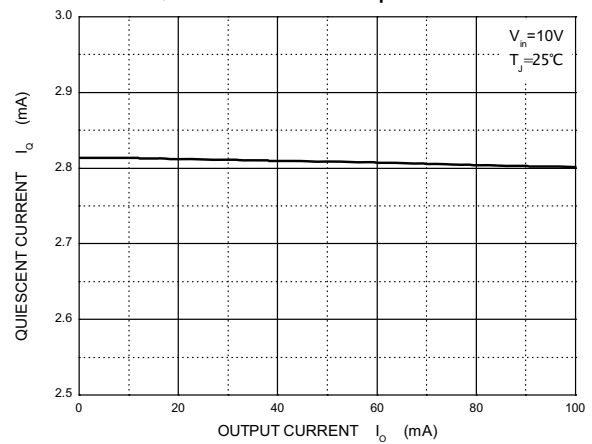

Output Voltage vs Ambient Temperature

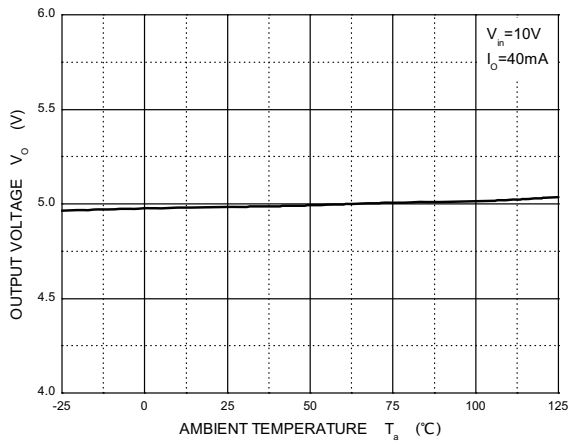

Current Cut-off Grid Voltage

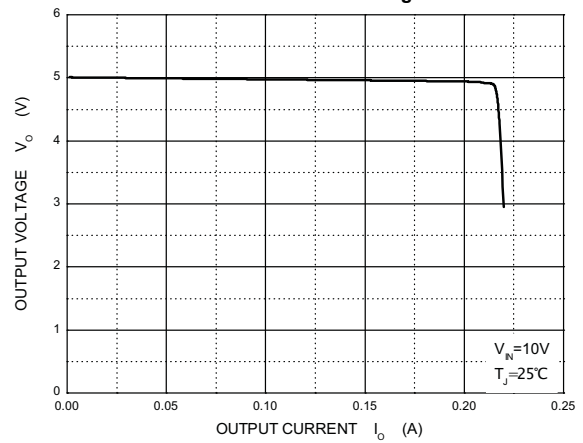

Power Derating Curve

