

Print mark detection photoelectric sensor in compact stainless steel housing

E3ZM-V

The detergent resistant photoelectric sensor in a robust stainless steel housing provides reliable detection of all common print marks in packaging applications.

- White LED for stable detection of differently colored print marks
- SUS 316L stainless steel housing
- Easy-to-use teach-in button or remote dynamic teach
- Fast response time of 50 μ s



Features

Reliable print mark detection within OMRON's most popular E3Z sensor family

The E3ZM-V provides reliable print mark detection in the compact sized E3Z housing. For packaging machine makers the E3Z family offers a complete sensor platform with one mounting concept simplifying installation and machine design.

• Space-saving design with an SUS316L housing

The compact design reduces volume by 90% compared to conventional mark sensors.



• Coaxial optical system

The coaxial optical system ensures stable detection of print marks on uneven surfaces.

Straight Sensing Object

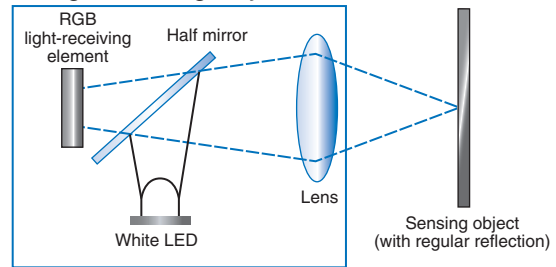

Inclined Sensing Object

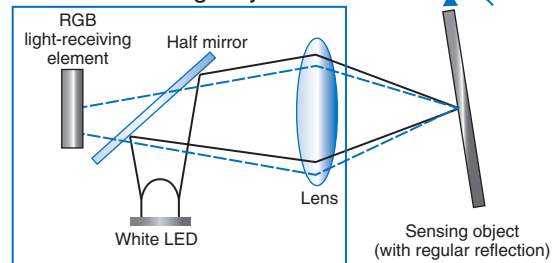

Water and detergent resistance

The housing is constructed of corrosion-resistant SUS316L, and the display cover is PES (polyethersulfone). Both materials are highly resistant to the corrosive effects of detergents and disinfectants. The IP69k tight housing construction ensures long sensor lifetime in often cleaned environments.

Same Durability as the E3ZM

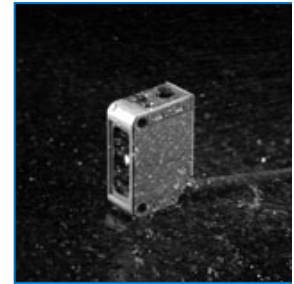

Reliable detection of differently colored print marks due to RGB signal processing

• RGB signal processing

The white LED and RGB signal processing ensure the stable detection of differently colored print marks. The processing algorithm provides a fast response time of 50 μ s.

Patent pending

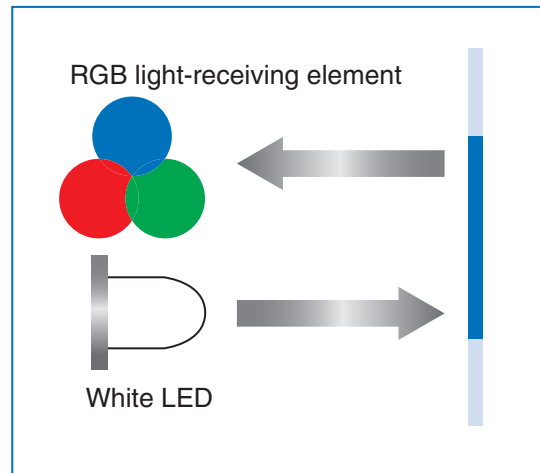

• Easy setting with 2-point or automatic teaching

2-point Teaching (Manual)

Simply aim the beam spot at the mark portion and background portion, and press the teaching button.



Automatic Teaching (Remote)

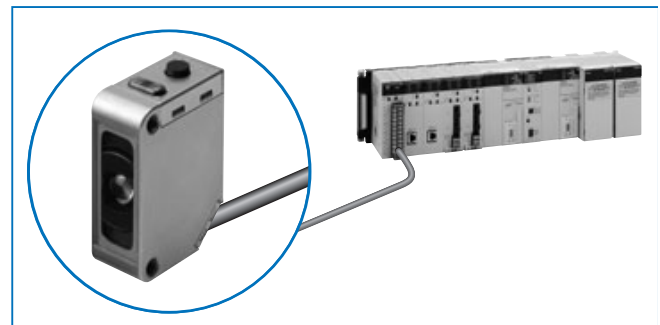

Send a pulse to the remote control input and have the mark pass by six times for automatic teaching.



Ordering Information

Sensor



 White light

Sensing method	Appearance	Connection method	Sensing distance			Model	
						NPN output	PNP output
Mark Sensor (Diffuse reflective)		Pre-wired (2 m)		12±2 mm	*1	E3ZM-V61 2M	E3ZM-V81 2M
		Connector (M8, 4 pins)				E3ZM-V66	E3ZM-V86

*1. A deviation of ±2 mm (typical value) can be handled for combinations of white, yellow, and black. Refer to page 5 for the detection capability for other color combinations.

Accessories









Sensor I/O Connectors

Size	Cable	Appearance	Cable type	Model	
M8 (4 pins)	Standard	Straight 	2 m	4-wire	XS3F-E421-402-A
			5 m		XS3F-E421-405-A
		L-shaped 	2 m		XS3F-E422-402-A
			5 m		XS3F-E422-405-A

Note 1: The outer cover of the cable is made of PVC (polyvinyl chloride), the nut is SUS316L, and the degree of protection is IP67. When high-pressure washing will be used, select an I/O Connector that has IP69K degree of protection.

Note 2: For detergent resistant cable connectors with stainless steel nuts see accessory datasheet E26E or contact your OMRON representative

Mounting Brackets

Appearance	Model (Material)	Quantity	Remarks	Appearance	Model (Metal material)	Quantity	Remarks
	E39-L153 (SUS304)	1	Mounting Brackets		E39-L98 (SUS304)	1	Protective Cover Bracket *1
	E39-L104 (SUS304)	1			E39-L150 (SUS304)	1 set	(Sensor adjuster) Easily mounted to the aluminum frame rails of conveyors and easily adjusted. For vertical angle adjustment
	E39-L43 (SUS304)	1	Horizontal Mounting Bracket *1		E39-L151 (SUS304)	1 set	
	E39-L142 (SUS304)	1	Horizontal Protective Cover Bracket *1				
	E39-L44 (SUS304)	1	Rear Mounting Bracket		E39-L144 (SUS304)	1 set	Compact Protective Cover Bracket *1

*1. Cannot be used for Standard Connector models.

Ratings and Specifications

Sensing method		Diffuse reflective (mark detection)
Model	NPN output	E3ZM-V61/-V66
Item	PNP output	E3ZM-V81/-V86
Sensing distance	12±2 mm *1	
Sensing range	Depends on the combination of colors. Refer to <i>Engineering Data</i> on page 5 for details.	
Spot diameter	2-mm dia. max.	
Light source (wavelength)	White LED (450 to 700 nm)	
Power supply voltage	10 to 30 VDC, including 10% ripple (p-p)	
Power consumption	600 mW max. (current consumption for a 30-V power supply voltage: 20 mA max.)	
Control output	Load power supply voltage: 30 VDC max., Load current: 100 mA max. (Residual voltage: 2 V max.) Open-collector output (NPN/PNP output depending on model)	
Remote control input	NPN output ON: Short-circuit to 0 V, or 1.5 V max. (source current: 1 mA max.) NPN output OFF: Open or Vcc 1.5 V to Vcc (leakage current: 0.1 mA max.) PNP output ON: Vcc 1.5 V to Vcc (sink current: 1 mA max.) PNP output OFF: Open or 1.5 V max. (leakage current: 0.1 mA max.)	
Operating modes	Set in the order of the teaching operation. *2	
Protection circuits	Reversed power supply polarity, Load short-circuit protection, and Reversed output polarity protection	
Response time	Operate or reset: 50 µs max.	
Sensitivity adjustment	Teaching method	
Ambient illumination	(Receiver side) Incandescent lamp: 3,000 lx max., Sunlight: 10,000 lx max.	
Ambient temperature range	Operating: -40 to 60°C *3, Storage: -40 to 70°C (with no icing or condensation)	
Ambient humidity range	Operating: 35% to 85%, Storage: 35% to 95% (with no condensation)	
Insulation resistance	20 M min. (at 500 VDC)	
Dielectric strength	1,000 VAC at 50/60 Hz for 1 min	
Vibration resistance (destruction)	10 to 55 Hz, 1.5-mm double amplitude for 2 h each in X, Y, and Z directions	
Shock resistance (destruction)	500 m/s ² for 3 times each in X, Y, and Z directions	
Degree of protection	IEC 60529: IP67, DIN 40050-9: IP69K *4	
Connection method	Pre-wired cable (standard length: 2 m) or M8 4-pin connector	
Indicator	Operating indicator (yellow), Stability indicator (green), and Teaching indicator (red)	
Weight (packed state)	Pre-wired models (2-m cable): Approx. 85 g Connector models: Approx. 35 g	
Materials	Housing	SUS316L
	Lens	PMMA (polymethylmethacrylate)
	Indication	PES (polyethersulfone)
	Buttons	Fluoro rubber
	Cable	PVC (polyvinyl chloride)
Accessories	Instruction sheet	

*1. A deviation of ±2 mm (typical value) can be handled for combinations of white, yellow, and black. Refer to page 5 for the detection capabilities for other colors.

*2. Mark Sensor output switching: When teaching, specify the ON color first and the OFF color second.

*3. Do not bend the cable in temperatures of -25°C or lower.

*4. For connector models IP69k rating is with connector attached.

Standard Sensing Object for the Mark Sensor

Color	Munsell color notation
White	N9.5
Red	4R 4.5/12.0
Yellow-red	4YR 6.0/11.5
Yellow	5Y 8.5/11.0
Yellow-green	3GY 6.5/10.0
Green	3G 6.5/9.0
Blue-green	5BG 4.5/10.0
Blue	3PB 5.0/10.0
(Black)	(N2.0)

Engineering Data (Typical)

Color vs. Detection Capability

E3ZM-V□□

Teaching Capabilities

	White	Red	Yellow-red	Yellow	Yellow-green	Green	Blue-green	Blue	Black
White	○	○	○	○	○	○	○	○	○
Red	○	○	○	○	○	○	○	○	○
Yellow-red	○	○	○	○	○	○	○	○	○
Yellow	○	○	○	○	○	○	○	○	○
Yellow-green	○	○	○	○	○	○	○	○	○
Green	○	○	○	○	○	○	○	○	○
Blue-green	○	○	○	○	○	○	○	○	○
Blue	○	○	○	○	○	○	○	○	○
Black	○	○	○	○	○	○	○	○	○

Note: The above chart shows the combinations of colors for which teaching is possible at a sensing distance of 12 mm.

Detectable Ranges

E3ZM-V□□

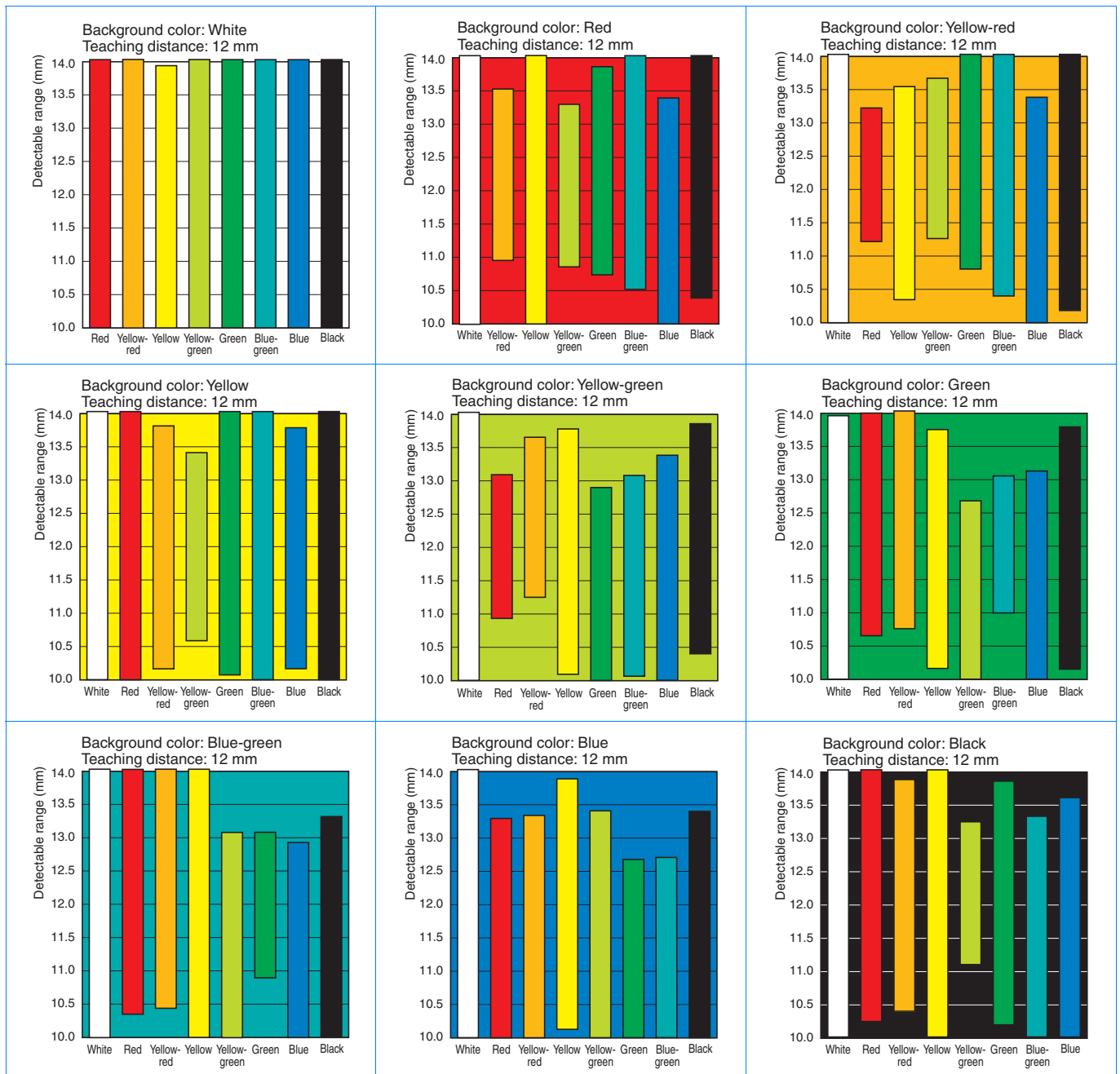

Excess Gain vs. Distance

E3ZM-V□□

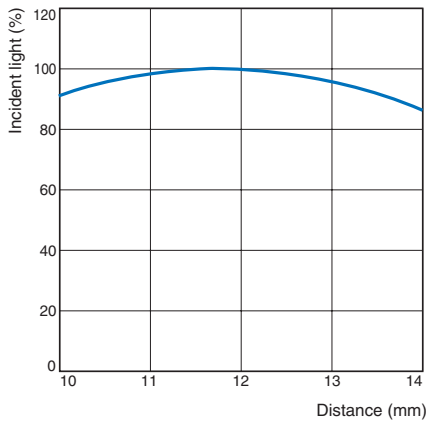

Angle vs. Incident Characteristics

E3ZM-V□□

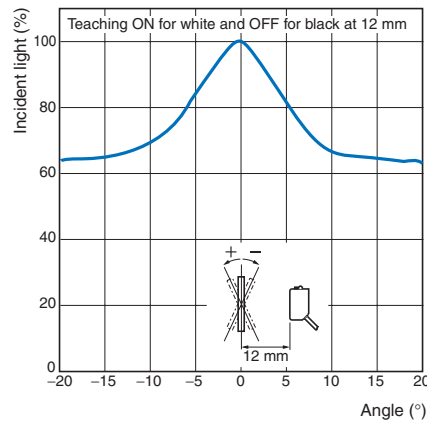

E3ZM-V□□

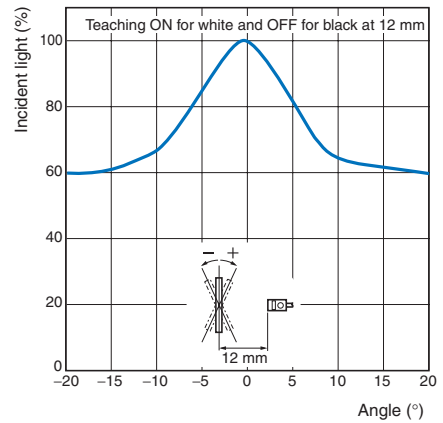

I/O Circuit Diagrams

NPN Output

Model	Timing charts	Output circuit
E3ZM-V61 E3ZM-V66	<p>Between brown (1) and black (4) leads</p>	<p>M8 Connector Pin Arrangement</p>

PNP Output

Model	Timing charts	Output circuit
E3ZM-V81 E3ZM-V86	<p>Between blue (3) and black (4) leads</p>	<p>M8 Connector Pin Arrangement</p>

Plugs (Sensor I/O Connectors)

M8 4-pin Connectors

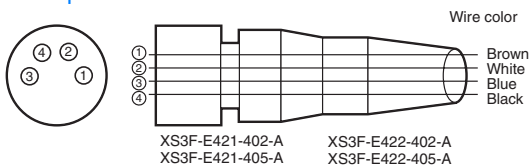

Classification	Wire color	Connector pin No.	Application
DC	Brown	1	Power supply (+v)
	White	2	Remote control input
	Blue	3	Power supply (0 V)
	Black	4	Output

Note: The above M8 Connectors made by OMRON are IP67. Do not use them in an environment where IP69K is required.

Nomenclature

Teaching Models

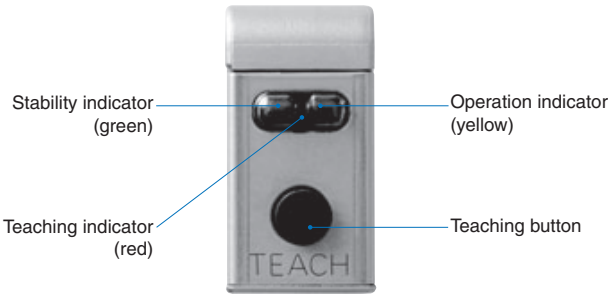

Safety Precautions

Refer to *Warranty and Limitations of Liability* on page 12.

WARNING

This product is not designed or rated for directly or indirectly ensuring safety of persons. Do not use it for such a purpose.



CAUTION

Do not use the product with voltage in excess of the rated voltage. Excess voltage may result in malfunction or fire.



Never use the product with an AC power supply. Otherwise, explosion may result.



When cleaning the product, do not apply a high-pressure spray of water to one part of the product. Otherwise, parts may become damaged and the degree of protection may be degraded.



Precautions for Safe Use

The following precautions must be observed to ensure safe operation of the Sensor.

Operating Environment

Do not use the Sensor in an environment where explosive or flammable gas is present.

Connecting Connectors

Be sure to hold the connector cover when inserting or removing the connector.

When using an XS3F Connector, be sure to tighten the connector lock by hand; do not use pliers or other tools.

If the tightening is insufficient, the degree of protection will not be maintained and the Sensor may become loose due to vibration. The appropriate tightening torque is 0.3 to 0.4 N·m. When using another, commercially available connector, follow the usage and tightening torque instructions provided by the manufacturer.

Load

Do not use a load that exceeds the rated load.

Low-temperature Environments

Do not touch the metal surface with your bare hands when the temperature is low. Touching the surface may result in a cold burn.

Oily Environments

Do not use the Sensor in oily environments. They may damage parts and reduce the degree of protection.

Modifications

Do not attempt to disassemble, repair, or modify the Sensor.

Outdoor Use

Do not use the Sensor in locations subject to direct sunlight.

Cleaning

Do not use thinner, alcohol, or other organic solvents. Otherwise, the optical properties and degree of protection may be degraded.

Cleaning

Do not use highly concentrated cleaning agents. Otherwise, malfunction may result. Also, do not use high-pressure water with a level of pressure that exceeds the stipulated level. Otherwise, the degree of protection may be reduced.

Surface Temperature

Burn injury may occur. The Sensor surface temperature rises depending on application conditions, such as the ambient temperature and the power supply voltage. Use caution when operating or performing maintenance on the Sensor.

Cable Bending

Do not bend the cable in temperatures of -25° C or below. Otherwise, the cable may be damaged.

Precautions for Correct Use

Do not use the Sensor in any atmosphere or environment that exceeds the ratings.

Do not install the Sensor in the following locations.

- (1) Locations subject to direct sunlight
- (2) Locations subject to condensation due to high humidity
- (3) Locations subject to corrosive gas
- (4) Locations where the Sensor may receive direct vibration or shock

Connecting and Mounting

- (1) The maximum power supply voltage is 30 VDC. Before turning the power ON, make sure that the power supply voltage does not exceed the maximum voltage.
- (2) Laying Sensor wiring in the same conduit or duct as high-voltage wires or power lines may result in malfunction or damage due to induction. As a general rule, wire the Sensor in a separate conduit or use shielded cable.
- (3) Use an extension cable with a minimum thickness of 0.3 mm² and less than 50 m long.
- (4) Do not pull on the cable with excessive force.
- (5) Pounding the Photoelectric Sensor with a hammer or other tool during mounting will impair water resistance. Also, use M3 screws.
- (6) Mount the Sensor either using the bracket (sold separately) or on a flat surface.
- (7) Be sure to turn OFF the power supply before inserting or removing the connector.

Power Supply

If a commercial switching regulator is used, ground the FG (frame ground) terminal.

Power Supply Reset Time

The Sensor will be able to detect objects 100 ms after the power supply is tuned ON. Start using the Sensor 100 ms or more after turning ON the power supply. If the load and the Sensor are connected to separate power supplies, be sure to turn ON the Sensor first.

Turning OFF the Power Supply

Output pulses may be generated even when the power supply is OFF.

Therefore, it is recommended to first turn OFF the power supply for the load or the load line.

Load Short-circuit Protection

This Sensor is equipped with load short-circuit protection, but be sure to not short circuit the load. Be sure to not use an output current flow that exceeds the rated current. If a load short circuit occurs, the output will turn OFF, so check the wiring before turning ON the power supply again. The short-circuit protection circuit will be reset. The load shortcircuit protection will operate when the current flow reaches 1.8 times the rated load current. When using a capacitive load, use an inrush current of 1.8 times the rated load current or lower.

Water Resistance

Do not use the Sensor in water, rainfall, or outdoors.

When disposing of the Sensor, treat it as industrial waste.

Mounting Diagram

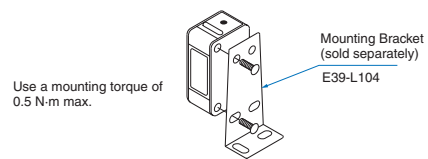

Resistance to Detergents, Disinfectants, and Chemicals

- The Sensor will maintain sufficient performance in typical detergents and disinfectants, but performance may suffer in some types of detergents, disinfectants, and chemicals. Refer to the following table prior to use.
- The E3ZM has passed detergent and disinfectant resistance testing for the substances listed in the following table. Use this table as a guide when considering detergents and disinfectants.

Type	Product name	Concentration	Temperature	Time
Chemicals	Sodium hydroxide, NaOH	1.5%	70°C	240 h
	Potassium hydroxide, KOH	1.5%	70°C	240 h
	Phosphoric acid, H ₃ PO ₄	2.5%	70°C	240 h
	Sodium hypochlorite, NaClO	0.3%	25°C	240 h
	Hydrogen peroxide, H ₂ O ₂	6.5%	25°C	240 h
Alkaline foaming cleansers	Topax 66s (Ecolab)	3.0%	70°C	240 h
Acidic foaming cleansers	Topax 56 (Ecolab)	5.0%	70°C	240 h
Disinfectants	Oxonia Active 90 (Ecolab)	1.0%	25°C	240 h
	TEK121 (ABC Compounding)	1.1%	25°C	240 h

Note: The Sensor was immersed in the above chemicals, detergents, and disinfectants for 240 h at the temperatures given, and then passed an insulation resistance test at 100 MW min.

Restrictions on Sensing Objects

Do not use this Sensor if the color and pattern of the background are similar to those of the mark.

Detection of Glossy Objects

Mount the Sensor at an angle of 5° to 15°, as shown in the following diagram. This will improve the mark detection capability.

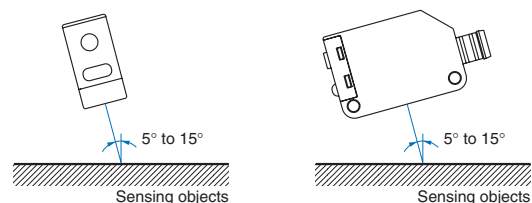

Operating Procedure

Two-point Teaching Using Teaching Button

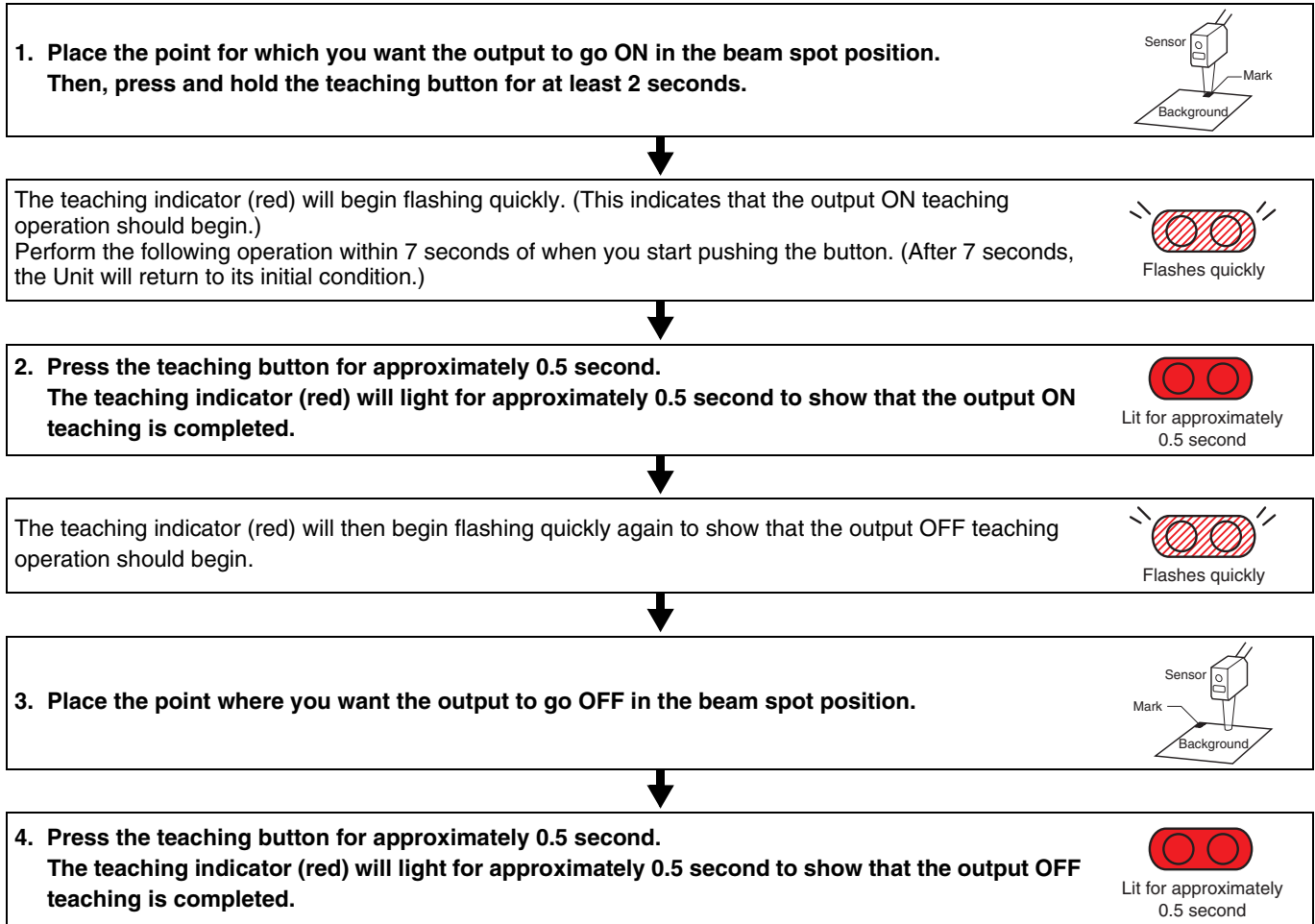

When Teaching Is Successful

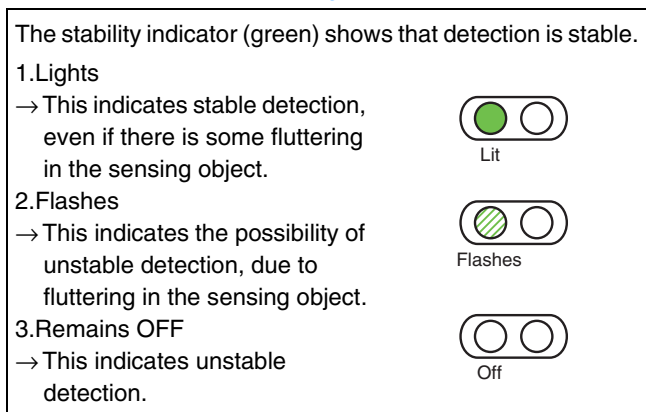

When Teaching Is Not Successful

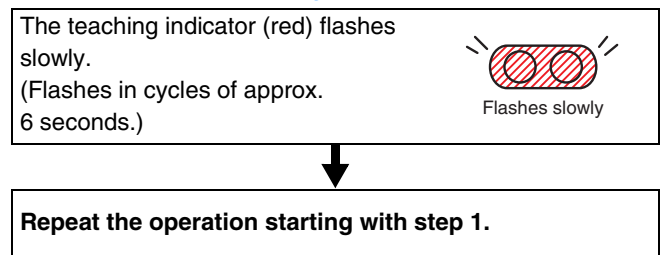

The Sensor enters normal operating condition.

	Stable detection	Unstable detection
ON point	Lit Lit	Off Lit
OFF point	Lit Off	Off Off

Automatic teaching (Remote)

1. Send a pulse with a duration of at least 2 s but less than 10 s min. to the remote control input (pink).
2. Teaching will be performed automatically when the mark (the light level with the shorter detection time) passes through the beam spot.

Make sure the mark passes through the beam spot for at least 1.5 ms.

Pass the mark through the beam spot at least seven times to complete the teaching process.

3. Detection will begin and the output will turn ON when the mark (the light level with the shorter detection time) is detected.

Note: Determine when teaching has been completed by confirming that the output turns ON for the mark and OFF for the background. If the output does not turn ON for the mark and OFF for the background within one minute after the remote control input is applied, teaching has not been successful. Apply the remote control input again.

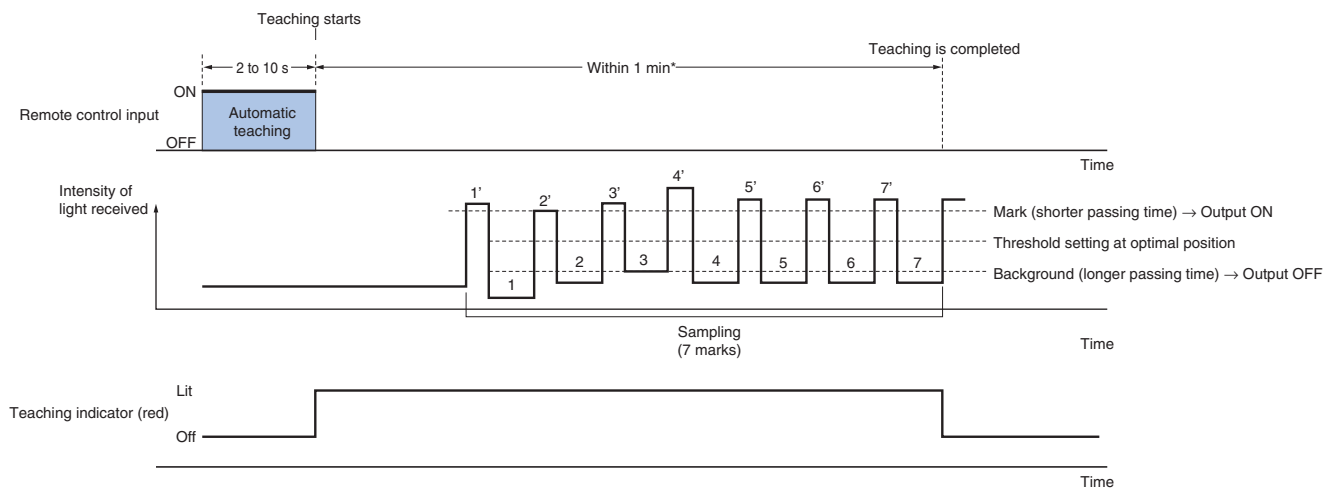

*If seven marks do not pass within one minute of the remote control input, the teaching operation will be cancelled.

Precautions for Using Automatic Teaching (Remote)

- With automatic teaching (remote), the output is always turned ON for the light level with the shorter detection time. Use 2-point teaching (manual) to turn OFF the output for the light level with the shorter detection time.
- Faulty detection is possible when using automatic teaching (remote) if there is considerable movement in the sensing object or if the surface of the object is stepped or contains protrusions. In cases such as these, use 2-point teaching.
- Do not use automatic teaching for backgrounds that are not monochrome.

Dimensions

Sensors

Mark Sensor
(Diffuse reflective)
Pre-wired Models
E3ZM-V61
E3ZM-V81

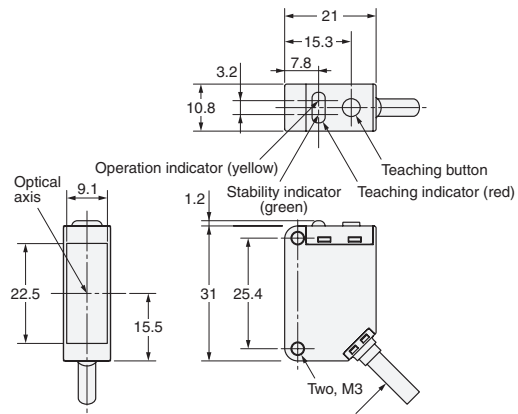

4-dia. Vinyl-insulated round cable with 4 conductors
(Conductor cross section: 0.2 mm² (AWG.24), Insulator diameter: 1.1 mm), Standard length: 2 m

Mark Sensor
(Diffuse reflective)
M8 Connector
E3ZM-V66
E3ZM-V86

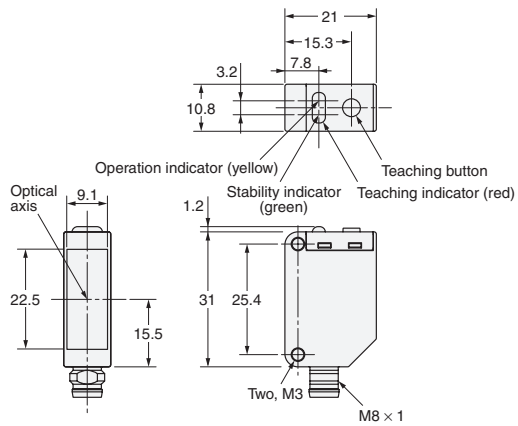

READ AND UNDERSTAND THIS DOCUMENT

Please read and understand this document before using the products. Please consult your OMRON representative if you have any questions or comments.

WARRANTY

OMRON's exclusive warranty is that the products are free from defects in materials and workmanship for a period of one year (or other period if specified) from date of sale by OMRON.

OMRON MAKES NO WARRANTY OR REPRESENTATION, EXPRESS OR IMPLIED, REGARDING NON-INFRINGEMENT, MERCHANTABILITY, OR FITNESS FOR PARTICULAR PURPOSE OF THE PRODUCTS. ANY BUYER OR USER ACKNOWLEDGES THAT THE BUYER OR USER ALONE HAS DETERMINED THAT THE PRODUCTS WILL SUITABLY MEET THE REQUIREMENTS OF THEIR INTENDED USE. OMRON DISCLAIMS ALL OTHER WARRANTIES, EXPRESS OR IMPLIED.

LIMITATIONS OF LIABILITY

OMRON SHALL NOT BE RESPONSIBLE FOR SPECIAL, INDIRECT, OR CONSEQUENTIAL DAMAGES, LOSS OF PROFITS OR COMMERCIAL LOSS IN ANY WAY CONNECTED WITH THE PRODUCTS, WHETHER SUCH CLAIM IS BASED ON CONTRACT, WARRANTY, NEGLIGENCE, OR STRICT LIABILITY.

In no event shall responsibility of OMRON for any act exceed the individual price of the product on which liability is asserted.

IN NO EVENT SHALL OMRON BE RESPONSIBLE FOR WARRANTY, REPAIR, OR OTHER CLAIMS REGARDING THE PRODUCTS UNLESS OMRON'S ANALYSIS CONFIRMS THAT THE PRODUCTS WERE PROPERLY HANDLED, STORED, INSTALLED, AND MAINTAINED AND NOT SUBJECT TO CONTAMINATION, ABUSE, MISUSE, OR INAPPROPRIATE MODIFICATION OR REPAIR.

SUITABILITY FOR USE

THE PRODUCTS CONTAINED IN THIS DOCUMENT ARE NOT SAFETY RATED. THEY ARE NOT DESIGNED OR RATED FOR ENSURING SAFETY OF PERSONS, AND SHOULD NOT BE RELIED UPON AS A SAFETY COMPONENT OR PROTECTIVE DEVICE FOR SUCH PURPOSES. Please refer to separate catalogs for OMRON's safety rated products.

OMRON shall not be responsible for conformity with any standards, codes, or regulations that apply to the combination of products in the customer's application or use of the product.

At the customer's request, OMRON will provide applicable third party certification documents identifying ratings and limitations of use that apply to the products. This information by itself is not sufficient for a complete determination of the suitability of the products in combination with the end product, machine, system, or other application or use.

The following are some examples of applications for which particular attention must be given. This is not intended to be an exhaustive list of all possible uses of the products, nor is it intended to imply that the uses listed may be suitable for the products:

- Outdoor use, uses involving potential chemical contamination or electrical interference, or conditions or uses not described in this document.
- Nuclear energy control systems, combustion systems, railroad systems, aviation systems, medical equipment, amusement machines, vehicles, safety equipment, and installations subject to separate industry or government regulations.
- Systems, machines, and equipment that could present a risk to life or property.

Please know and observe all prohibitions of use applicable to the products.

NEVER USE THE PRODUCTS FOR AN APPLICATION INVOLVING SERIOUS RISK TO LIFE OR PROPERTY WITHOUT ENSURING THAT THE SYSTEM AS A WHOLE HAS BEEN DESIGNED TO ADDRESS THE RISKS, AND THAT THE OMRON PRODUCT IS PROPERLY RATED AND INSTALLED FOR THE INTENDED USE WITHIN THE OVERALL EQUIPMENT OR SYSTEM.

PERFORMANCE DATA

Performance data given in this document is provided as a guide for the user in determining suitability and does not constitute a warranty. It may represent the result of OMRON's test conditions, and the users must correlate it to actual application requirements. Actual performance is subject to the OMRON Warranty and Limitations of Liability.

CHANGE IN SPECIFICATIONS

Product specifications and accessories may be changed at any time based on improvements and other reasons.

It is our practice to change model numbers when published ratings or features are changed, or when significant construction changes are made. However, some specifications of the product may be changed without any notice. When in doubt, special model numbers may be assigned to fix or establish key specifications for your application on your request. Please consult with your OMRON representative at any time to confirm actual specifications of purchased products.

DIMENSIONS AND WEIGHTS

Dimensions and weights are nominal and are not to be used for manufacturing purposes, even when tolerances are shown.

ERRORS AND OMISSIONS

The information in this document has been carefully checked and is believed to be accurate; however, no responsibility is assumed for clerical, typographical, or proofreading errors, or omissions.

PROGRAMMABLE PRODUCTS

OMRON shall not be responsible for the user's programming of a programmable product, or any consequence thereof.

COPYRIGHT AND COPY PERMISSION

This document shall not be copied for sales or promotions without permission.

This document is protected by copyright and is intended solely for use in conjunction with the product. Please notify us before copying or reproducing this document in any manner, for any other purpose. If copying or transmitting this document to another, please copy or transmit it in its entirety.

Cat. No. E389-E2-01-X

In the interest of product improvement, specifications are subject to change without notice.

OMRON EUROPE B.V.

Wegalaan 67-69,
 NL-2132 JD, Hoofddorp,
 The Netherlands
 Phone: +31 23 568 13 00
 Fax: +31 23 568 13 88
 www.industrial.omron.eu