



# STS 2306E

SamHop Microelectronics Corp.

Jan. 10 2008 Ver1.0

## N-Channel Enhancement Mode Field Effect Transistor

PRODUCT SUMMARY		
V <sub>DS</sub>	I <sub>D</sub>	R <sub>DS(ON)</sub> (mΩ) Max
20V	6.5A	30 @ V <sub>GS</sub> = 4.5V 40 @ V <sub>GS</sub> = 2.5V

### FEATURES

- Super high dense cell design for low R<sub>DS(ON)</sub>.
- Rugged and reliable.
- Surface Mount Package.
- ESD Protected.



### ABSOLUTE MAXIMUM RATINGS (T<sub>A</sub>=25°C unless otherwise noted)

Parameter	Symbol	Limit	Unit
Drain-Source Voltage	V <sub>DS</sub>	20	V
Gate-Source Voltage	V <sub>GS</sub>	±10	V
Drain Current-Continuous <sup>a</sup> @ T <sub>J</sub> =25°C -Pulsed <sup>b</sup>	I <sub>D</sub>	6.5	A
	I <sub>DM</sub>	24	A
Drain-Source Diode Forward Current <sup>a</sup>	I <sub>S</sub>	1.25	A
Maximum Power Dissipation <sup>a</sup>	P <sub>D</sub>	1.25	W
Operating Junction and Storage Temperature Range	T <sub>J</sub> , T <sub>STG</sub>	-55 to 150	°C

### THERMAL CHARACTERISTICS

Thermal Resistance, Junction-to-Ambient <sup>a</sup>	R <sub>θJA</sub>	100	°C/W
--	------------------	-----	------

# STS 2306E

ELECTRICAL CHARACTERISTICS ( $T_A = 25^\circ\text{C}$  unless otherwise noted)

Parameter	Symbol	Condition	Min	Typ <sup>c</sup>	Max	Unit
<b>OFF CHARACTERISTICS</b>						
Drain-Source Breakdown Voltage	$BV_{DS}$	$V_{GS} = 0V, I_D = 250\mu A$	20			V
Zero Gate Voltage Drain Current	$I_{DSS}$	$V_{DS} = 16V, V_{GS} = 0V$			1	$\mu A$
Gate-Body Leakage	$I_{GSS}$	$V_{GS} = \pm 10V, V_{DS} = 0V$			$\pm 10$	$\mu A$
<b>ON CHARACTERISTICS<sup>b</sup></b>						
Gate Threshold Voltage	$V_{GS(th)}$	$V_{DS} = V_{GS}, I_D = 250\mu A$	0.5	0.9	1.5	V
Drain-Source On-State Resistance	$R_{DS(ON)}$	$V_{GS} = 4.5V, I_D = 6A$		24	30	m ohm
		$V_{GS} = 2.5V, I_D = 3A$		32	40	m ohm
Forward Transconductance	$g_{FS}$	$V_{DS} = 7V, I_D = 5A$		16		S
<b>DYNAMIC CHARACTERISTICS<sup>c</sup></b>						
Input Capacitance	$C_{ISS}$	$V_{DS} = 10V, V_{GS} = 0V$ $f = 1.0MHz$		540		pF
Output Capacitance	$C_{OSS}$			160		pF
Reverse Transfer Capacitance	$C_{RSS}$			100		pF
<b>SWITCHING CHARACTERISTICS<sup>c</sup></b>						
Turn-On Delay Time	$t_{D(ON)}$	$V_{DD} = 10V,$ $I_D = 1A,$ $V_{GEN} = 4.5V,$ $R_L = 10\text{ ohm}$ $R_{GEN} = 10\text{ ohm}$		15		ns
Rise Time	$t_r$			20		ns
Turn-Off Delay Time	$t_{D(OFF)}$			36		ns
Fall Time	$t_f$			11		ns
Total Gate Charge	$Q_g$	$V_{DS} = 10V, I_D = 6A, V_{GS} = 4.5V$		6.4		nC
		$V_{DS} = 10V, I_D = 6A, V_{GS} = 2.5V$		4.6		nC
Gate-Source Charge	$Q_{gs}$	$V_{DS} = 10V, I_D = 6A$		1.1		nC
Gate-Drain Charge	$Q_{gd}$	$V_{GS} = 4.5V$		2.8		nC

# STS 2306E

ELECTRICAL CHARACTERISTICS ( $T_A=25^\circ\text{C}$  unless otherwise noted)

Parameter	Symbol	Condition	Min	Typ <sup>c</sup>	Max	Unit
DRAIN-SOURCE DIODE CHARACTERISTICS <sup>b</sup>						
Diode Forward Voltage	$V_{SD}$	$V_{GS} = 0V, I_s = 1.25A$		0.76	1.2	V

## Notes

- a. Surface Mounted on FR4 Board,  $t \leq 10\text{sec}$ .
- b. Pulse Test: Pulse Width  $\leq 300\mu\text{s}$ , Duty Cycle  $\leq 2\%$ .
- c. Guaranteed by design, not subject to production testing.

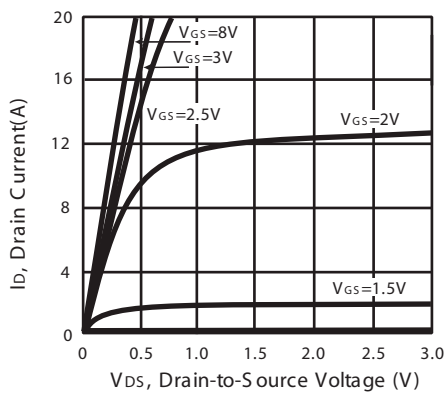

Figure 1. Output Characteristics

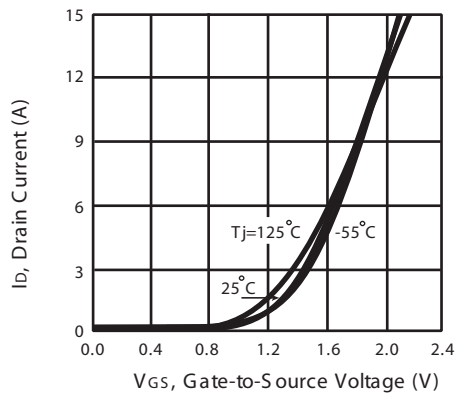

Figure 2. Transfer Characteristics

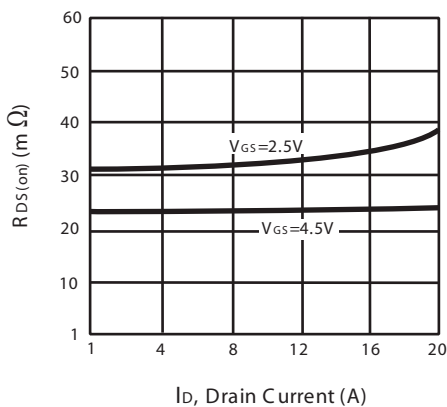

Figure 3. On-Resistance vs. Drain Current and Gate Voltage

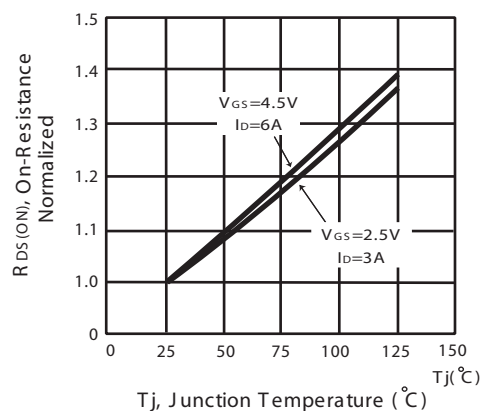

Figure 4. On-Resistance Variation with Drain Current and Temperature

# STS 2306E

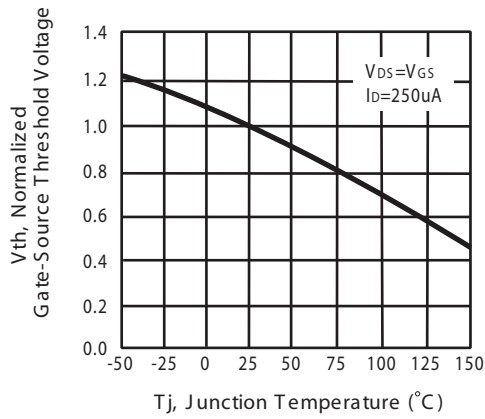

Figure 5. Gate Threshold Variation with Temperature

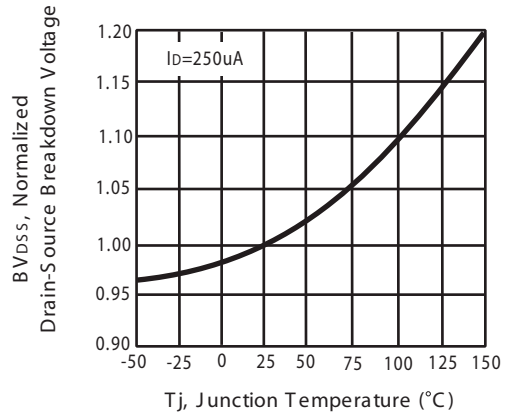

Figure 6. Breakdown Voltage Variation with Temperature

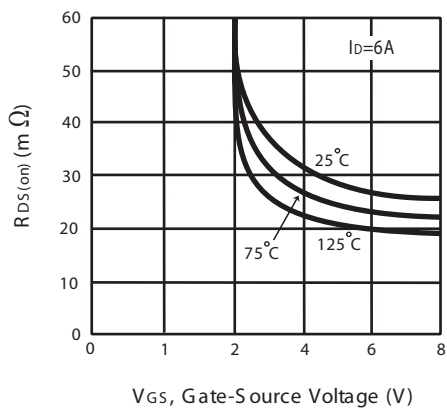

Figure 7. On-Resistance vs. Gate-Source Voltage

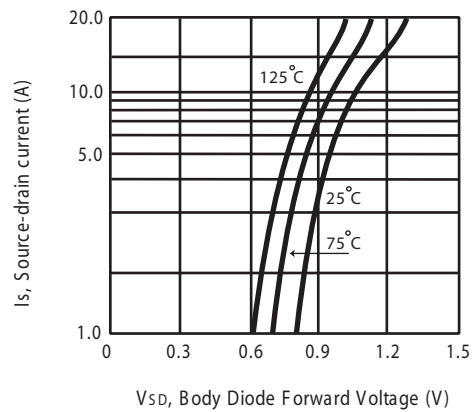

Figure 8. Body Diode Forward Voltage Variation with Source Current

# STS 2306E

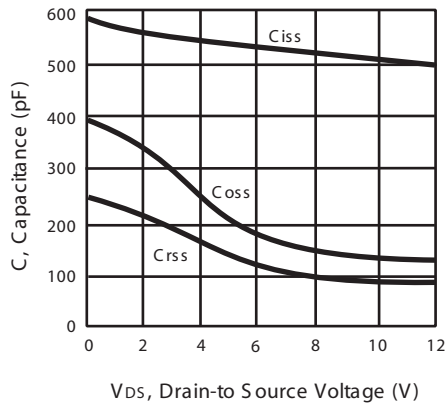

Figure 9. Capacitance

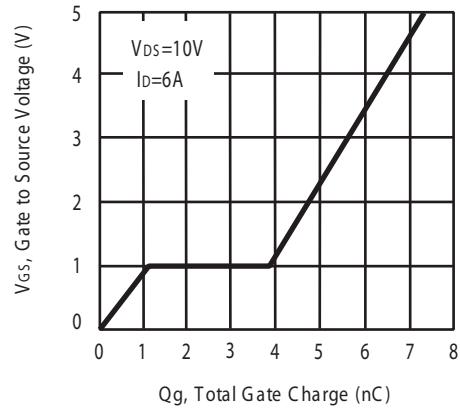

Figure 10. Gate Charge

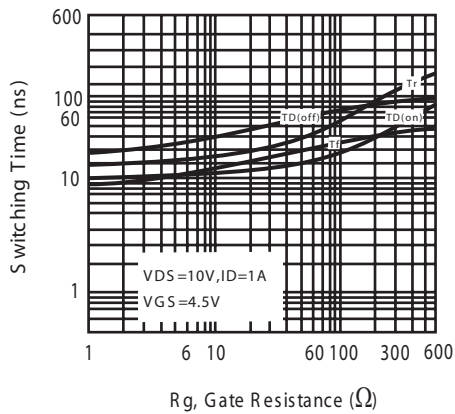

Figure 11. switching characteristics

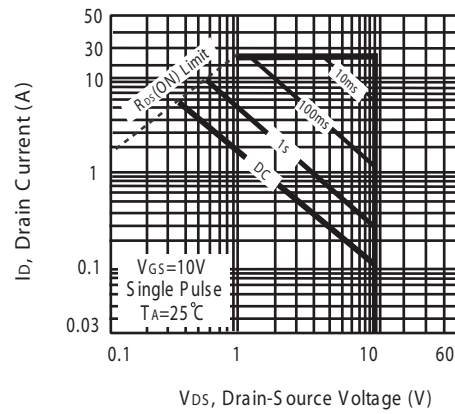
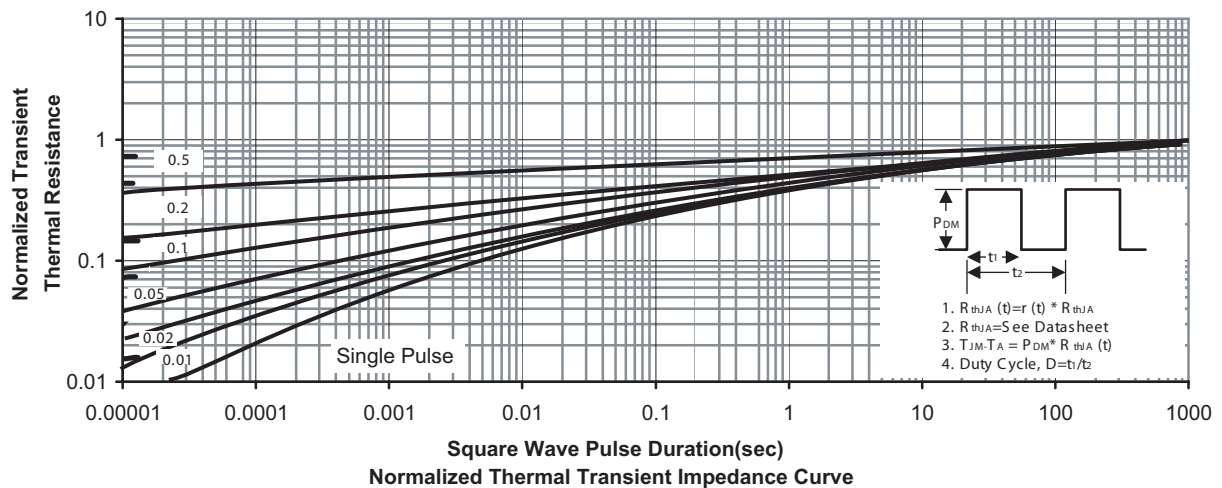

Figure 12. Maximum Safe Operating Area



# STS 2306E

## PACKAGE OUTLINE DIMENSIONS

### SOT-23

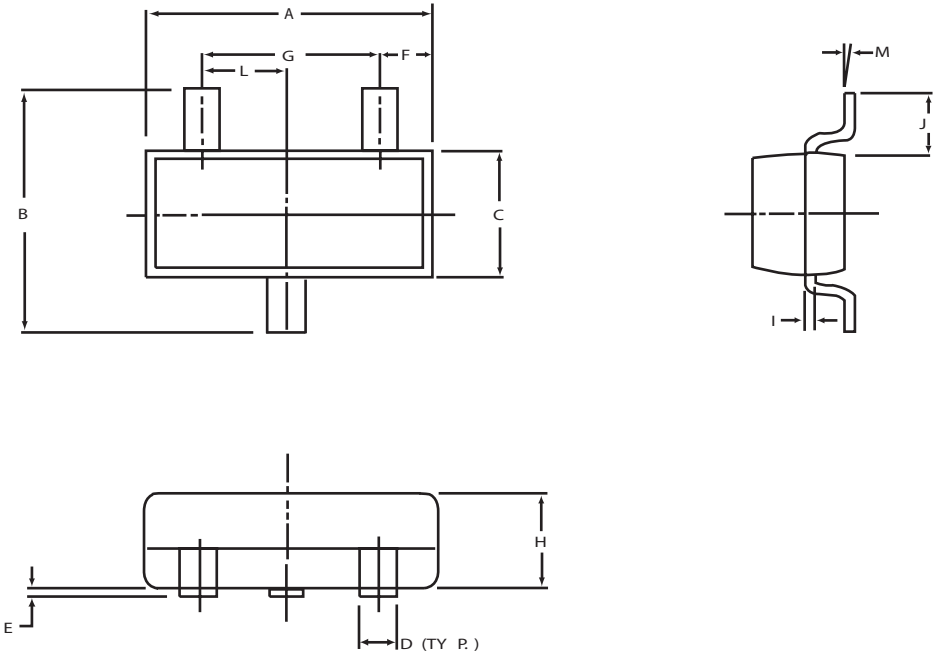

SYMBOLS	MILLIMETERS		INCHES	
	MIN	MAX	MIN	MAX
A	2.70	3.10	0.106	0.122
B	2.40	2.80	0.094	0.110
C	1.40	1.60	0.055	0.063
D	0.35	0.50	0.014	0.020
E	0	0.10	0	0.004
F	0.45	0.55	0.018	0.022
G	1.90 REF.		0.075 REF.	
H	1.00	1.30	0.039	0.051
I	0.10	0.20	0.004	0.008
J	0.40	-	0.016	-
L	0.45	1.15	0.033	0.045
M	0°	10°	0°	10°

# STS 2306E

## SOT-23 Tape and Reel Data

### SOT-23 Carrier Tape

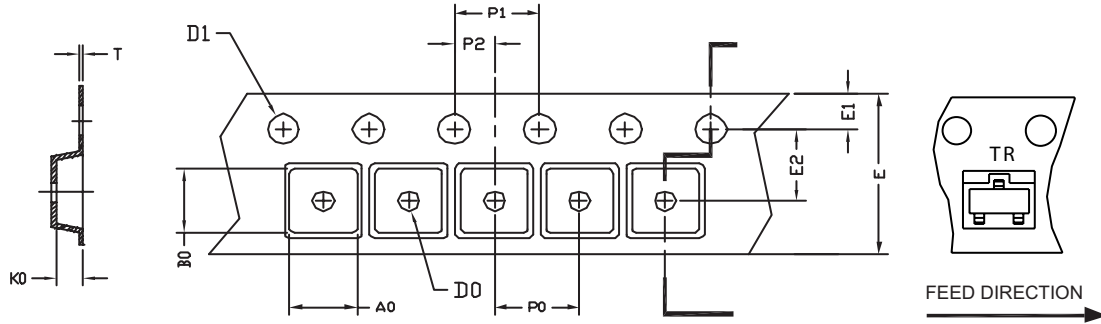

UNIT:mm

PACKAGE	A0	B0	K0	D0	D1	E	E1	E2	P0	P1	P2	T
SOT-23	3.20 $\pm 0.10$	3.00 $\pm 0.10$	1.33 $\pm 0.10$	$\phi$ 1.00 $+0.25$	$\phi$ 1.50 $+0.10$	8.00 $+0.30$ $-0.10$	1.75 $\pm 0.10$	3.50 $\pm 0.05$	4.00 $\pm 0.10$	4.00 $\pm 0.10$	2.00 $\pm 0.05$	0.20 $\pm 0.02$

### SOT-23 Reel I

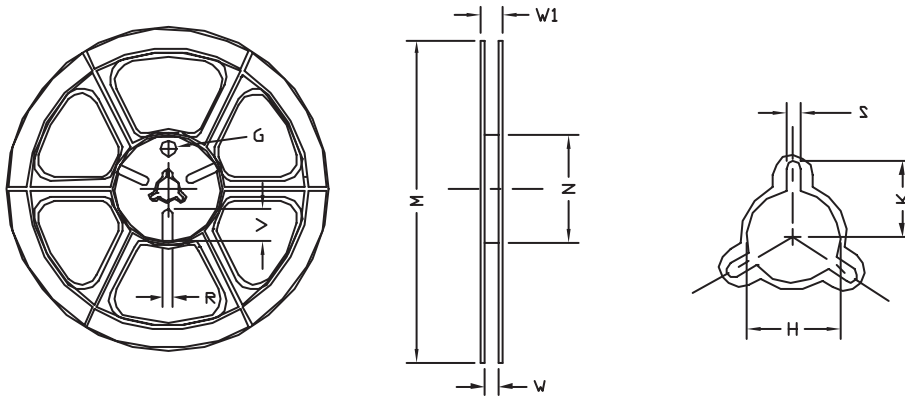

UNIT:mm

TAPE SIZE	REEL SIZE	M	N	W	W1	H	K	S	G	R	V
8mm	$\phi$ 178	$\phi$ 178 $\pm 1$	$\phi$ 60 $\pm 1$	9.00 $\pm 0.5$	12.00 $\pm 0.5$	$\phi$ 13.5 $\pm 0.5$	10.5	2.00 $\pm 0.5$	$\phi$ 10.0	5.00	18.00