

Fast Switching Diodes

BAS21SH

Features

- Fast switching speed
- Low forward voltage drop
- Pb-free lead plating package

Mechanical Data

- Case: Molded plastic, JEDEC SOD-123.
- Terminals: Pure tin plated, solderable per MIL-STD-202 method 208
- Polarity: Indicated by cathode band.
- Weight: 0.01 gram approximately

Maximum Ratings and Electrical Characteristics

(Rating at 25°C ambient temperature unless otherwise specified.)

Parameter	Symbol	Type	Units
Non-repetitive peak reverse voltage	V_{RM}	250	V
Repetitive peak reverse voltage	V_{RRM}	250	
Working peak reverse voltage	V_{RWM}	250	
RMS voltage	V_{RMS}	141	
DC blocking voltage	V_R	250	
Forward continuous current	I_{FM}	400	mA
Average rectified output current	I_O	200	
Peak forward surge current @ t=1ms t=1s	I_{FSM}	2.5	A
		0.5	
Repetitive peak forward current	I_{FRM}	625	mA
Power dissipation	P_D	500	mW
Thermal resistance, Junction to ambient	$R_{\theta JA}$	250	°C/W
Operating and storage temperature range	T_J, T_{STG}	-65 ~ +150	°C

Ordering Information

Device	Package	Shipping	Marking
BAS21SH	SOD-123 (Pb-free lead plating package)	3000 pcs / Tape & Reel	T3



Electrical Characteristics @ $T_A=25^\circ\text{C}$ unless otherwise specified

Parameters	Symbol	Conditions	Min	Typ.	Max	Unit
Forward voltage	V_F	$I_F=100\text{mA}$ $I_F=200\text{mA}$	-	-	1 1.25	V
Reverse current	I_R	$V_R=200\text{V}$	-	-	100	nA
Junction Capacitance	C_J	$V_R=0\text{V}$, $f=1\text{MHz}$	-	-	5	pF
Reverse recovery time	t_{rr}	$I_F=I_R=30\text{mA}$, $I_{rr}=0.1 \times I_R$, $R_L=100\ \Omega$	-	-	50	ns

Typical Characteristics

Forward Current vs Forward Voltage

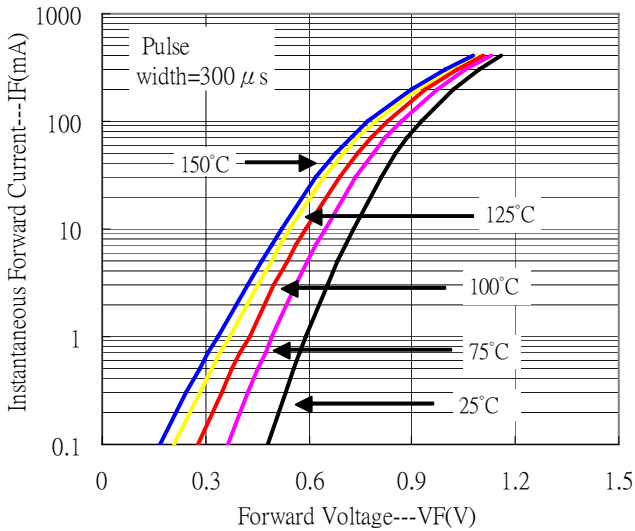

Reverse Leakage Current vs Reverse Voltage

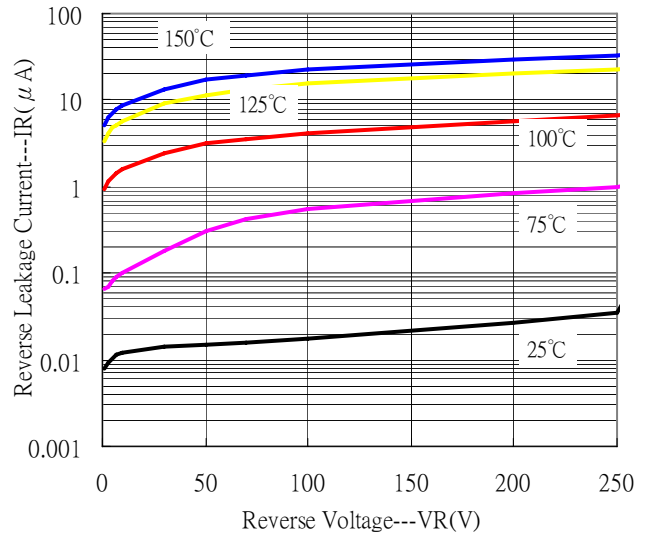

Junction Capacitance vs Reverse Voltage

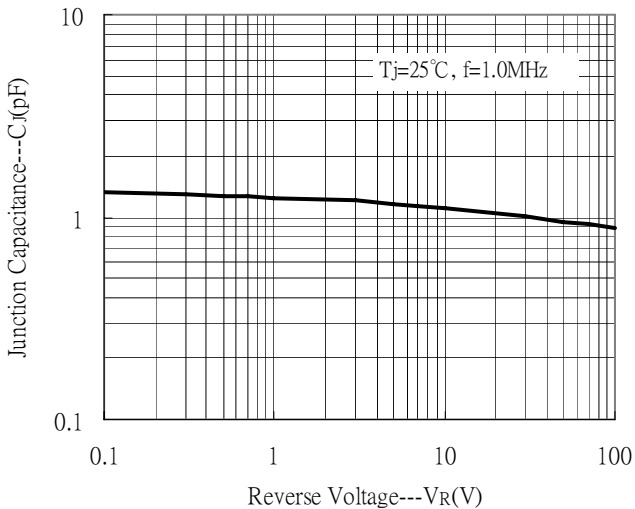

Power Derating Curve

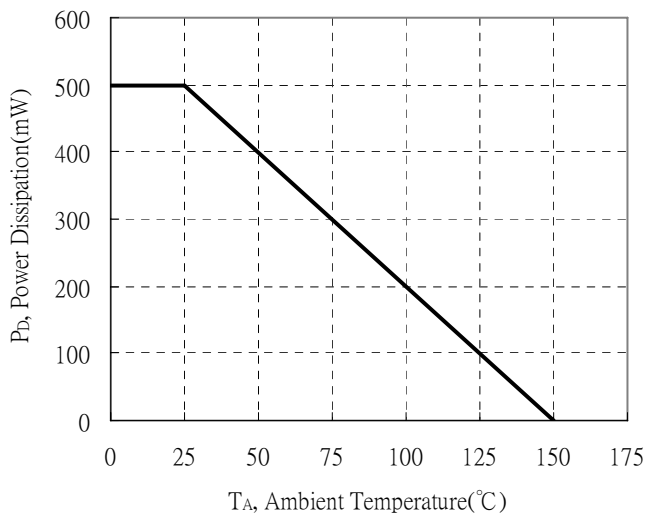

Reel Dimension

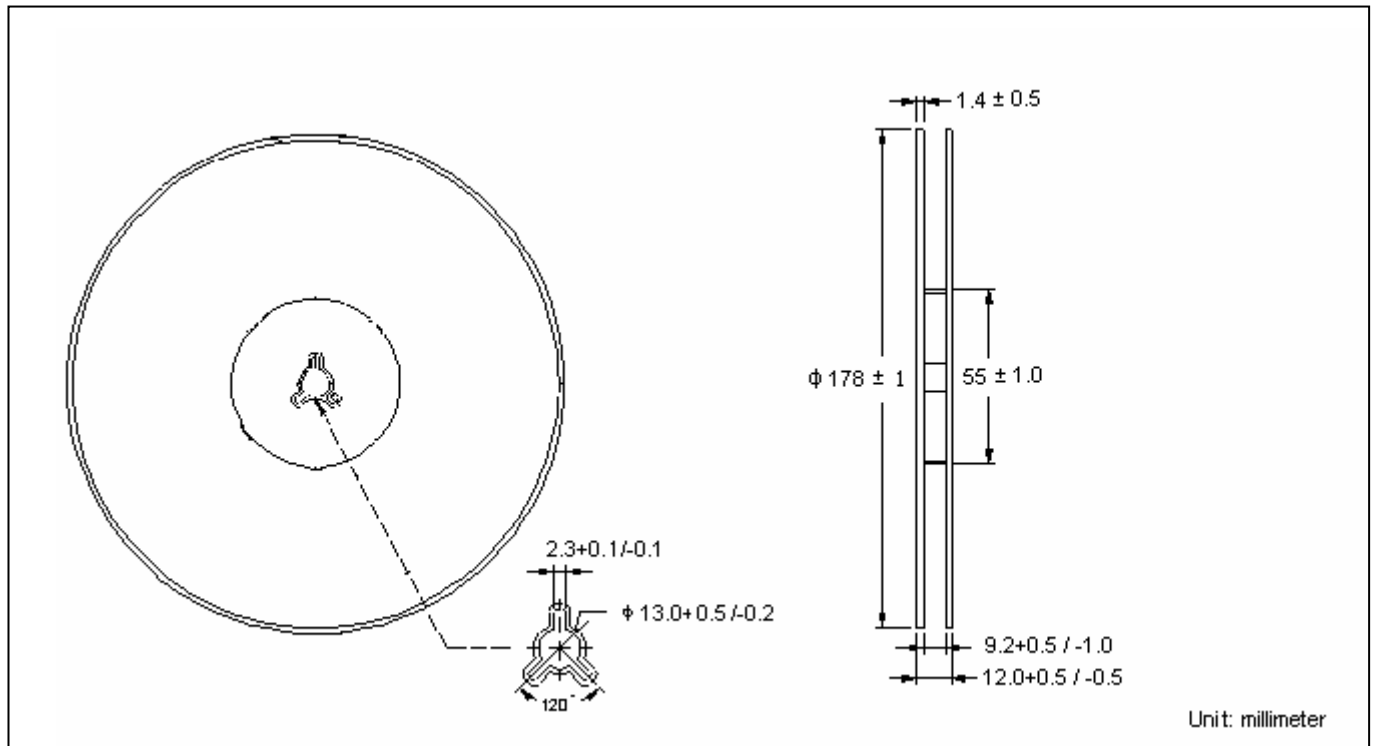

Carrier Tape Dimension

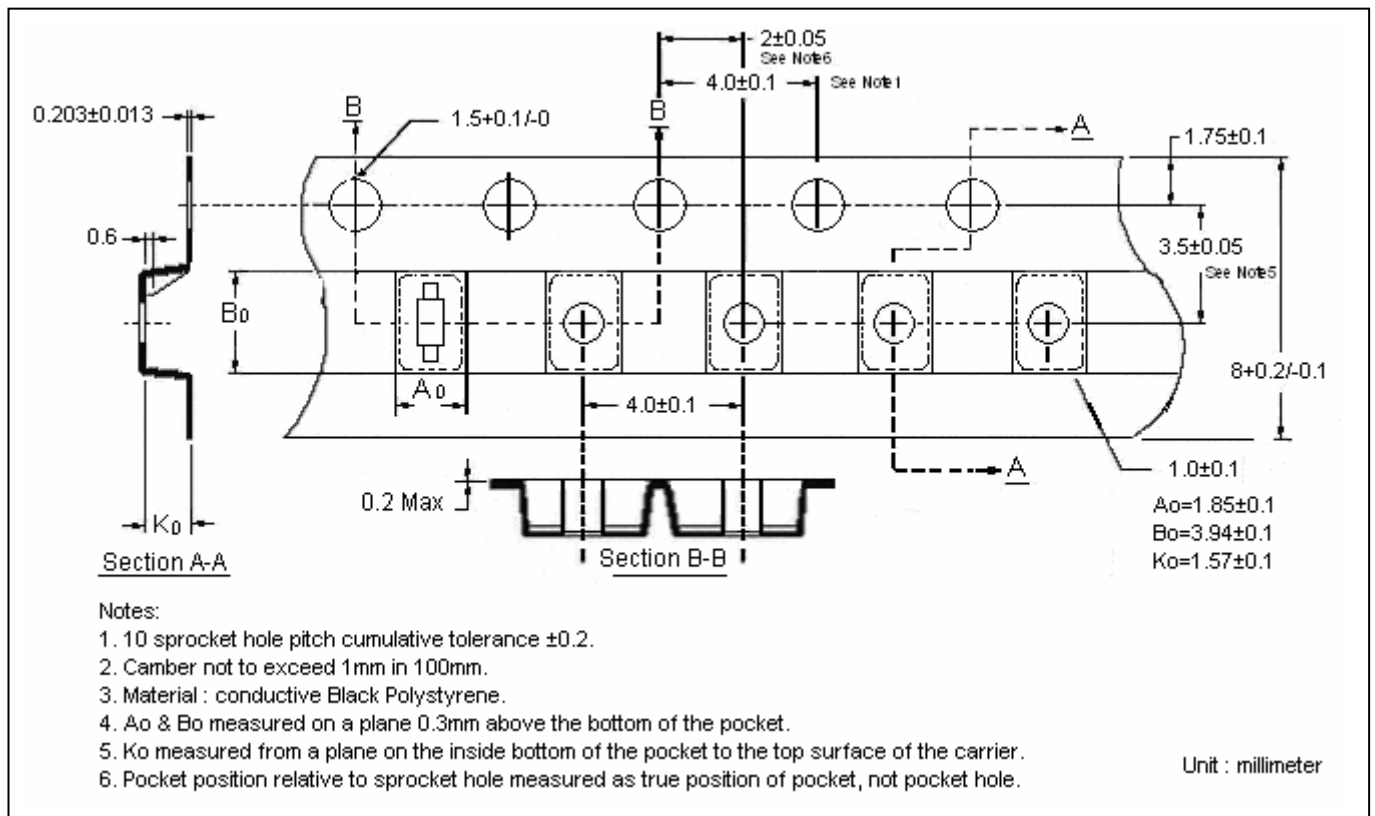

Notes:

1. 10 sprocket hole pitch cumulative tolerance ± 0.2 .
2. Camber not to exceed 1mm in 100mm.
3. Material : conductive Black Polystyrene.
4. A_o & B_o measured on a plane 0.3mm above the bottom of the pocket.
5. K_o measured from a plane on the inside bottom of the pocket to the top surface of the carrier.
6. Pocket position relative to sprocket hole measured as true position of pocket, not pocket hole.

Recommended wave soldering condition

Product	Peak Temperature	Soldering Time
Pb-free devices	260 +0/-5 °C	5 +1/-1 seconds

Recommended temperature profile for IR reflow

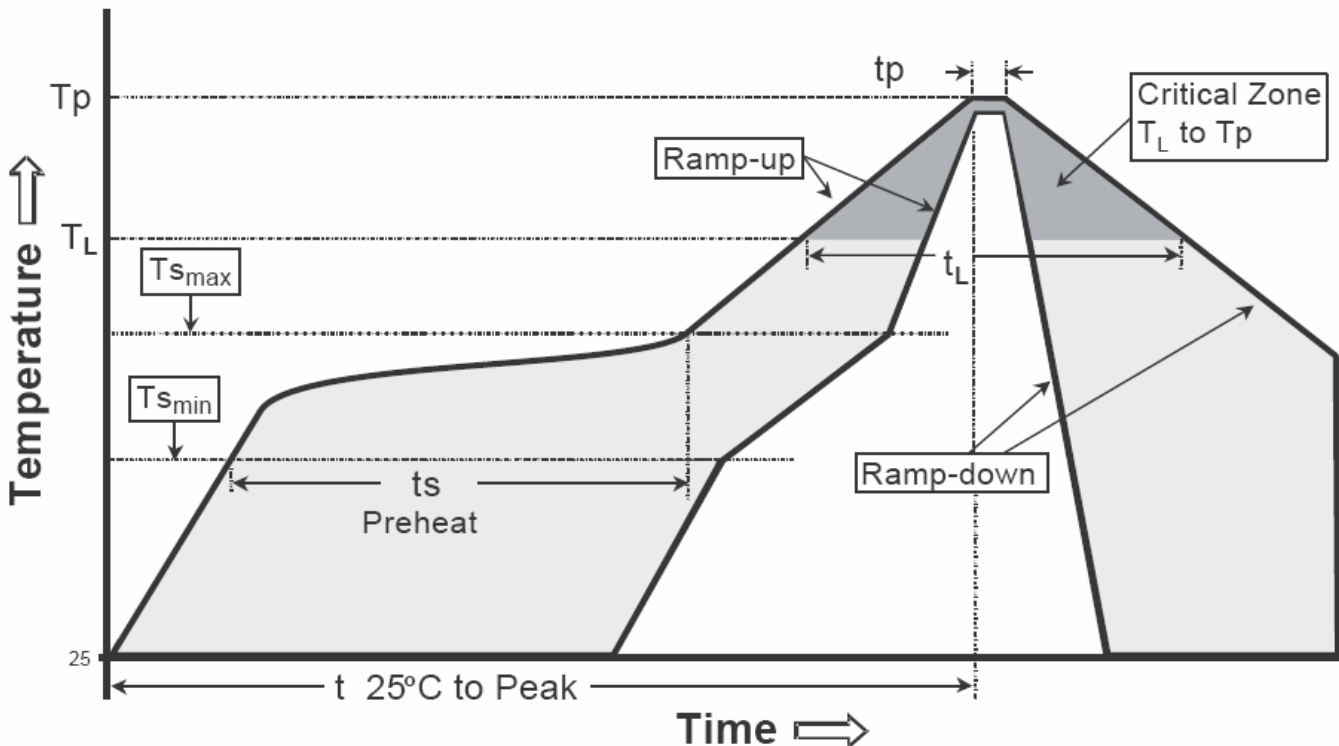

Profile feature	Sn-Pb eutectic Assembly	Pb-free Assembly
Average ramp-up rate (Tsmax to Tp)	3°C/second max.	3°C/second max.
Preheat		
-Temperature Min(Ts min)	100°C	150°C
-Temperature Max(Ts max)	150°C	200°C
-Time(ts min to ts max)	60-120 seconds	60-180 seconds
Time maintained above:		
-Temperature (TL)	183°C	217°C
- Time (tL)	60-150 seconds	60-150 seconds
Peak Temperature(TP)	240 +0/-5 °C	260 +0/-5 °C
Time within 5°C of actual peak temperature(tp)	10-30 seconds	20-40 seconds
Ramp down rate	6°C/second max.	6°C/second max.
Time 25 °C to peak temperature	6 minutes max.	8 minutes max.

Note : All temperatures refer to topside of the package, measured on the package body surface.

SOD-123 Dimension

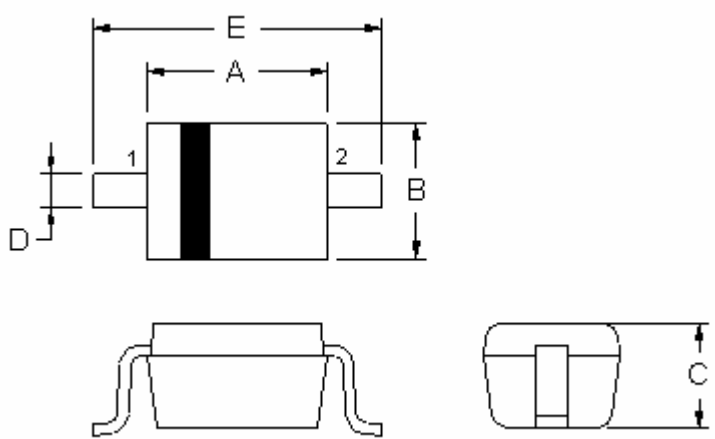

2-Lead SOD-123 Plastic
 Surface Mounted Package
 CYStek Package Code: SH

Style: Pin 1.Cathode 2.Anode

DIM	Inches		Millimeters		DIM	Inches		Millimeters	
	Min.	Max.	Min.	Max.		Min.	Max.	Min.	Max.
A	0.102	0.110	2.600	2.800	D	0.018	0.026	0.450	0.650
B	0.059	0.067	1.500	1.700	E	0.140	0.152	3.550	3.850
C	0.041	0.049	1.050	1.250					

Notes: 1.Controlling dimension : millimeters.
 2.Lead thickness specified per L/F drawing with solder plating.
 3.If there is any question with packing specification or packing method, please contact your local CYStek sales office.

Material:

- Lead: Pure tin plated.
- Mold Compound: Epoxy resin family, flammability solid burning class: UL94V-0.

Important Notice:

- All rights are reserved. Reproduction in whole or in part is prohibited without the prior written approval of CYStek.
- CYStek reserves the right to make changes to its products without notice.
- CYStek **semiconductor products are not warranted to be suitable for use in Life-Support Applications, or systems.**
- CYStek assumes no liability for any consequence of customer product design, infringement of patents, or application assistance.