

General Purpose NPN / PNP Epitaxial Planar Transistors (dual transistors)

HBNPZ1NS6R

Features

- Mounting possible with SOT-323 automatic mounting machines.
- Transistor elements are independent, eliminating interference.
- Mounting cost and area can be cut in half.
- Pb-free package.

Equivalent Circuit

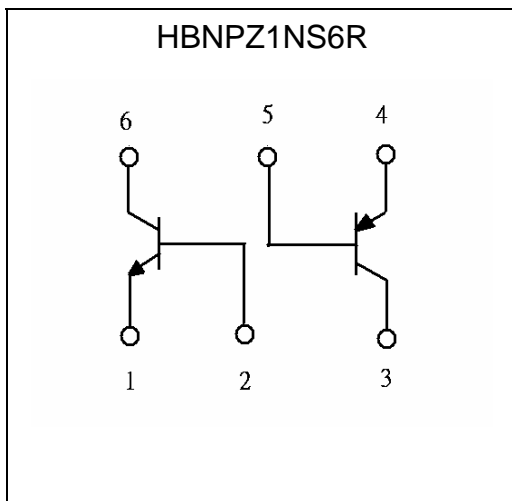

Outline

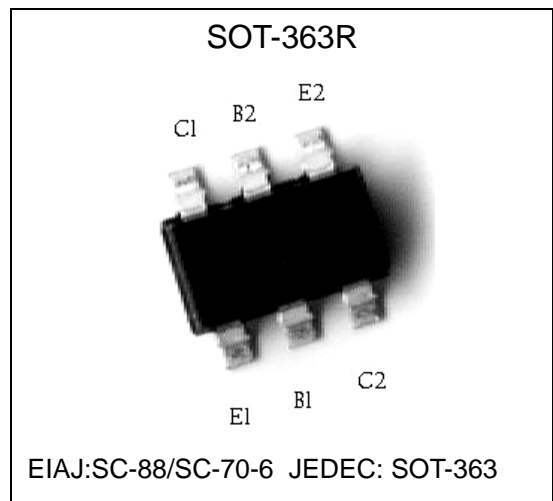

Absolute Maximum Ratings (Ta=25°C)

Parameter	Symbol	Limits		Unit
		TR1 (NPN)	TR2 (PNP)	
Collector-Base Voltage	V _{CB0}	50	-50	V
Collector-Emitter Voltage	V _{CE0}	45	-45	V
Emitter-Base Voltage	V _{EBO}	6	-5	V
Collector Current	I _C	150	-150	mA
Power Dissipation	P _d	200(total) *1		mW
Junction Temperature	T _j	150		°C
Storage Temperature	T _{stg}	-55~+150		°C

Note: *1 150mW per element must not be exceeded.

**Characteristics** (Ta=25°C)**• TR1 (NPN)**

Symbol	Min.	Typ.	Max.	Unit	Test Conditions
BV _{CBO}	50	-	-	V	I _C =100μA
BV _{CEO}	45	-	-	V	I _C =1mA
BV _{EBO}	6	-	-	V	I _E =50μA
I _{CBO}	-	-	15	nA	V _{CB} =30V
I _{EBO}	-	-	100	nA	V _{EB} =5V
*V _{CE(sat)}	-	0.2	0.4	V	I _C =50mA, I _B =5mA
*h _{FE}	200	-	600		V _{CE} =6V, I _C =1mA
f _T	80	180	-	MHz	V _{CE} =12V, I _C =2mA, f=100MHz
Cob	-	2	3.5	pF	V _{CB} =12V, f=1MHz

*Pulse Test: Pulse Width ≤380μs, Duty Cycle≤2%

• TR2 (PNP)

Symbol	Min.	Typ.	Max.	Unit	Test Conditions
BV _{CBO}	-50	-	-	V	I _C =-50μA
BV _{CEO}	-45	-	-	V	I _C =-1mA
BV _{EBO}	-5	-	-	V	I _E =-50μA
I _{CBO}	-	-	-15	nA	V _{CB} =-30V
I _{EBO}	-	-	-100	nA	V _{EB} =-4V
*V _{CE(sat)}	-	-0.25	-0.5	V	I _C =-50mA, I _B =-5mA
*h _{FE}	200	-	600		V _{CE} =-6V, I _C =-1mA
f _T	60	140	-	MHz	V _{CE} =-12V, I _C =-2mA, f=100MHz
Cob	-	4	5	pF	V _{CB} =-12V, f=1MHz

*Pulse Test: Pulse Width ≤380μs, Duty Cycle≤2%

Characteristic curves

• **TR1 (NPN)**

Current Gain vs Collector Current

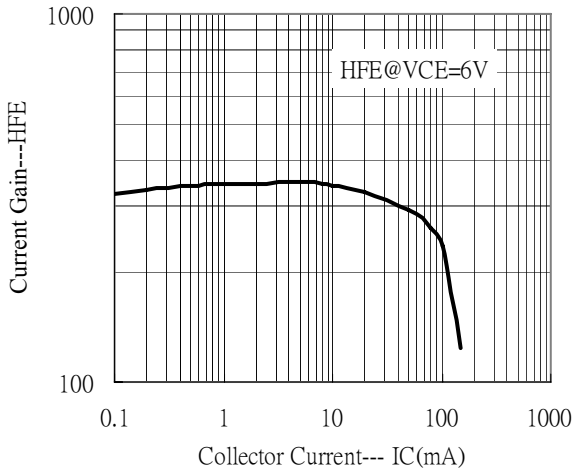

Saturation Voltage vs Collector Current

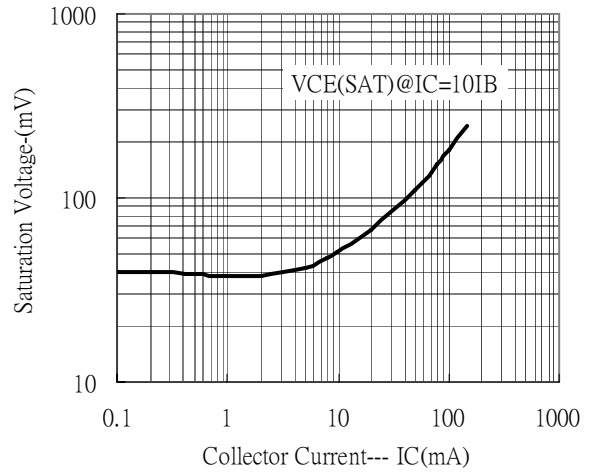

Saturation Voltage vs Collector Current

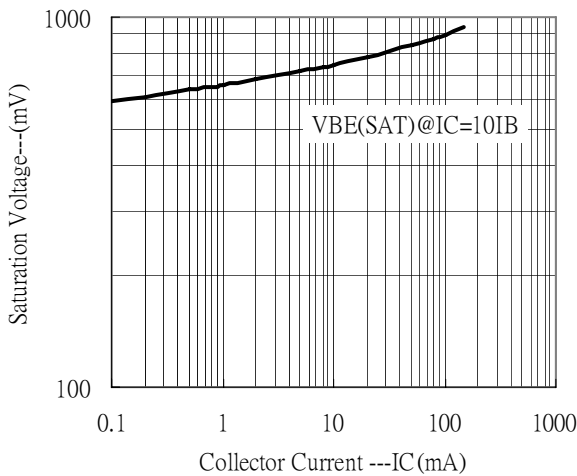

Cutoff Frequency vs Collector Current

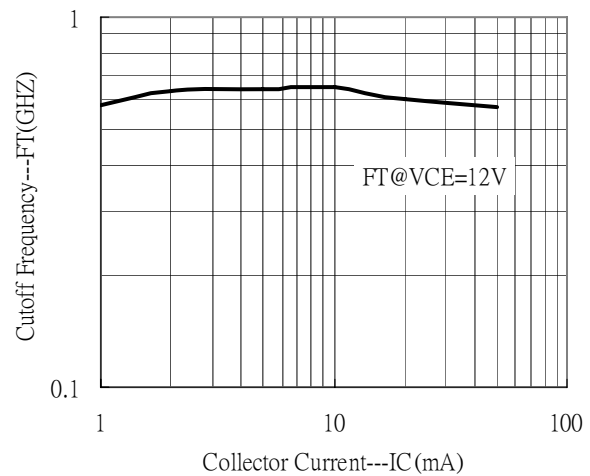



• TR2 (PNP)

Current Gain vs Collector Current

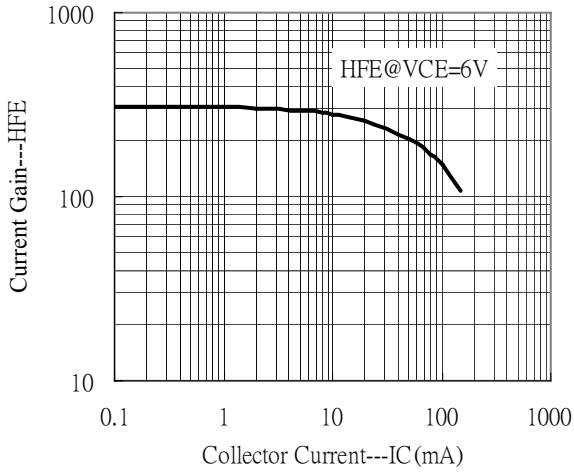

Saturation Voltage vs Collector Current

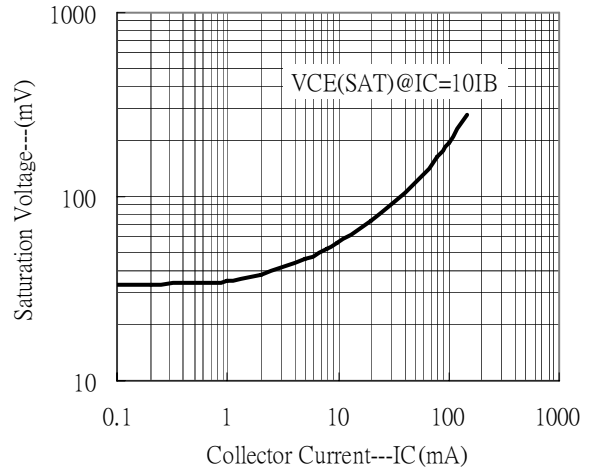

Saturation Voltage vs Collector Current

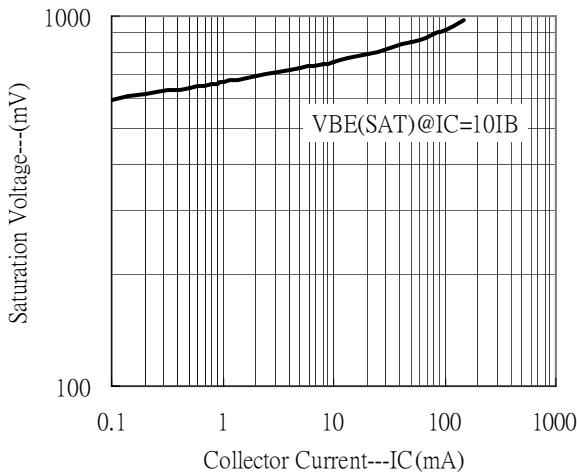

Cutoff Frequency vs Collector Current

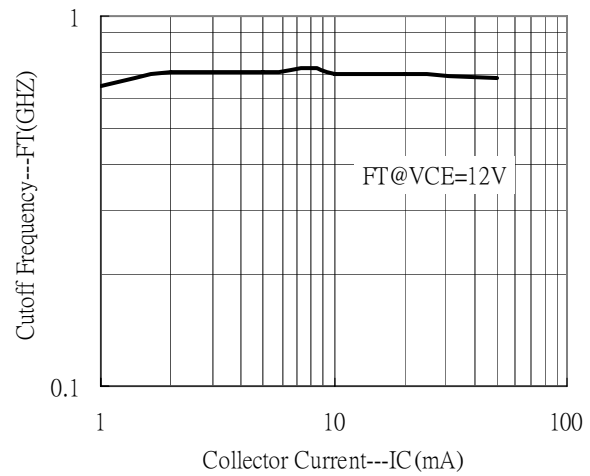

Power Derating Curves

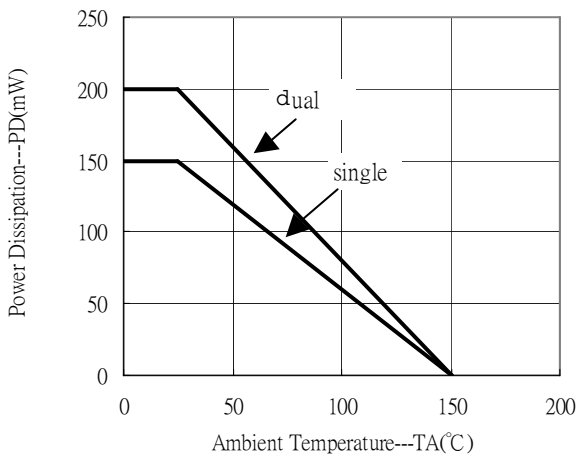

Reel Dimension

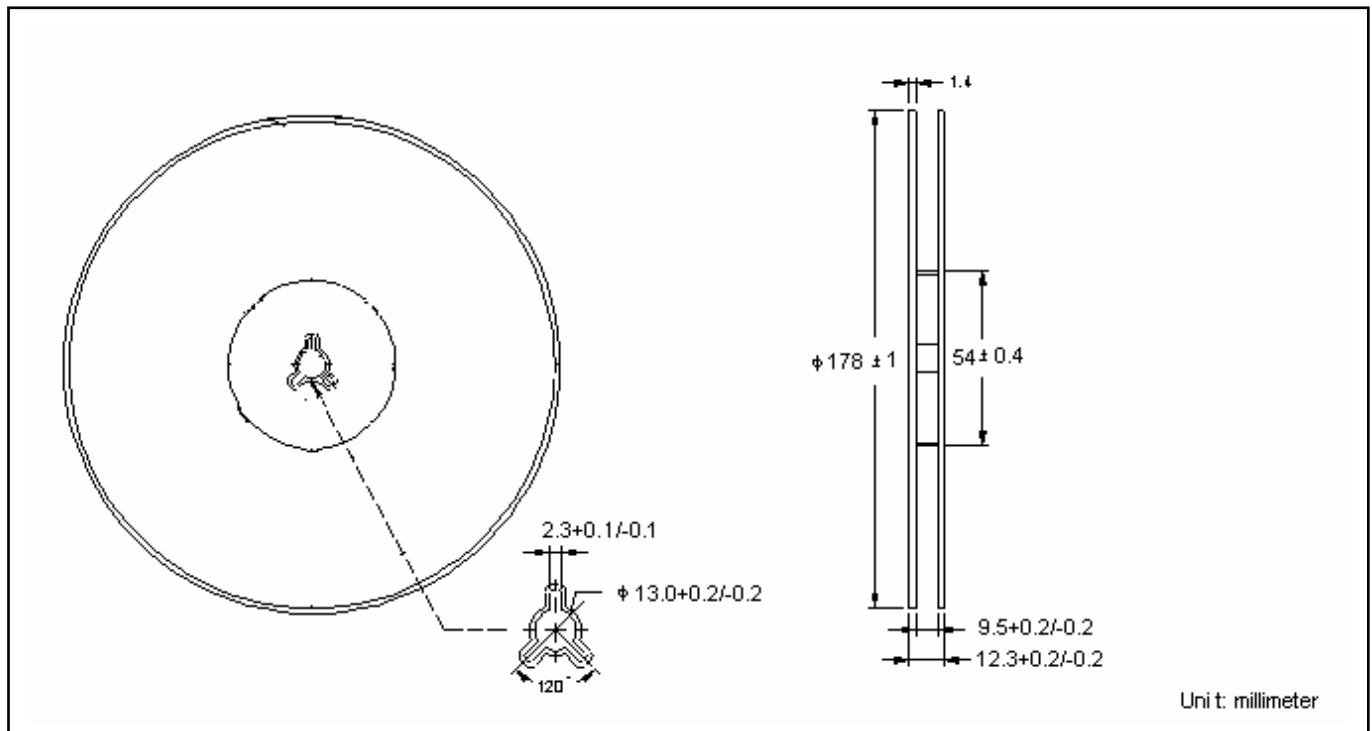

Carrier Tape Dimension

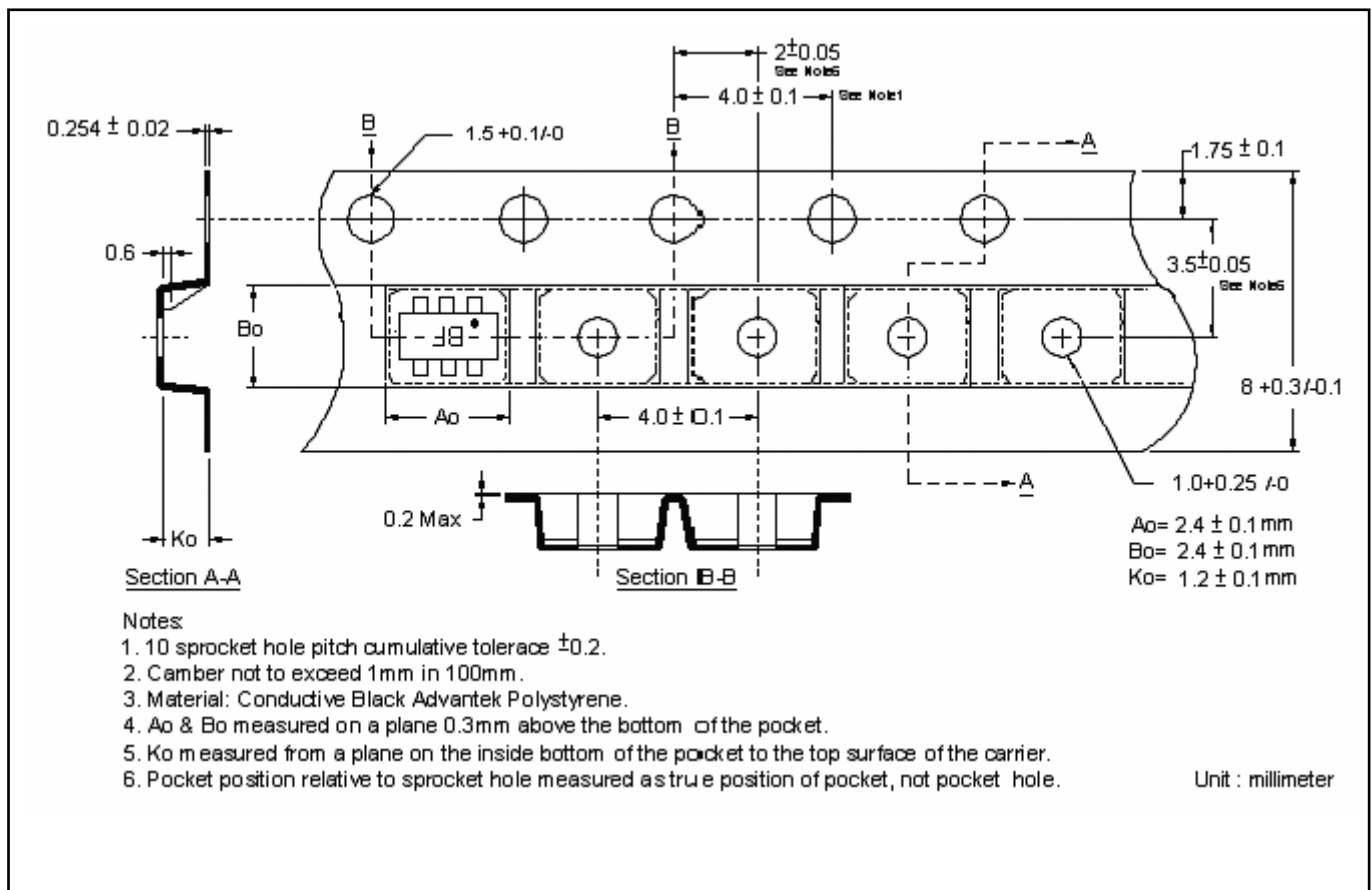

SOT-363 Dimension

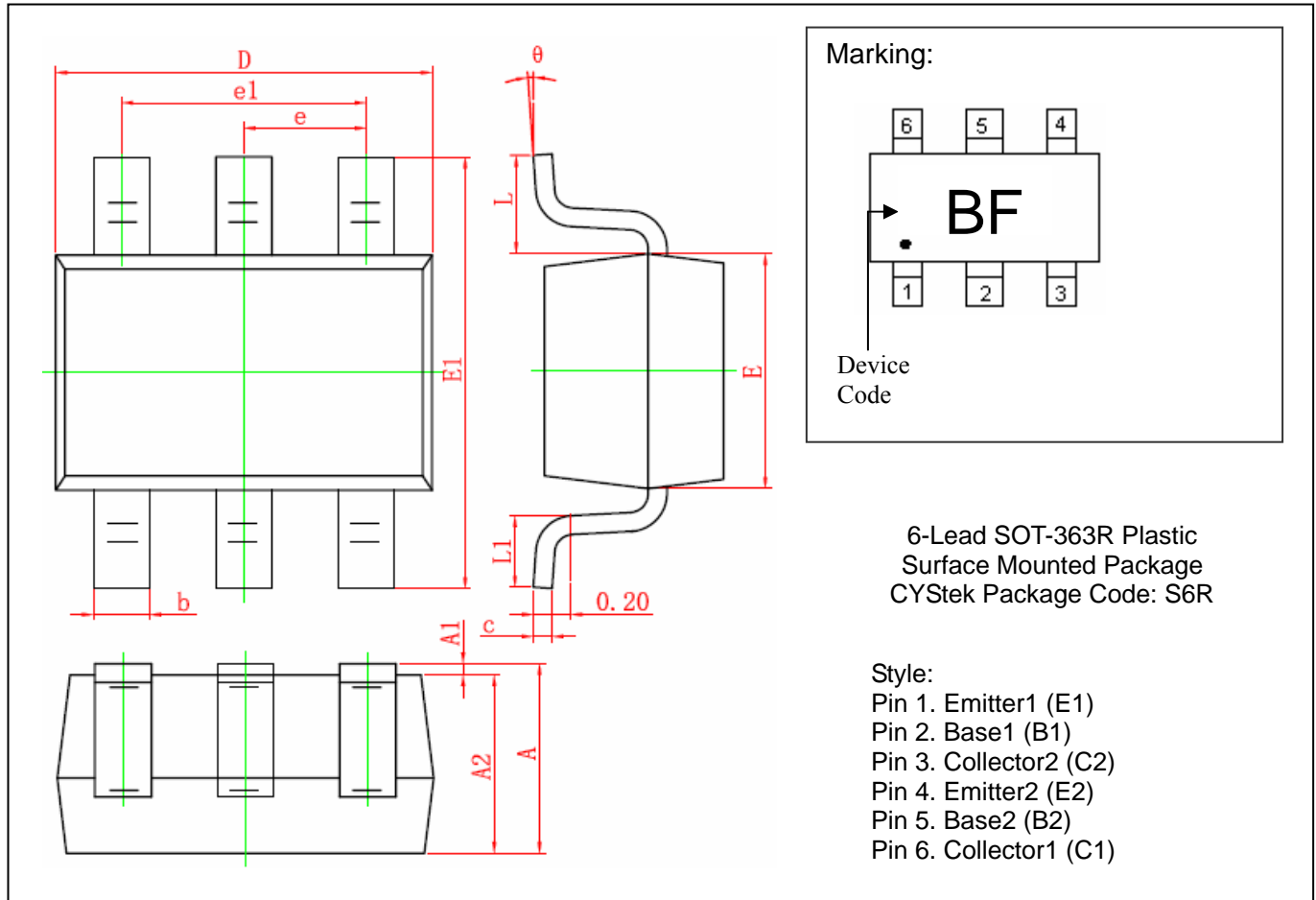

DIM	Millimeters		Inches		DIM	Millimeters		Inches	
	Min.	Max.	Min.	Max.		Min.	Max.	Min.	Max.
A	0.900	1.100	0.035	0.043	E1	2.150	2.450	0.085	0.096
A1	0.000	0.100	0.000	0.004	e	0.650 TYP		0.026 TYP	
A2	0.900	1.000	0.035	0.039	e1	1.200	1.400	0.047	0.055
b	0.150	0.350	0.006	0.014	L	0.525 REF		0.021	REF
c	0.080	0.150	0.003	0.006	L1	0.260	0.460	0.010	0.018
D	2.000	2.200	0.079	0.087	theta	0°	8°	0°	8°
E	1.150	1.350	0.045	0.053					

Notes : 1.Controlling dimension : millimeters.
 2.Maximum lead thickness includes lead finish thickness, and minimum lead thickness is the minimum thickness of base material.
 3.If there is any question with packing specification or packing method, please contact your local CYStek sales office.

Material :

- Lead : Pure tin plated.
- Mold Compound : Epoxy resin family, flammability solid burning class:UL94V-0.

Important Notice:

- All rights are reserved. Reproduction in whole or in part is prohibited without the prior written approval of CYStek.
- CYStek reserves the right to make changes to its products without notice.
- CYStek **semiconductor products are not warranted to be suitable for use in Life-Support Applications, or systems.**
- CYStek assumes no liability for any consequence of customer product design, infringement of patents, or application assistance.