

## Thyristor Surge Suppressors (TSS)

P0642SA – P6002SA Series - DO-214AA(SMB)

@10/700 $\mu$ S, 2KV

### Description

P0642SA-P6002SA Series are very low capacitance devices designed to protect broadband equipment such as VoIP, DSL modems and DSLAMs from damaging over-voltage transients. This series provides a surface mount solution that enables equipment to comply with global regulatory standards, while limiting the impact to broadband signals.

### Features and Benefits

- u Low voltage overshoot
- u Low on-state voltage
- u Does not degrade with use
- u Fails short circuit when surged in excess of ratings
- u Low distortion
- u 40% lower capacitance than comparable product

### Applicable Global Standards

- u TIA-968-A
- u ITU K.20/21 Enhanced level
- u ITU K.20/21 Basic Level
- u GR 1089 Inter building
- u IEC 6100-4-5
- u YD/T 1082
- u YD/T 993
- u YD/T 950



### Schematic Symbol

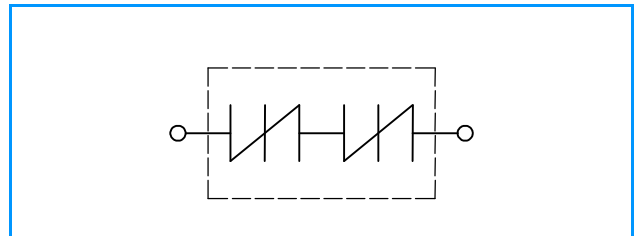

### Electrical Parameters

Parameter	Definition
$I_S$	<b>Switching Current</b> - maximum current required to switch to on state
$I_{DRM}$	<b>Leakage Current</b> - maximum peak off-state current measured at $V_{DRM}$
$I_H$	<b>Holding Current</b> - minimum current required to maintain on state
$I_T$	<b>On-state Current</b> - maximum rated continuous on-state current
$V_S$	<b>Switching Voltage</b> - maximum voltage prior to switching to on stat
$V_{DRM}$	<b>Peak Off-state Voltage</b> - maximum voltage that can be applied while maintaining off state
$V_T$	<b>On-state Voltage</b> - maximum voltage measured at rated on-state current
$C_0$	<b>Off-state Capacitance</b> - typical capacitance measured in off state

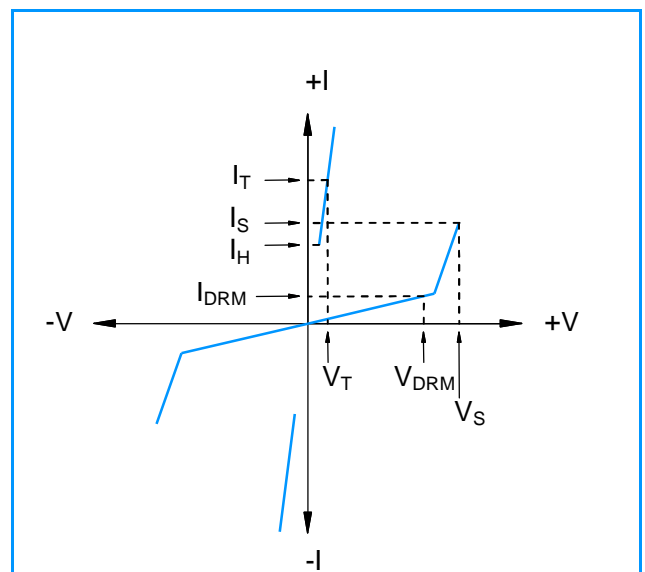

## Thyristor Surge Suppressors (TSS)

P0642SA – P6002SA Series - DO-214AA(SMB) @10/700 $\mu$ S, 2KV

### Electrical Characteristics

Part Number	Marking	$V_{DRM}$ @ $I_{DRM}=5\mu A$	$V_S$ @100V/ $\mu S$	$V_T$ @ $I_T=2.2A$	$I_S$	$I_T$	$I_H$	$C_0$ @1MHz	
		V min	V max	V max	mA max	A max	mA min	pF min	pF max
P0642SA	P06A	58	77	4	800	2.2	120	25	45
P0722SA	P07A	65	88	4	800	2.2	120	20	45
P0902SA	P09A	75	98	4	800	2.2	120	20	40
P1102SA	P11A	90	130	4	800	2.2	120	15	35
P1302SA	P13A	120	160	4	800	2.2	120	15	35
P1502SA	P15A	140	180	4	800	2.2	120	15	30
P1802SA	P18A	170	220	4	800	2.2	120	10	30
P2302SA	P23A	190	260	4	800	2.2	120	10	25
P2602SA	P26A	220	300	4	800	2.2	120	10	25
P3002SA	P30A	280	360	4	800	2.2	120	10	25
P3502SA	P35A	320	400	4	800	2.2	120	10	20
P4202SA	P42A	380	500	4	800	2.2	120	10	20
P4802SA	P48A	440	600	4	800	2.2	120	5	20
P6002SA	P60A	550	700	4	800	2.2	120	5	20

Notes:

- Absolute maximum ratings measured at  $T_A=25^\circ C$  (unless otherwise noted).
- Devices are bi-directional.

### Surge Ratings

Series	2/10 $\mu S^1$	8/20 $\mu S^1$	10/160 $\mu S^1$	10/560 $\mu S^1$	10/1000 $\mu S^1$	5/310 $\mu S^1$	$I_{TSM}$ 50/60 Hz	di/dt
	2/10 $\mu S^2$	1.2/50 $\mu S^2$	10/160 $\mu S^2$	10/560 $\mu S^2$	10/1000 $\mu S^2$	10/700 $\mu S^2$		
	A min	A min	A min	A min	A min	A min	A min	Amps/ $\mu s$ max
A	150	150	90	50	45	50	20	500

Notes:

- Current waveform in  $\mu s$
  - Voltage waveform in  $\mu s$
- Peak pulse current rating ( $I_{PP}$ ) is repetitive and guaranteed for the life of the product.
  - $I_{PP}$  ratings applicable over temperature range of  $-40^\circ C$  to  $+85^\circ C$
  - The device must initially be in thermal equilibrium with  $-40^\circ C < T_J < +150^\circ C$

### Thermal Considerations

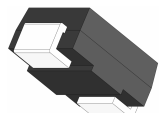
Package	Symbol	Parameter	Value	Unit
DO-214AA 	$T_J$	Operating Junction Temperature Range	- 40 to + 150	$^\circ C$
	$T_S$	Storage Temperature Range	- 40 to +150	$^\circ C$
	$R_{\theta JA}$	Thermal Resistance: Junction to Ambient	90	$^\circ C/W$

# Thyristor Surge Suppressors (TSS)

**P0642SA – P6002SA Series - DO-214AA(SMB) @10/700μS, 2KV**

## Characteristic Curves

**Figure 1 - V-I Characteristics**



**Figure 2 -  $t_r \times t_d$  Pulse Waveform**



**Figure 3 - Normalized  $V_S$  Change Versus Junction Temperature**

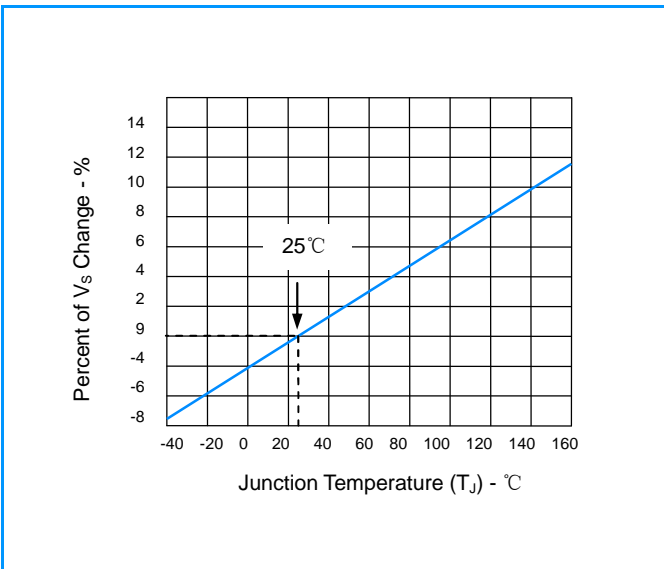

**Figure 4 - Normalized DC Holding Current Versus Case Temperature**



# Thyristor Surge Suppressors (TSS)

**P0642SA – P6002SA Series - DO-214AA(SMB)**
**@10/700 $\mu$ S, 2KV**

## Environmental Specifications

<b>High Temp Voltage Blocking</b>	80% Rated VDRM (VAC Peak ) +125°C or +150°C, Lead Material Copper Alloy High Temp Voltage Blocking 504 or 1008 hrs. MIL-STD-750 (Method 1040) JEDEC, JESD22-A-101
<b>Temp Cycling</b>	-65°C to +150°C, 15 min. dwell, 10 up to 100 cycles. MIL-STD-750 (Method 1051) EIA/JEDEC, JESD22-A104
<b>Biased Temp &amp; Humidity</b>	52 VDC (+85°C) 85%RH, 504 up to 1008 hrs. EIA/JEDEC, JESD22-A-101
<b>High Temp Storage</b>	+150°C 1008 hrs. MIL-STD-750 (Method 1031) JEDEC, JESD22-A-101
<b>Low Temp Storage</b>	-65°C, 1008 hrs.
<b>Thermal Shock</b>	0°C to +100°C, 5 min. dwell, 10 sec. transfer, Thermal Shock 10 cycles. MIL-STD-750 (Method 1056) JEDEC, JESD22-A-106
<b>Autoclave (Pressure Cooker Test)</b>	+121°C, 100%RH, 2atm, 24 up to 168 hrs. EIA/Cooker Test) JEDEC, JESD22-A-102
<b>Resistance to Solder Heat</b>	+260°C, 30 secs. MIL-STD-750 (Method 2031)
<b>Moisture Sensitivity Level</b>	85%RH, +85°C, 168 hrs., 3 reflow cycles Level (+260°C Peak). JEDEC-J-STD-020, Level 1

## Physical Specifications

<b>Lead Material</b>	Copper Alloy
<b>Terminal Finish</b>	100% Matte-Tin Plated
<b>Body Material</b>	UL recognized epoxy meeting flammability classification 94V-0

## Soldering Parameters

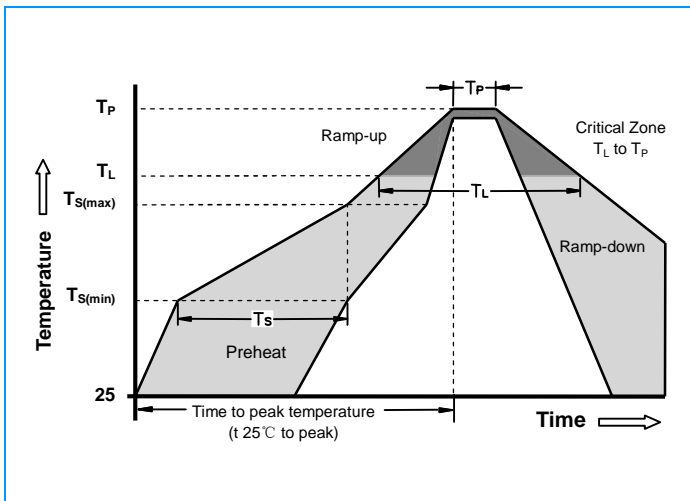

<b>Reflow Condition</b>		Lead-free assembly
<b>Pre Heat</b>	-Temperature Min ( $T_{s(min)}$ )	+150°C
	-Temperature Max ( $T_{s(max)}$ )	+200°C
	-Time (min to max) ( $t_s$ )	60 -180 Seconds
<b>Average ramp up rate ( Liquidus Temp <math>T_L</math>) to peak</b>		3°C/Second Max
<b><math>T_{s(max)}</math> to <math>T_L</math> - Ramp-up Rate</b>		3°C/Second Max
<b>Reflow</b>	- Temperature ( $T_L$ ) (Liquidus)	+217°C
	- Time (min to max) ( $t_s$ )	60 -150 Seconds
<b>Peak Temperature (<math>T_P</math>)</b>		260 +0/-5°C
<b>Time within 5°C of actual peak Temperature (<math>t_p</math>)</b>		30 Seconds Max
<b>Ramp-down Rate</b>		6°C/Second Max
<b>Time 25°C to peak Temperature (<math>T_P</math>)</b>		8 minutes Max
<b>Do not exceed</b>		+260°C

# Thyristor Surge Suppressors (TSS)

**P0642SA – P6002SA Series - DO-214AA(SMB) @10/700µS, 2KV**

## Part Numbering

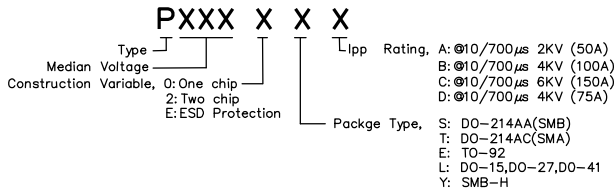

## Part Marking

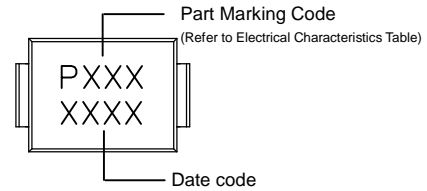

## Dimensions DO-214AA

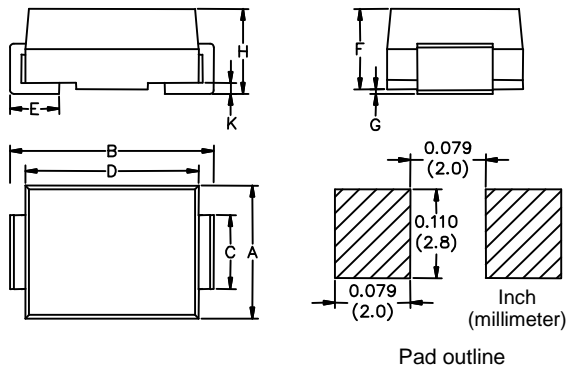

Dimensions	Inches		Millimeters	
	Min	Max	Min	Max
A	0.130	0.156	3.30	3.95
B	0.201	0.220	5.10	5.60
C	0.077	0.087	1.95	2.20
D	0.159	0.181	4.05	4.60
E	0.030	0.063	0.76	1.60
F	0.076	0.096	1.90	2.45
G	0.002	0.008	0.05	0.20
H	0.077	0.104	1.95	2.65
K	0.006	0.016	0.15	0.41

## Packaging

Part Number	Component Package	Quantity	Packaging Option	Packaging Specification
Pxxx2SA	DO-214AA	2500	Tape & Reel -12mm/13"tape	EIA -481 - D

## Tape and Reel Specifications

