



- Precision SAW Filter
- 13.3 x 6.5 mm Case
- Complies with Directive 2002/95/EC (RoHS) 

Maximum Rating

Rating	Value	Units
Input Power Level	+20	dBm
Operating Temperature	-40 to +85	°C
Storage Temperature in Tape and Reel	-40 to +85	°C
Suitable for Lead-free Soldering, Maximum Soldering Temperature	260 °C for 30 s	

SF2033A

**350.00 MHz
SAW Filter**

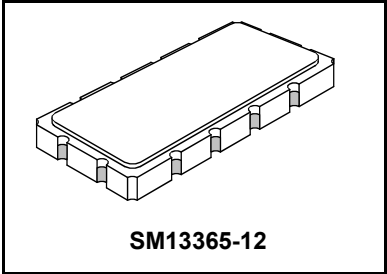

Electrical Characteristics

Characteristic	Sym	Notes	Min	Typ	Max	Units
Center Frequency	f_C		349.9	350.0	350.1	MHz
Insertion Loss	IL			13.5	14.5	dB
3 dB Bandwidth			2.60	2.65		MHz
20 dB Bandwidth				3.8	4.0	MHz
45 dB Bandwidth				4.4	6.0	MHz
Amplitude Ripple, $f_C \pm 0.85$ MHz				0.4	0.7	dB
Group Delay Ripple, $f_C \pm 1.1$ MHz				35	70	ns
Substrate Material			Quartz			
Temperature Coefficient of Frequency				$\Delta F/F = -[(T-T_0)/5.4]^2$		ppm/K

Case Style	SM13365-12 13.3 x 6.5 mm Nominal Footprint					
Lid Symbolization	SF2033A					
(YY=year, WW=week, S=shift, ##=sequence code) dot=pin 1 indicator	YYWWS##					
Standard Reel Quantity	Reel Size 7 Inch					500 Pieces/Reel
	Reel Size 13 Inch					2000 Pieces/Reel



CAUTION: Electrostatic Sensitive Device. Observe precautions for handling.

Notes:

1. US and International patents may apply.
2. RFM, stylized RFM logo, and RF Monolithics, Inc. are registered trademarks of RF Monolithics, Inc.

27 May 2004 07:54:44

CH1 S11 1 U FS
 1: 45 . 654 n 19 . 053 n 8 . 6638 nH
 350 . 000 000 MHz

CH3 S22 1 U FS
 1: 83 . 516 n -6 . 3594 n 71 . 505 pF
 350 . 000 000 MHz

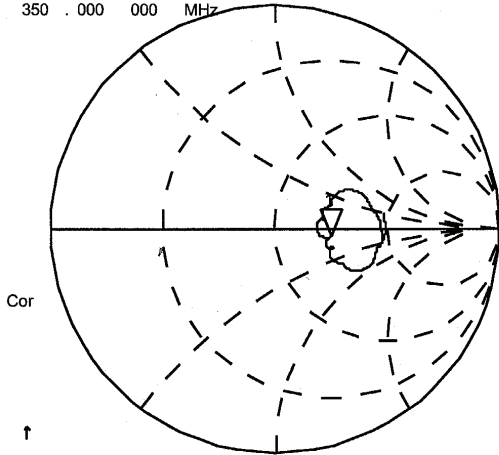
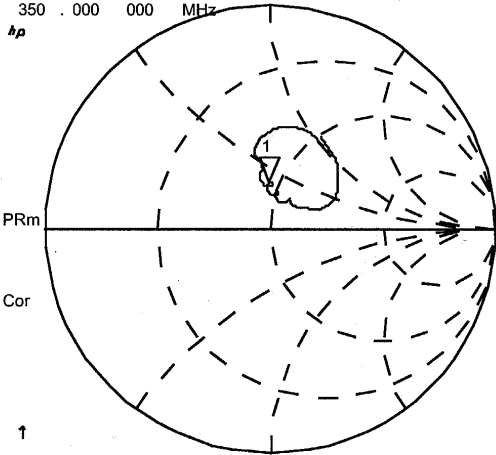

CENTR 350 . 000 MHz SPAN 6 . 200 MHz

CENTR 350 . 000 MHz SPAN 6 . 200 MHz

CH2 S21 LOG 10 dB/ REF -12.6 dB 1: 0.0000 dB 0.000 000 MHz

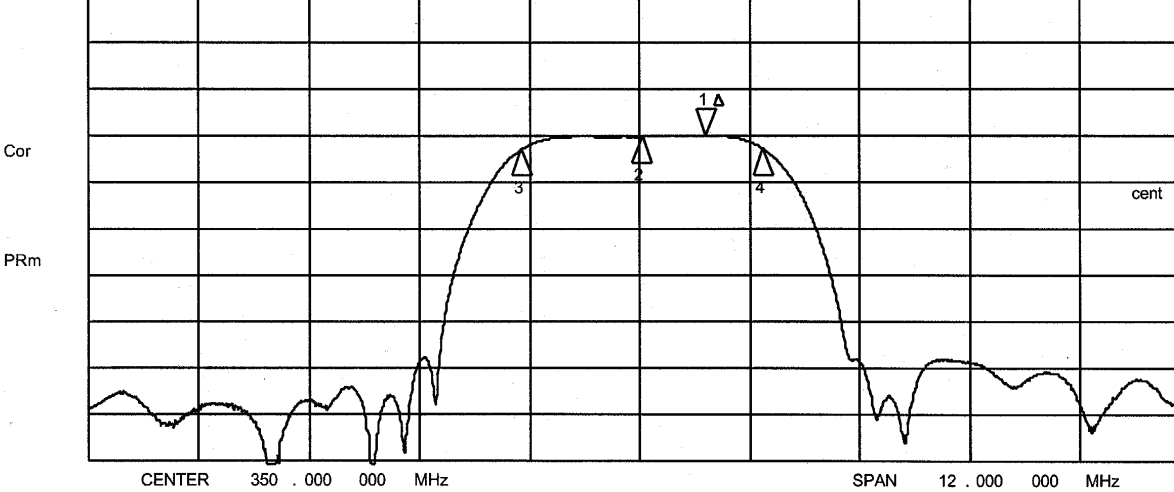

CH2 Markers
 Max Δ REF=1
 BW: 2.625488 MHz
 cent: 350.035472 MHz
 Q: 133.32
 loss: -12.507 dB

27 May 2004 07:55:33

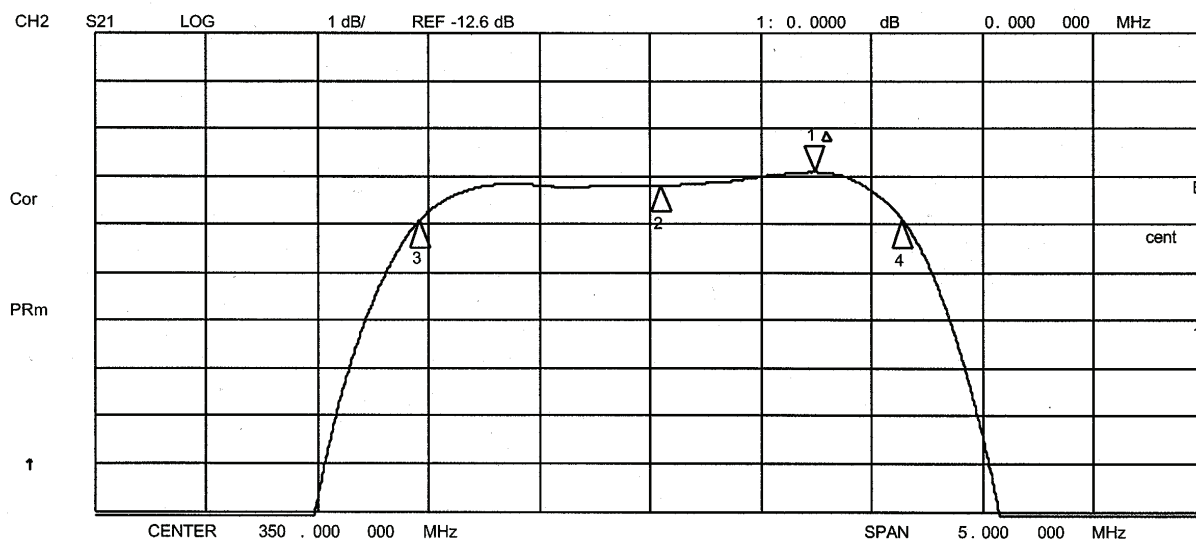
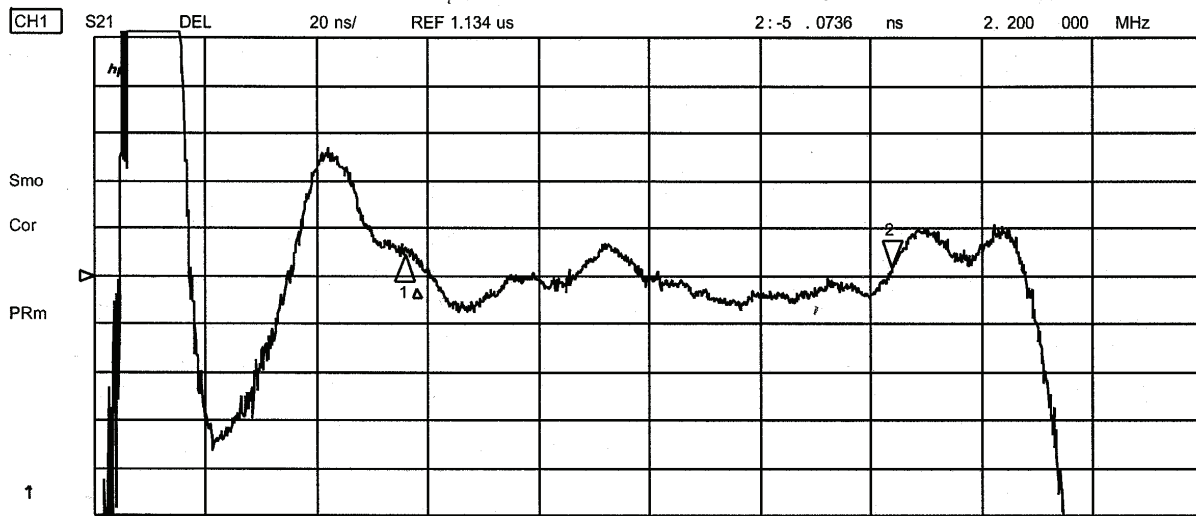

Matching Circuit

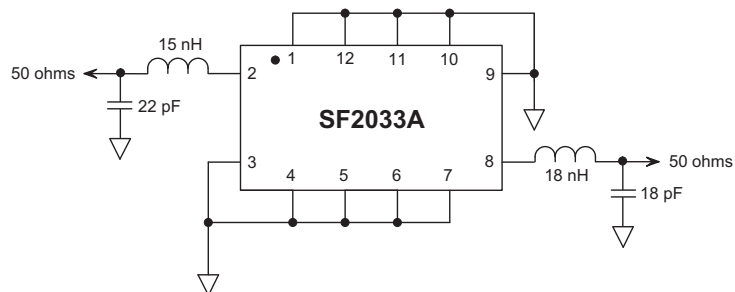

SM13365-12 Case

12-Terminal Ceramic Surface-Mount Case

13.3 x 6.5 mm Nominal Footprint

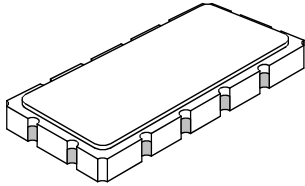

Case Dimensions						
Dimension	mm			Inches		
	Min	Nom	Max	Min	Nom	Max
A	13.08	13.31	13.60	0.515	0.524	0.535
B	6.27	6.50	6.80	0.247	0.256	0.268
C		1.91	2.00		0.075	0.079
D		1.50			0.059	
E		0.79			0.031	
H		1.0			0.039	
P		2.54			0.100	

Electrical Connections		
Connection		Terminals
Port 1	Input or Return	2
Port 2	Output or Return	8
	Ground	All others
Single-ended Operation		Return is ground

Materials	
Solder Pad Plating	0.3 to 1.0 μm Gold over 1.27 to 8.89 μm Nickel
Lid Plating	2.0 to 3.0 μm Nickel
Body	Al_2O_3 Ceramic
Pb Free	

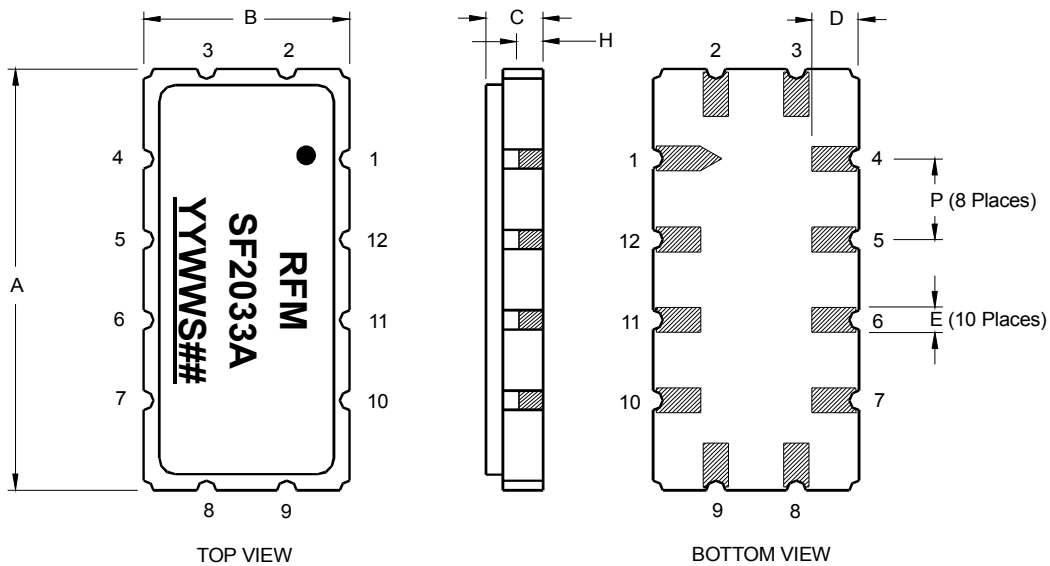

Reel Dimensions

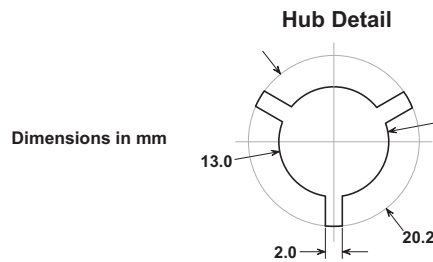
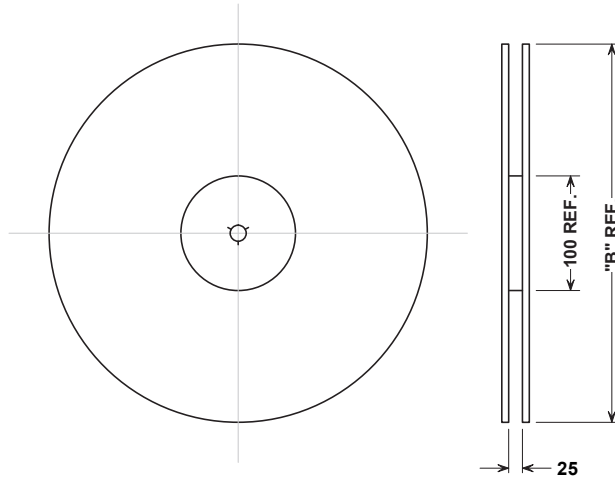

Tape Dimensions

