



# SP435W

## Dual OP AMP with Voltage Regulator

### DESCRIPTION

The SP435W is a monolithic IC specifically designed to control the output current and voltage levels of switch mode battery chargers and power supplies. The device contains two operational amplifiers and a precision shunt regulator. Op Amp 1 is designed for voltage control, whose non-inverting input internally connects to the output of the shunt regulator. Op Amp 2 is for current control with both inputs uncommitted. The IC offers the power converter designer a control solution that features increased precision with a corresponding reduction in system complexity and cost.

### APPLICATIONS

- Battery Power Equipment
- Linear Regulators
- Switch Power Supply
- Cellular Phone
- Digital Cameras
- Computer Disk Drivers
- Instrumentation

### FEATURES

- Input offset voltage: 0.5mV
- Supply current: 250 uA per Op Amp at 5.0V supply voltage
- Unity gain bandwidth: 1MHz
- Output voltage swing: 0 to (VCC- 1.5) V
- Power supply range: 3 to 18V
- Fixed output voltage reference: 2.5V
- Voltage tolerance: 1%
- Sink current capability from 0.2 to 80mA

### PIN CONFIGURATION ( SOP-8 )

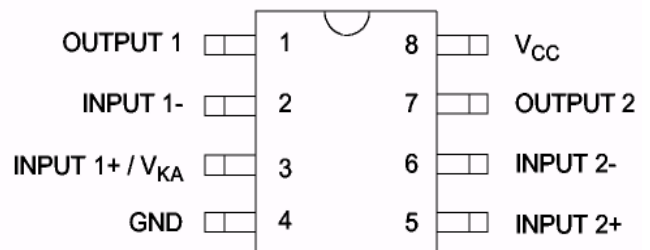

### PART MARKING

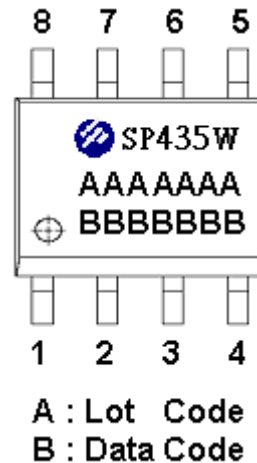



# SP435W Dual OP AMP with Voltage Regulator

## TYPICAL APPLICATION CIRCUIT

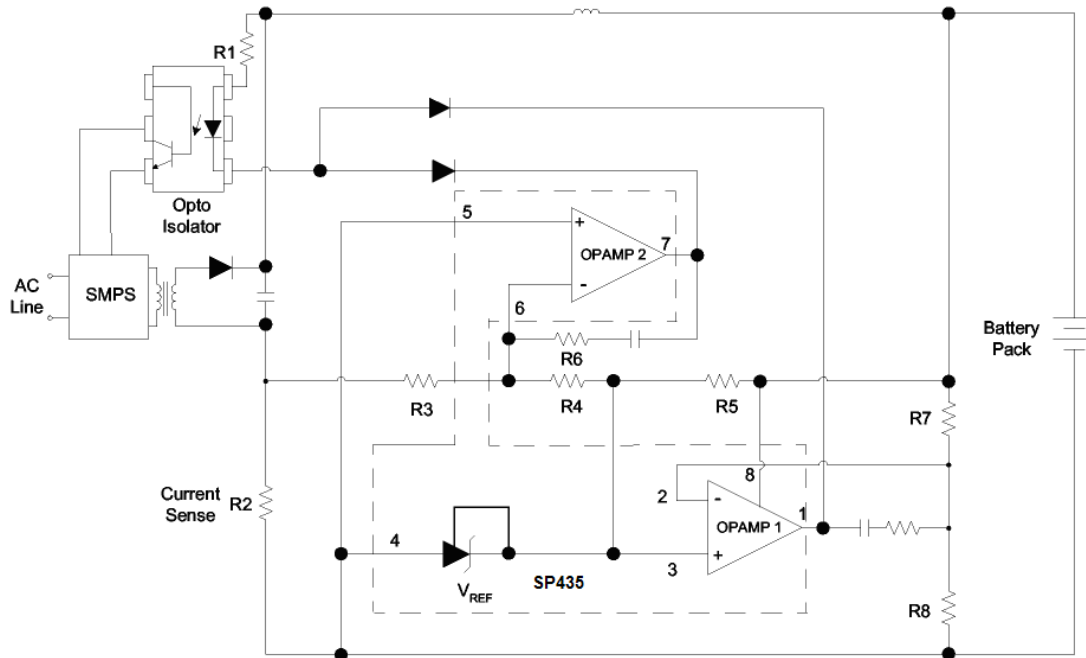

## PIN DESCRIPTION

Pin	Symbol	Description
1	Output 1	OP Amp Output 1
2	Input 1-	OP Amp Input 1 Voltage
3	Input 1+ V <sub>KA</sub>	Power Switching Output
4	GND	Ground
5	Input 2+	OP Amp Input 2 Voltage
6	Input 2-	OP Amp Input 2 Voltage
7	Output 2	OP Amp Output 2
8	V <sub>cc</sub>	Power Supply Voltage

## ORDERING INFORMATION

Part Number	Package	Part Marking
SP435WS8RGB	SOP-8	SP435W

※ SP435WS8RGB : 13" Tape Reel; Pb – Free, Halogen-Free



# SP435W

## Dual OP AMP with Voltage Regulator

### BLOCK DIAGRAM

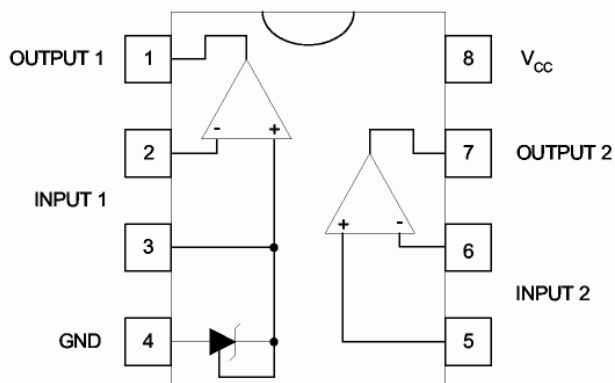

### ABSOLUTE MAXIMUM RATINGS (TA=25°C, unless otherwise specified.)

The following ratings designate persistent limits beyond which damage to the device may occur.

Symbol	Parameter	Value	Unit
V <sub>CC</sub>	DC Supply Voltage (V <sub>cc</sub> to Ground)	20	V
V <sub>IN</sub>	OP Amp 1 and 2 Input Voltage (Pin 2, 5, 6)	-0.3~V <sub>cc</sub> +0.3	V
V <sub>ID</sub>	OP Amp 2 Input Differential Voltage (Pin 5, 6)	20	V
I <sub>K</sub>	Voltage Reference Cathode Current (Pin 3)	100	mA
T <sub>STG</sub>	Storage Temperature Range	-65 to 150	°C
T <sub>LEAD</sub>	Lead Soldering Temperature for 5 sec.	260	°C
T <sub>ope</sub>	Operation Temperature Range	-40 ~ 85	°C
P <sub>D</sub>	Power Dissipation	500	mW



# SP435W

## Dual OP AMP with Voltage Regulator

### ELECTRICAL CHARACTERISTICS

(Unless otherwise stated, these specifications apply  $T_A=25^{\circ}\text{C}$ ;  $V_{CC}=+5\text{V}$ )

Symbol	Parameter	Conditions	Min.	Typ.	Max.	Unit
<b>SUPPLY</b>						
$V_{CC}$	Supply Voltage		3		18	V
$I_{CC}$	Supply Current, excluding Current in Voltage Reference	$V_{CC} = 5\text{V}$ , no load		0.45	0.6	mA
		$V_{CC} = 18\text{V}$ , no Load		0.6	0.8	
<b>VOLTAGE REFERENCE SECTION</b>						
$V_{REF}$	Reference Voltage	$I_{KA} = 10\text{ mA}$	2.475	2.5	2.525	V
$\Delta V_{REF}$	Reference Voltage Deviation over Temp Range	$I_{KA} = 10\text{ mA}$ , $T_A = -40\sim 85^{\circ}\text{C}$		5	24	mV
$I_{MIN}$	Minimum Cathode Current for Regulation	$V_{KA} = V_{REF}$		0.2	1.0	mA
$ Z_{KA} $	Dynamic Impedance	$V_{KA} = V_{REF}$ , $I_{KA} = 1\text{mA}\sim 80\text{mA}$ , $f < 1\text{KHz}$		0.3	0.5	$\Omega$
<b>OP AMP 1 SECTION (<math>V_{CC+} = 5\text{V}</math>, <math>V_O = 1.4\text{V}</math>)</b>						
$V_{IO}$	Input Offset Voltage	$T_A = 25^{\circ}\text{C}$		0.5	3.0	mV
		$T_A = -40^{\circ}\text{C}\sim 85^{\circ}\text{C}$			5.0	
$\alpha V_{IO}$	Input Offset Voltage Temperature Drift			7		$\mu\text{V}/^{\circ}\text{C}$
$I_{IB}$	Input Bias Current (Inverting Input Only)			20	150	nA
$A_{VD}$	Large Signal Voltage Gain	$V_{CC} = 15\text{V}$ , $R_L = 2\text{K}\Omega$ , $V_O = 1.4\sim 11.4\text{V}$	85	100		V/mV
$K_{SVR}$	Power Supply Rejection Ratio	$V_{CC+} = 5\sim 18\text{V}$	60	90		dB
$I_{O(SINK)}$	Output Sink Current	$V_{CC} = 15\text{V}$ , $V_{ID} = -1\text{V}$ , $V_O = 2\text{V}$	10	20		mA
$I_{O(SOURCE)}$	Output Source Current	$V_{CC} = 15\text{V}$ , $V_{ID} = 1\text{V}$ , $V_O = 2\text{V}$	20	40		mA
$V_{OH}$	Output Voltage Swing High	$V_{CC} = 18\text{V}$ , $V_{ID} = 1\text{V}$ , $R_L = 10\text{K}\Omega$	16	16.5		V
$V_{OL}$	Output Voltage Swing Low	$V_{CC} = 18\text{V}$ , $V_{ID} = -1\text{V}$ , $R_L = 10\text{K}\Omega$		17	100	mV
SR	Slew Rate	$V_{CC} = 18\text{V}$ , $R_L = 2\text{K}\Omega$ , $V_I = 0.5\sim 2\text{V}$ , $C_L = 100\text{ pF}$	0.2	0.5		$\text{V}/\mu\text{S}$
GBW	Gain Bandwidth Product	$V_{CC} = 18\text{V}$ , $R_L = 2\text{K}\Omega$ , $V_I = 10\text{mV}$ , $C_L = 100\text{ pF}$ , $f = 100\text{KHz}$	0.5	1		MHz



# SP435W

## Dual OP AMP with Voltage Regulator

Symbol	Parameter	Conditions	Min.	Typ.	Max.	Unit
<b>OP AMP 2 SECTION</b> ( $V_{CC+} = 5V$ , $V_O = 1.4V$ )						
$V_{IO}$	Input Offset Voltage	$T_A = 25^\circ C$		0.5	3.0	mV
		$T_A = -40^\circ C \sim 85^\circ C$			5.0	
$\alpha V_{IO}$	Input Offset Voltage Temperature Drift			7		$\mu V/^\circ C$
$I_{IO}$	Input Offset Current			2	30	nA
$I_{IB}$	Input Bias Current (Inverting Input Only)			20	150	nA
$V_{ICR}$	Input Common Mode Voltage Range	$V_{CC} = 18V$			$V_{CC} - 1.5$	V
CMRR	Common Mode Rejection Ratio	$T_A = 25^\circ C$ , $V_{CM} = 0 \sim 3.5V$	70	85		dB
$A_{VD}$	Large Signal Voltage Gain	$V_{CC} = 15V$ , $R_L = 2K\Omega$ , $V_O = 1.4 \sim 11.4V$	85	100		V/mV
$K_{SVR}$	Power Supply Rejection Ratio	$V_{CC+} = 5 \sim 18V$	60	90		dB
$I_{O(SINK)}$	Output Sink Current	$V_{CC} = 15V$ , $V_{ID} = -1V$ , $V_O = 2V$	10	20		mA
$I_{O(SOURCE)}$	Output Source Current	$V_{CC} = 15V$ , $V_{ID} = 1V$ , $V_O = 2V$	20	40		mA
$V_{OH}$	Output Voltage Swing High	$V_{CC} = 18V$ , $V_{ID} = 1V$ , $R_L = 10K\Omega$	16	16.5		V
$V_{OL}$	Output Voltage Swing Low	$V_{CC} = 18V$ , $V_{ID} = -1V$ , $R_L = 10K\Omega$		17	100	mV
SR	Slew Rate	$V_{CC} = 18V$ , $R_L = 2K\Omega$ , $V_I = 0.5 \sim 2V$ , $C_L = 100 pF$	0.2	0.5		$V/\mu S$
GBW	Gain Bandwidth Product	$V_{CC} = 18V$ , $R_L = 2K\Omega$ , $V_I = 10mV$ , $C_L = 100 pF$ , $f = 100KHz$	0.5	1		MHz



# SP435W Dual OP AMP with Voltage Regulator

## SOP- 8 PACKAGE OUTLINE

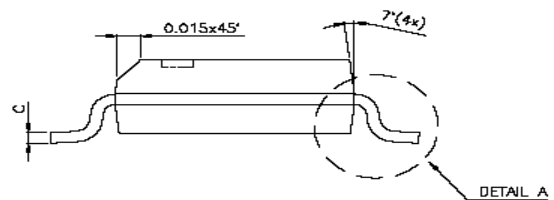
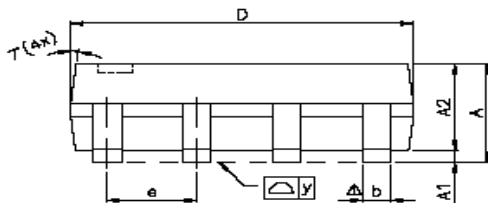
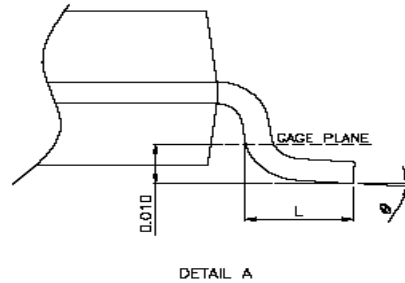
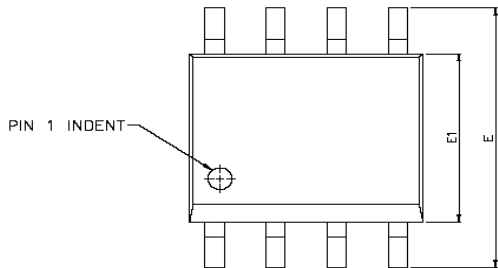

SYMBOLS	DIMENSIONS IN MILLIMETERS			DIMENSIONS IN INCHES		
	MIN	NOM	MAX	MIN	NOM	MAX
A	1.47	1.60	1.73	0.058	0.063	0.068
A1	0.10	—	0.25	0.004	—	0.010
A2	—	1.45	—	—	0.057	—
b	0.33	0.41	0.51	0.013	0.016	0.020
C	0.19	0.20	0.25	0.0075	0.008	0.0098
D	4.80	4.85	4.95	0.189	0.191	0.195
E	5.80	6.00	6.20	0.228	0.236	0.244
E1	3.80	3.90	4.00	0.150	0.154	0.157
e	—	1.27	—	—	0.050	—
L	0.38	0.71	1.27	0.015	0.028	0.050
$\Delta$ y	—	—	0.076	—	—	0.003
$\phi$	0°	—	8°	0°	—	8°



# SP435W

## Dual OP AMP with Voltage Regulator

---

Information provided is alleged to be exact and consistent. SYNC Power Corporation presumes no responsibility for the penalties of use of such information or for any violation of patents or other rights of third parties, which may result from its use. No license is granted by allegation or otherwise under any patent or patent rights of SYNC Power Corporation. Conditions mentioned in this publication are subject to change without notice. This publication surpasses and replaces all information previously supplied. SYNC Power Corporation products are not authorized for use as critical components in life support devices or systems without express written approval of SYNC Power Corporation.

©The SYNC Power logo is a registered trademark of SYNC Power Corporation  
©2011 SYNC Power Corporation – Printed in Taiwan – All Rights Reserved  
SYNC Power Corporation  
7F-2, No.3-1, Park Street  
NanKang District (NKSP), Taipei, Taiwan, 115, R.O.C  
Phone: 886-2-2655-8178  
Fax: 886-2-2655-8468  
<http://www.syncpower.com>