



STD35NF06

N-CHANNEL 60V - 0.018Ω - 35A DPAK

STripFET™II MOSFET

| TYPE | V _{DSS} | R _{DS(on)} | I _D |
|-----------|------------------|---------------------|----------------|
| STD35NF06 | 60 V | < 0.024 Ω | 35 A |

- TYPICAL R_{DS(on)} = 0.018 Ω
- EXTREMELY HIGH dv/dt CAPABILITY
- 100% AVALANCHE TESTED
- GATE CHARGE MINIMIZED

DESCRIPTION

This Power Mosfet is the latest development of ST-Microelectronics unique "Single Feature Size™" strip-based process. The resulting transistor shows extremely high packing density for low on-resistance, rugged avalanche characteristics and less critical alignment steps therefore a remarkable manufacturing reproducibility.

APPLICATIONS

- SOLENOID AND RELAY DRIVERS
- MOTOR CONTROL, AUDIO AMPLIFIERS
- DC-AC CONVERTERS
- AUTOMOTIVE ENVIRONMENT

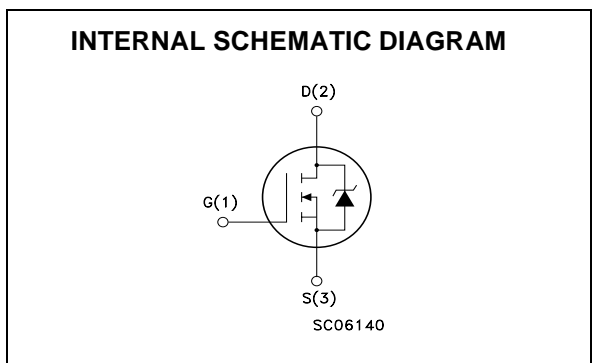
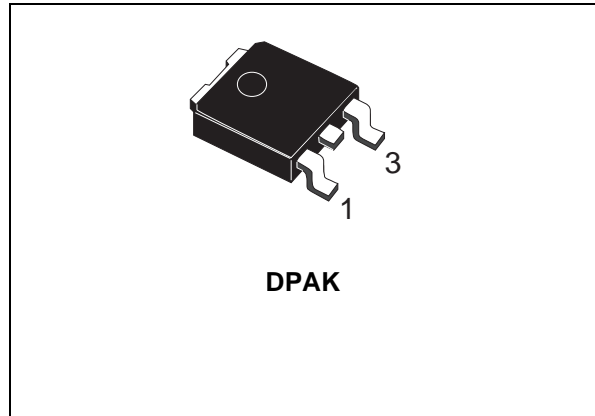

ABSOLUTE MAXIMUM RATINGS

| Symbol | Parameter | Value | Unit |
|---------------------|--|------------|------|
| V _{DS} | Drain-source Voltage (V _{GS} = 0) | 60 | V |
| V _{DGR} | Drain-gate Voltage (R _{GS} = 20 kΩ) | 60 | V |
| V _{GS} | Gate- source Voltage | ± 20 | V |
| I _D | Drain Current (continuous) at T _C = 25°C | 35 | A |
| I _D | Drain Current (continuous) at T _C = 100°C | 24.5 | A |
| I _{DM} (●) | Drain Current (pulsed) | 140 | A |
| P _{TOT} | Total Dissipation at T _C = 25°C | 55 | W |
| | Derating Factor | 0.37 | W/°C |
| dv/dt (1) | Peak Diode Recovery voltage slope | 5 | V/ns |
| T _{stg} | Storage Temperature | -55 to 175 | °C |
| T _j | Max. Operating Junction Temperature | | |

(*) Pulse width limited by safe operating area

(1) I_{SD} ≤ 35A, di/dt ≤ 100A/μs, V_{DD} ≤ V(BR)DSS, T_j ≤ T_{JMAX}.

STD35NF06

THERMAL DATA

| | | | |
|----------------|--|-----|------|
| Rthj-case | Thermal Resistance Junction-case Max | 2.7 | °C/W |
| Rthj-amb | Thermal Resistance Junction-ambient Max | 100 | °C/W |
| T _I | Maximum Lead Temperature For Soldering Purpose | 275 | °C |

AVALANCHE CHARACTERISTICS

| Symbol | Parameter | Max Value | Unit |
|-----------------|--|-----------|------|
| I _{AR} | Avalanche Current, Repetitive or Not-Repetitive (pulse width limited by T _j max) | 17.5 | A |
| E _{AS} | Single Pulse Avalanche Energy (starting T _j = 25 °C, I _D = I _{AR} , V _{DD} = 50 V) | 130 | mJ |

ELECTRICAL CHARACTERISTICS (TCASE = 25 °C UNLESS OTHERWISE SPECIFIED)

OFF

| Symbol | Parameter | Test Conditions | Min. | Typ. | Max. | Unit |
|----------------------|---|---|------|------|---------|----------|
| V _{(BR)DSS} | Drain-source Breakdown Voltage | I _D = 250 μA, V _{GS} = 0 | 60 | | | V |
| I _{DSS} | Zero Gate Voltage Drain Current (V _{GS} = 0) | V _{DS} = Max Rating V _{DS} = Max Rating, T _C = 125 °C | | | 1 10 | μA μA |
| I _{GSS} | Gate-body Leakage Current (V _{DS} = 0) | V _{GS} = ± 20V | | | ±100 | nA |

ON (1)

| Symbol | Parameter | Test Conditions | Min. | Typ. | Max. | Unit |
|---------------------|-----------------------------------|--|------|-------|-------|------|
| V _{GS(th)} | Gate Threshold Voltage | V _{DS} = V _{GS} , I _D = 250μA | 2 | 3 | 4 | V |
| R _{DS(on)} | Static Drain-source On Resistance | V _{GS} = 10V, I _D = 17.5 A | | 0.018 | 0.024 | Ω |

DYNAMIC

| Symbol | Parameter | Test Conditions | Min. | Typ. | Max. | Unit |
|---------------------|------------------------------|--|------|------|------|------|
| g _{fs} (1) | Forward Transconductance | V _{DS} > I _{D(on)} × R _{DS(on)max} , I _D = 17.5 A | | 13 | | S |
| C _{iss} | Input Capacitance | V _{DS} = 25V, f = 1 MHz, V _{GS} = 0 | | 1530 | | pF |
| C _{OSS} | Output Capacitance | | | 300 | | pF |
| C _{rss} | Reverse Transfer Capacitance | | | 105 | | pF |

ELECTRICAL CHARACTERISTICS (CONTINUED)

SWITCHING ON

| Symbol | Parameter | Test Conditions | Min. | Typ. | Max. | Unit |
|-------------|--------------------|--|------|------|------|------|
| $t_{d(on)}$ | Turn-on Delay Time | $V_{DD} = 30\text{ V}$, $I_D = 27.5\text{ A}$ $R_G = 4.7\Omega$, $V_{GS} = 10\text{ V}$ (see test circuit, Figure 3) | | 16 | | ns |
| t_r | Rise Time | | | 8 | | ns |
| Q_g | Total Gate Charge | $V_{DD} = 48\text{ V}$, $I_D = 55\text{ A}$, $V_{GS} = 10\text{ V}$ | | 44.5 | 60 | nC |
| Q_{gs} | Gate-Source Charge | | | 10.5 | | nC |
| Q_{gd} | Gate-Drain Charge | | | 17.5 | | nC |

SWITCHING OFF

| Symbol | Parameter | Test Conditions | Min. | Typ. | Max. | Unit |
|--------------|---------------------|--|------|------|------|------|
| $t_{d(off)}$ | Turn-off-Delay Time | $V_{DD} = 30\text{ V}$, $I_D = 27.5\text{ A}$, $R_G = 4.7\Omega$, $V_{GS} = 10\text{ V}$ (see test circuit, Figure 3) | | 36 | | ns |
| t_f | Fall Time | | | 15 | | ns |

SOURCE DRAIN DIODE

| Symbol | Parameter | Test Conditions | Min. | Typ. | Max. | Unit |
|--------------|-------------------------------|---|------|------|------|------|
| I_{SD} | Source-drain Current | | | | 35 | A |
| $I_{SDM(2)}$ | Source-drain Current (pulsed) | | | | 140 | A |
| $V_{SD(1)}$ | Forward On Voltage | $I_{SD} = 35\text{ A}$, $V_{GS} = 0$ | | | 1.5 | V |
| t_{rr} | Reverse Recovery Time | $I_{SD} = 35\text{ A}$, $di/dt = 100\text{ A}/\mu\text{s}$ $V_{DD} = 20\text{ V}$, $T_j = 150^\circ\text{C}$ (see test circuit, Figure 5) | | 75 | | ns |
| Q_{rr} | Reverse Recovery Charge | | | 170 | | nC |
| I_{RRM} | Reverse Recovery Current | | | 4.5 | | A |

Note: 1. Pulsed: Pulse duration = 300 μs , duty cycle 1.5 %.
2. Pulse width limited by safe operating area.

Safe Operating Area

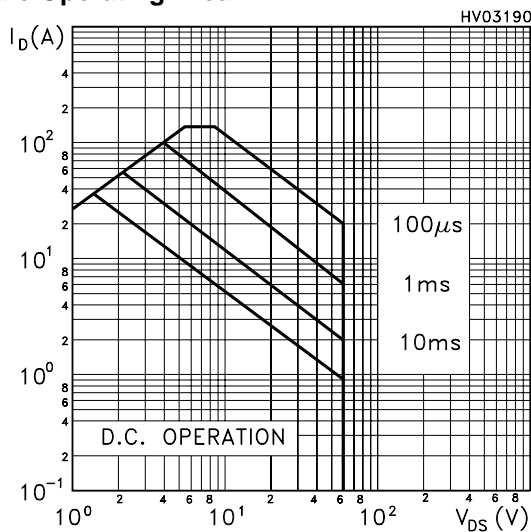

Thermal Impedance

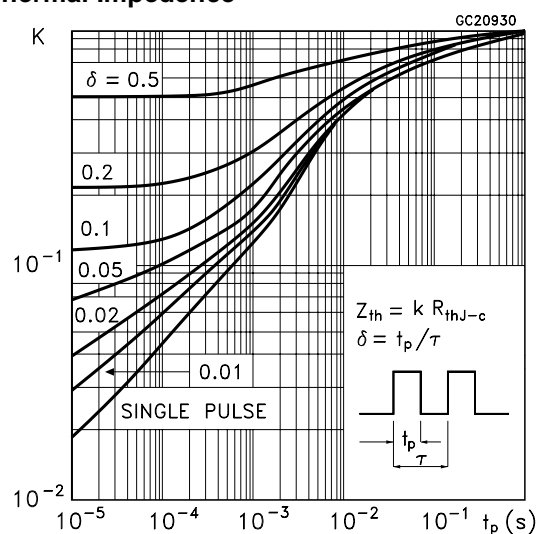

Output Characteristics

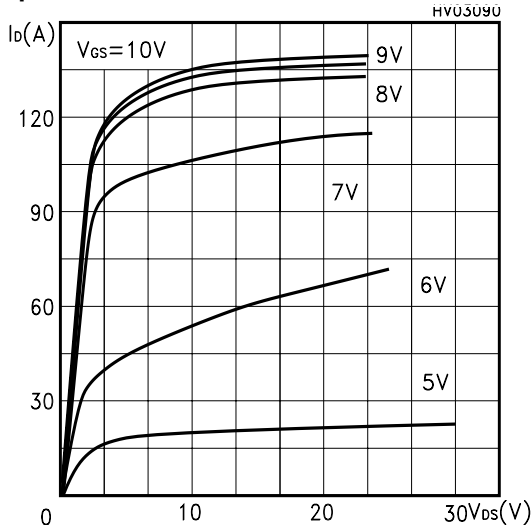

Transfer Characteristics

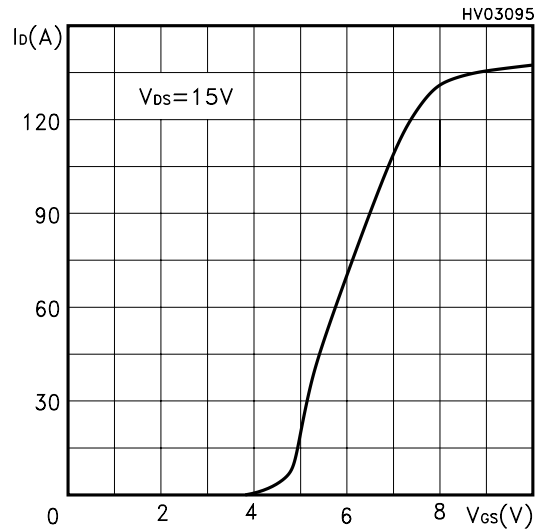

Transconductance

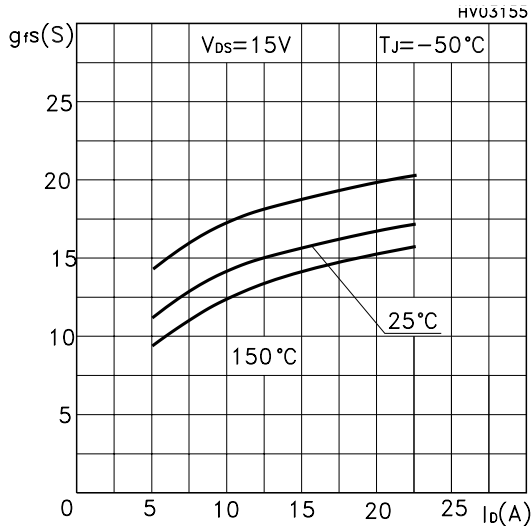

Static Drain-source On Resistance

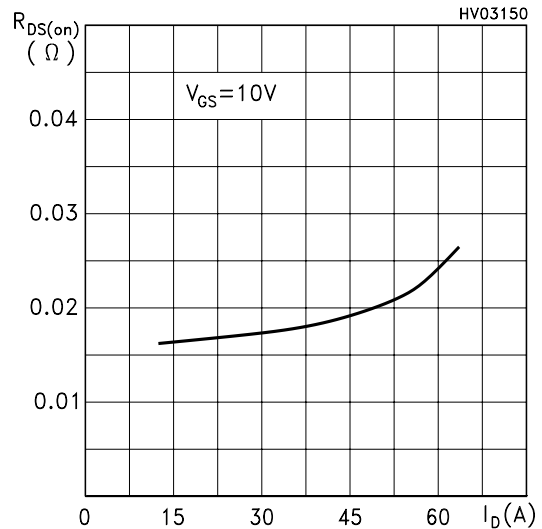

Gate Charge vs Gate-source Voltage

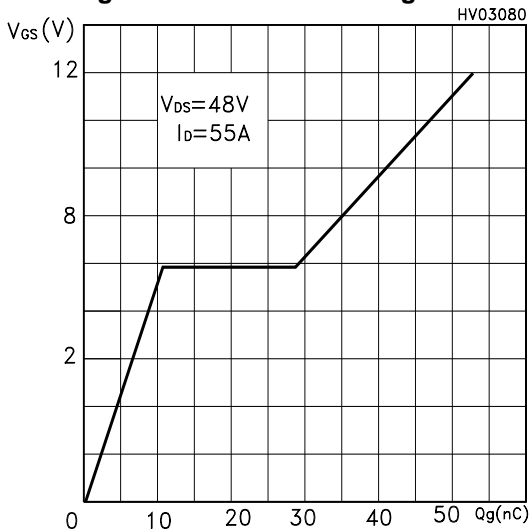

Capacitance Variations

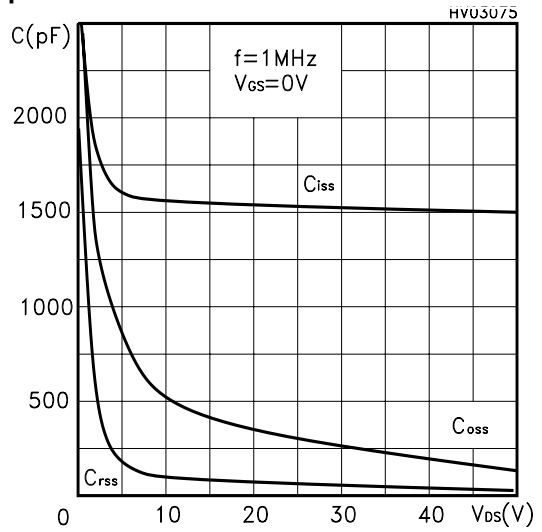

Normalized Gate Threshold Voltage vs Temp.

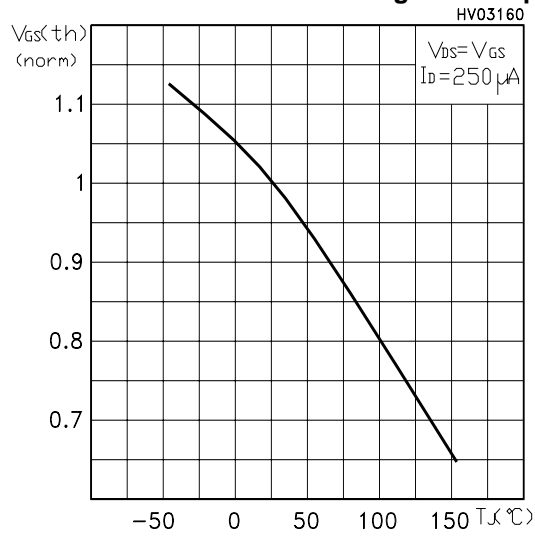

Normalized On Resistance vs Temperature

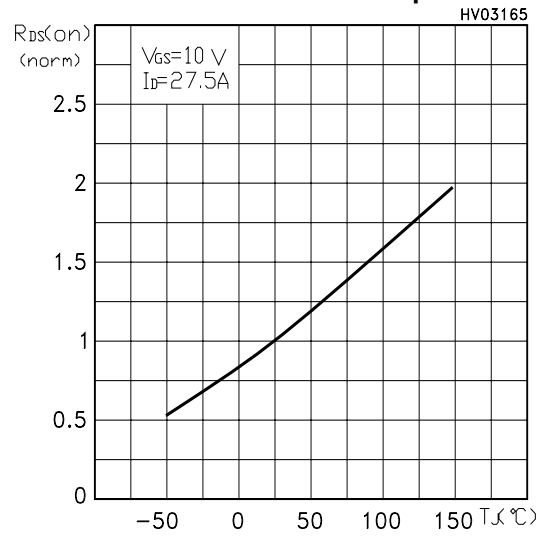

Source-drain Diode Forward Characteristics

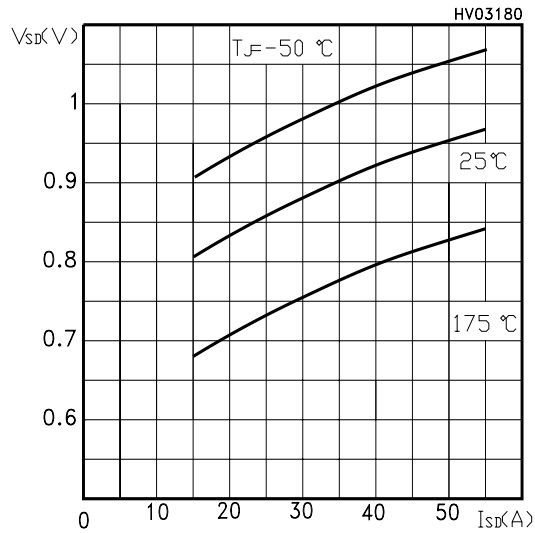

Fig. 1: Unclamped Inductive Load Test Circuit



Fig. 2: Unclamped Inductive Waveform



Fig. 3: Switching Times Test Circuit For Resistive Load



Fig. 4: Gate Charge test Circuit

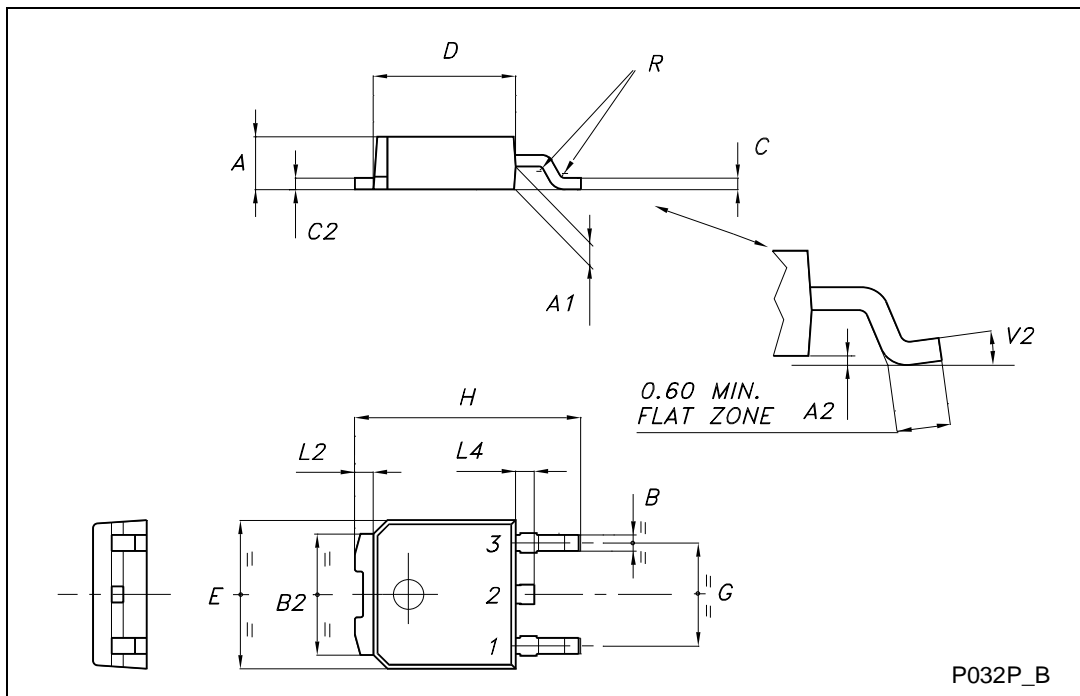

Fig. 5: Test Circuit For Inductive Load Switching And Diode Recovery Times



TO-252 (DPAK) MECHANICAL DATA

| DIM. | mm | | | inch | | |
|------|------|------|-------|-------|-------|-------|
| | MIN. | TYP. | MAX. | MIN. | TYP. | MAX. |
| A | 2.20 | | 2.40 | 0.087 | | 0.094 |
| A1 | 0.90 | | 1.10 | 0.035 | | 0.043 |
| A2 | 0.03 | | 0.23 | 0.001 | | 0.009 |
| B | 0.64 | | 0.90 | 0.025 | | 0.035 |
| B2 | 5.20 | | 5.40 | 0.204 | | 0.213 |
| C | 0.45 | | 0.60 | 0.018 | | 0.024 |
| C2 | 0.48 | | 0.60 | 0.019 | | 0.024 |
| D | 6.00 | | 6.20 | 0.236 | | 0.244 |
| E | 6.40 | | 6.60 | 0.252 | | 0.260 |
| G | 4.40 | | 4.60 | 0.173 | | 0.181 |
| H | 9.35 | | 10.10 | 0.368 | | 0.398 |
| L2 | | 0.8 | | | 0.031 | |
| L4 | 0.60 | | 1.00 | 0.024 | | 0.039 |
| V2 | 0° | | 8° | 0° | | 0° |



DPAK FOOTPRINT

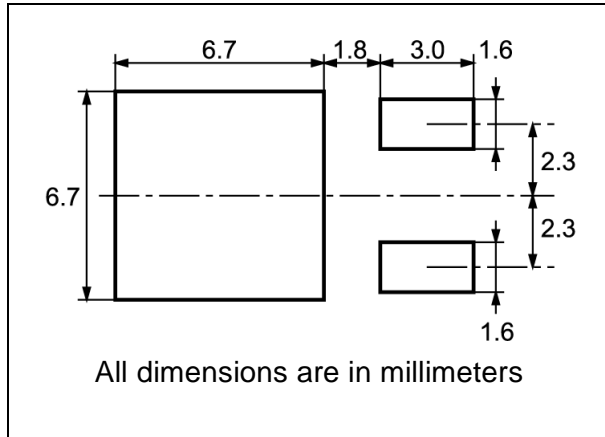

TUBE SHIPMENT (no suffix)*

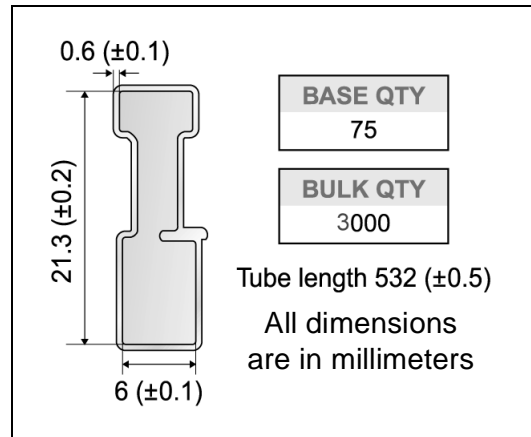

TAPE AND REEL SHIPMENT (suffix "T4")*

REEL MECHANICAL DATA

| DIM. | mm | | inch | |
|------|------|------|-------|--------|
| | MIN. | MAX. | MIN. | MAX. |
| A | | 330 | | 12.992 |
| B | 1.5 | | 0.059 | |
| C | 12.8 | 13.2 | 0.504 | 0.520 |
| D | 20.2 | | 0.795 | |
| G | 16.4 | 18.4 | 0.645 | 0.724 |
| N | 50 | | 1.968 | |
| T | | 22.4 | | 0.881 |

| BASE QTY | BULK QTY |
|----------|----------|
| 2500 | 2500 |

TAPE MECHANICAL DATA

| DIM. | mm | | inch | |
|------|------|------|-------|-------|
| | MIN. | MAX. | MIN. | MAX. |
| A0 | 6.8 | 7 | 0.267 | 0.275 |
| B0 | 10.4 | 10.6 | 0.409 | 0.417 |
| B1 | | 12.1 | | 0.476 |
| D | 1.5 | 1.6 | 0.059 | 0.063 |
| D1 | 1.5 | | 0.059 | |
| E | 1.65 | 1.85 | 0.065 | 0.073 |
| F | 7.4 | 7.6 | 0.291 | 0.299 |
| K0 | 2.55 | 2.75 | 0.100 | 0.108 |
| P0 | 3.9 | 4.1 | 0.153 | 0.161 |
| P1 | 7.9 | 8.1 | 0.311 | 0.319 |
| P2 | 1.9 | 2.1 | 0.075 | 0.082 |
| R | 40 | | 1.574 | |
| W | 15.7 | 16.3 | 0.618 | 0.641 |

* on sales type

Information furnished is believed to be accurate and reliable. However, STMicroelectronics assumes no responsibility for the consequences of use of such information nor for any infringement of patents or other rights of third parties which may result from its use. No license is granted by implication or otherwise under any patent or patent rights of STMicroelectronics. Specification mentioned in this publication are subject to change without notice. This publication supersedes and replaces all information previously supplied. STMicroelectronics products are not authorized for use as critical components in life support devices or systems without express written approval of STMicroelectronics.

The ST logo is a trademark of STMicroelectronics

© 2000 STMicroelectronics – Printed in Italy – All Rights Reserved

STMicroelectronics GROUP OF COMPANIES

Australia - Brazil - China - Finland - France - Germany - Hong Kong - India - Italy - Japan - Malaysia - Malta - Morocco -
Singapore - Spain - Sweden - Switzerland - United Kingdom - U.S.A.

<http://www.st.com>