



SEMIPACK® 1

Thyristor / Diode Modules

SKKH 72/18 E G6

Features

- Heat transfer through aluminium oxide ceramic isolated metal baseplate
- Hard soldered joints for high reliability
- UL recognized, file no. E63532

Typical Applications

- DC motor control (e. g. for machine tools)
- AC motor soft starters
- Temperature control (e. g. for ovens, chemical processes)
- Professional light dimming (studios, theaters)

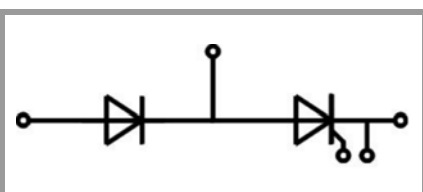

SKKH

Absolute Maximum Ratings				
Symbol	Conditions		Values	Unit
Chip				
$I_{T(AV)}$	sinus 180°	$T_c = 85\text{ °C}$	80	A
		$T_c = 100\text{ °C}$	60	A
I_{TSM}	10 ms	$T_j = 25\text{ °C}$	1600	A
		$T_j = 130\text{ °C}$	1450	A
i^2t	10 ms	$T_j = 25\text{ °C}$	12800	kA ² s
i^2t		$T_j = 130\text{ °C}$	10513	kA ² s
V_{RSM}			1900	V
V_{RRM}			1800	V
V_{DRM}			1800	V
$(di/dt)_{cr}$	$T_j = 130\text{ °C}$		140	A/μs
$(dv/dt)_{cr}$	$T_j = 130\text{ °C}$		1000	V/μs
T_j			-40 ... 130	°C
Module				
T_{stg}			-40 ... 125	°C
V_{isol}	a.c.; 50 Hz; r.m.s.	1 min	3000	V
		1 s	3600	V

Characteristics						
Symbol	Conditions		min.	typ.	max.	Unit
Chip						
V_T	$T_j = 25\text{ °C}, I_T = 300\text{ A}$			1.75	1.9	V
$V_{T(TO)}$	$T_j = 130\text{ °C}$			0.9	1	V
r_T	$T_j = 130\text{ °C}$			4.00	4.50	mΩ
$I_{DD}; I_{RD}$	$T_j = 130\text{ °C}, V_{DD} = V_{DRM}; V_{RD} = V_{RRM}$				20	mA
t_{gd}	$T_j = 25\text{ °C}, I_G = 1\text{ A}, di_G/dt = 1\text{ A/μs}$			1		μs
t_{gr}	$V_D = 0.67 * V_{DRM}$			2		μs
t_q	$T_j = 130\text{ °C}$			200		μs
I_H	$T_j = 25\text{ °C}$			150	250	mA
I_L	$T_j = 25\text{ °C}, R_G = 33\text{ Ω}$			300	600	mA
V_{GT}	$T_j = 25\text{ °C}, \text{d.c.}$		2.5			V
I_{GT}	$T_j = 25\text{ °C}, \text{d.c.}$		100			mA
V_{GD}	$T_j = 130\text{ °C}, \text{d.c.}$				0.25	V
I_{GD}	$T_j = 130\text{ °C}, \text{d.c.}$				4	mA
$R_{th(j-c)}$	cont.	per chip			0.280	K/W
		per module			0.140	K/W
$R_{th(j-c)}$	sin. 180°	per chip			0.300	K/W
		per module			0.150	K/W
$R_{th(j-c)}$	rec. 120°	per chip			0.320	K/W
		per module			0.160	K/W
Module						
$R_{th(c-s)}$	chip			0.22		K/W
	module			0.11		K/W
M_s	to heatsink M5		4.25		5.75	Nm
M_t	to terminals M5		2.55		3.45	Nm
a					5 * 9,81	m/s ²
w				75		g

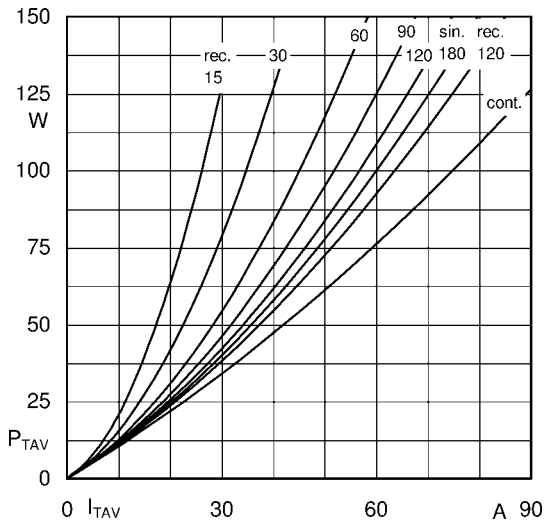

Fig. 1L: Max. power dissipation per chip vs. on-state current

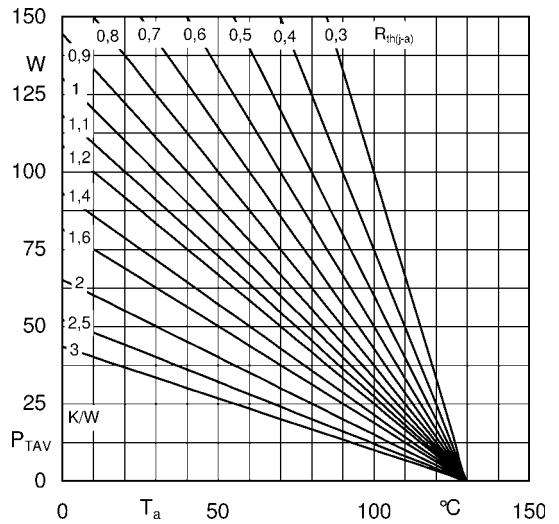

Fig. 1R: Max. power dissipation per chip vs. ambient temperature

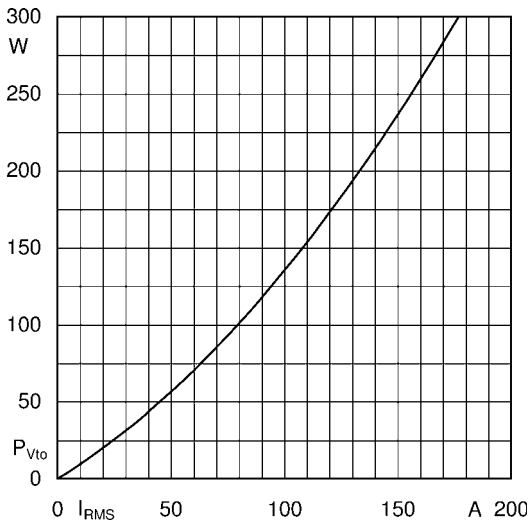

Fig. 2L: Max. power dissipation of one module vs. rms current

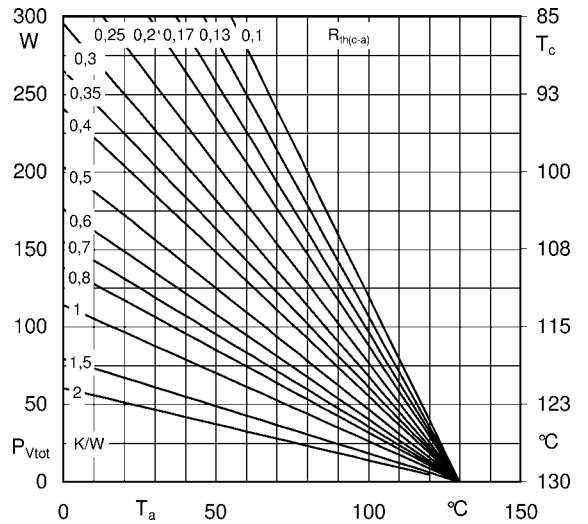

Fig. 2R: Max. power dissipation of one module vs. case temperature

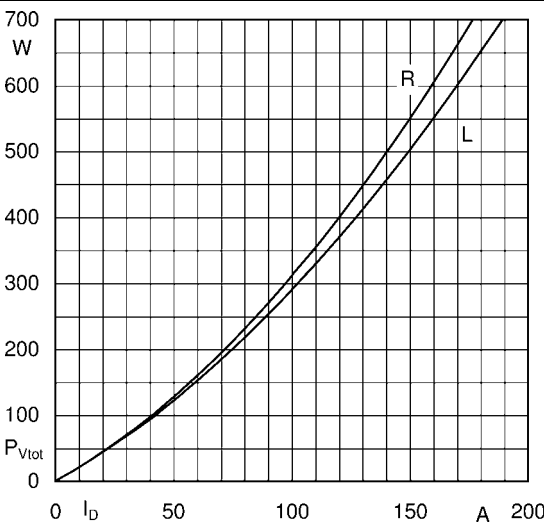

Fig. 3L: Max. power dissipation of two modules vs. direct current

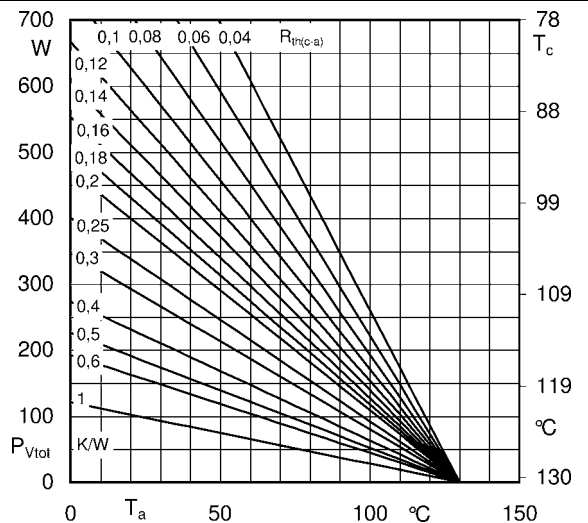

Fig. 3R: Max. power dissipation of two modules vs. case temperature

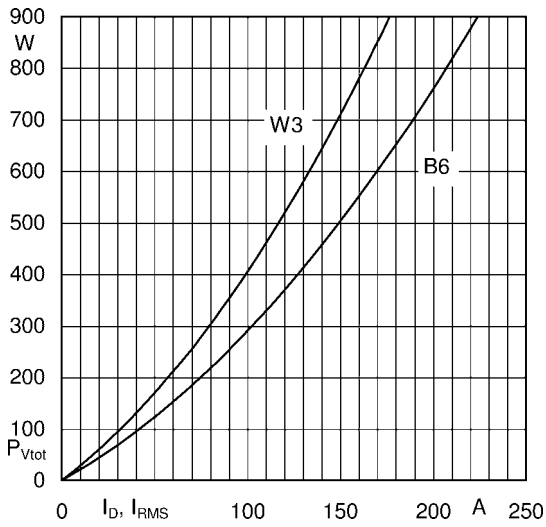

Fig. 4L: Max. power dissipation of three modules vs. direct current

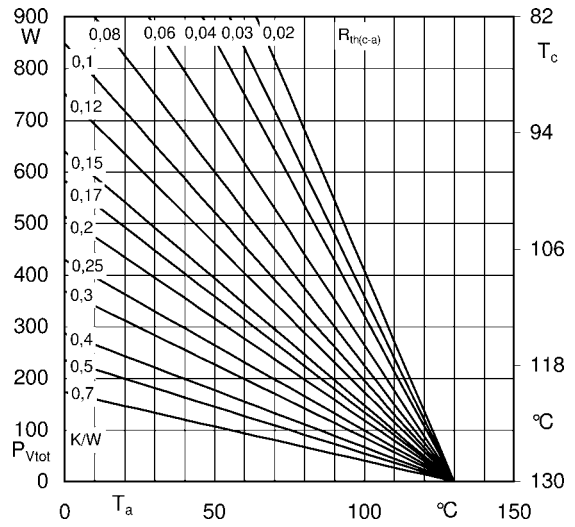

Fig. 4R: Max. power dissipation of three modules vs. case temperature

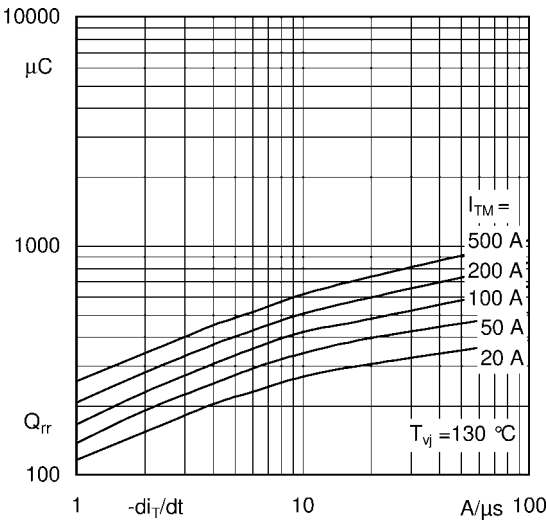

Fig. 5: Recovered charge vs. current decrease

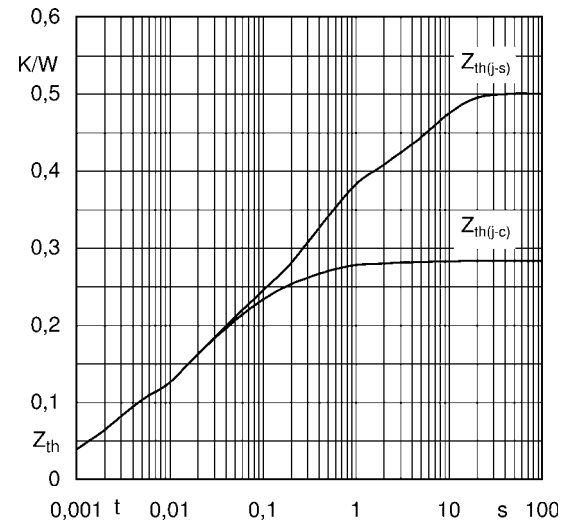

Fig. 6: Transient thermal impedance vs. time

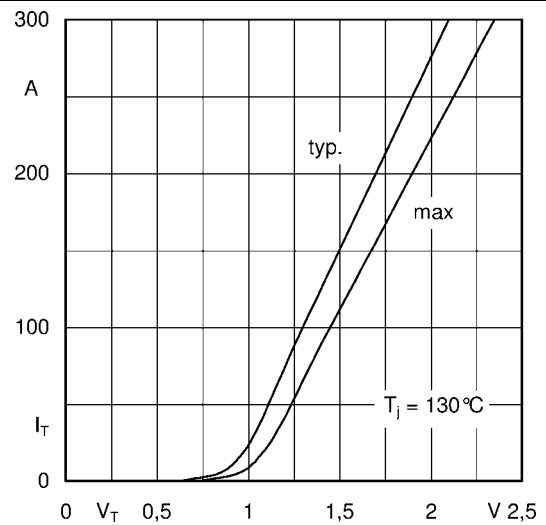

Fig. 7: On-state characteristics

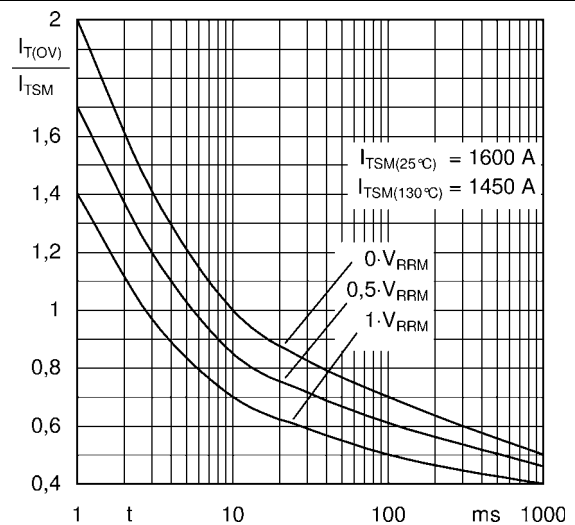

Fig. 8: Surge overload current vs. time

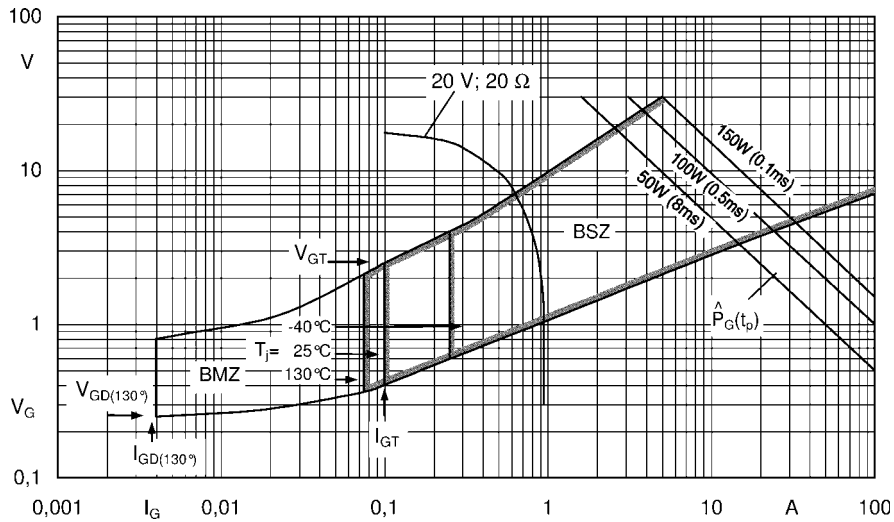
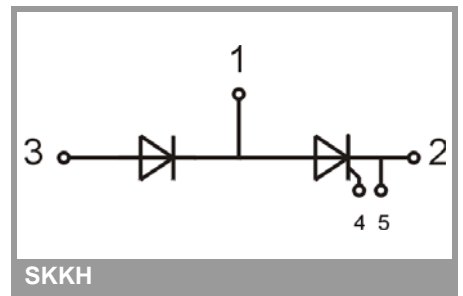
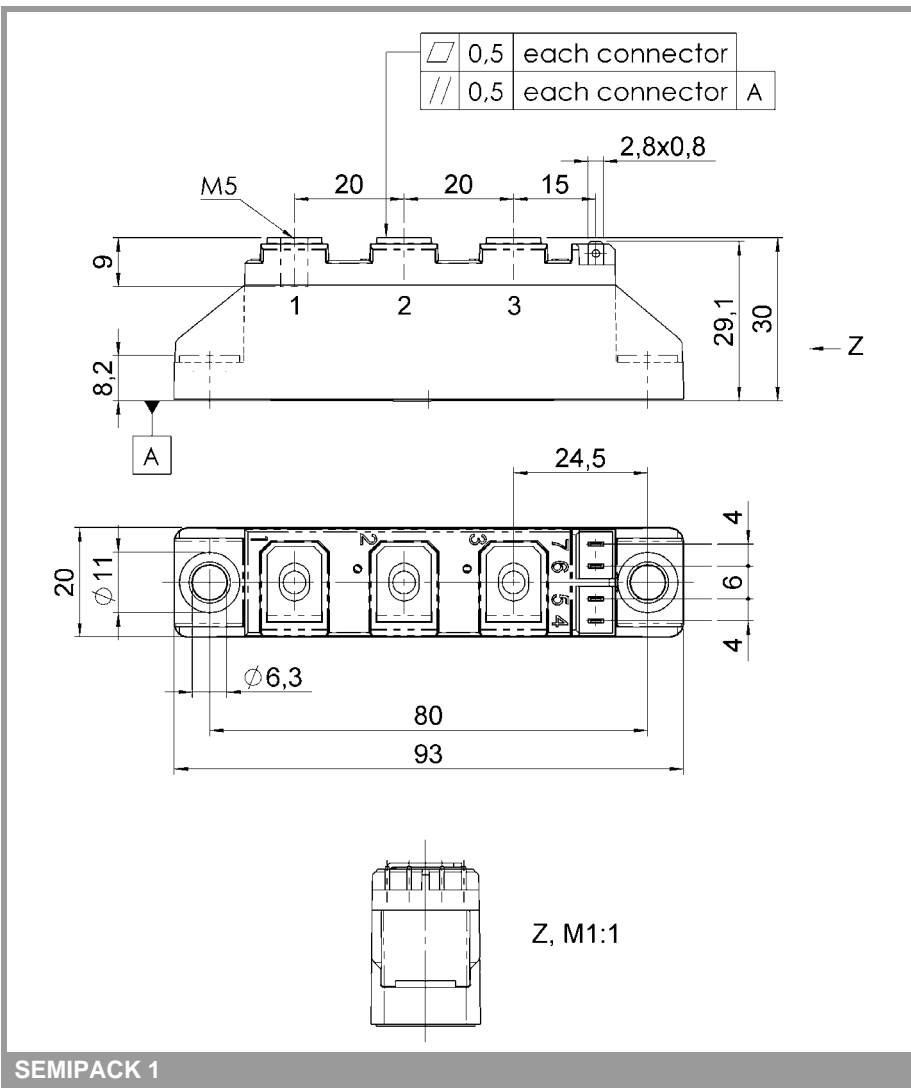

Fig. 9: Gate trigger characteristics



SKKH

SEMPACK 1

This technical information specifies semiconductor devices but promises no characteristics. No warranty or guarantee expressed or implied is made regarding delivery, performance or suitability.