

# Transformer

Model:TMS91365CT

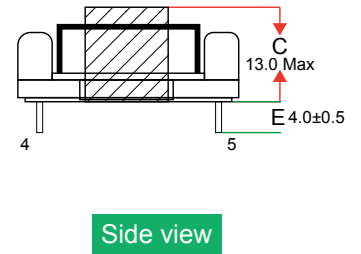
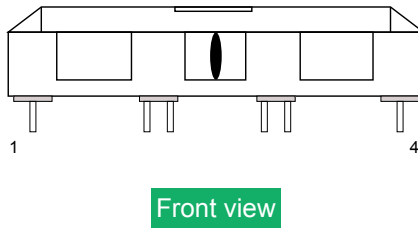
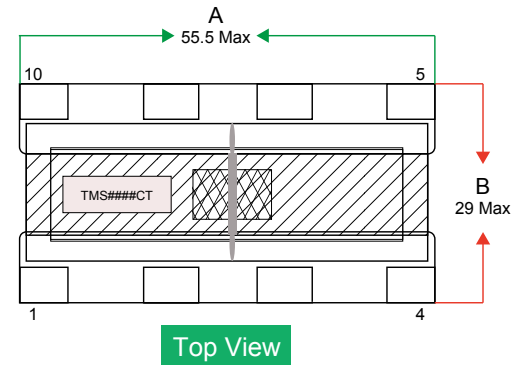
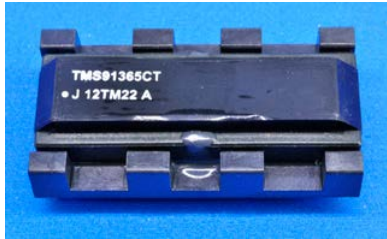

## Test data—inspection report

TEST ITEM	L(1-2)	L(4-3)	L(6,7-8,9)	LK(1-2)	LK(4-3)
UNIT	H	H	uH	mH	mH
TEST CONDITOOON	1KHZ, 1V	1KHZ, 1V	1KHZ, 1V short 6,7-8,9	Short 6,7-8,9 50KHZ, 1V	Short 6,7-8,9 50KHZ, 1V
SPEC	2.3MIN	2.3MIN	277.0MIN	430±10%	430±10%
1	3.84	3.87	451	430	430
2	4.42	4.45	525	435	429
3	4.30	4.26	509	434	426
4	4.39	4.39	518	431	430
5	4.27	4.27	509	433	420
6	4.37	4.39	516	430	431
7	4.66	4.68	562	433	431
8	4.17	4.18	492	425	431
9	4.60	4.62	548	435	434
10	4.00	4.00	475	441	434
11	4.18	4.17	493	426	430
12	4.75	4.74	568	424	432

TEST ITEM	DCR(1-2)	DCR(4-3)	DCR(6,7-8,9)	DIMENSION A	DIMENSION B	DIMENSION C	DIMENSION D	DIMENSION E
UNIT	$\Omega$	$\Omega$	m $\Omega$	mm	mm	mm	mm	mm
TEST CONDITOOON	/	/	Short 6,7,8,9	/	/	/	/	/
SPEC	900-1100	900-1100	130MAX	55.5MAX	29.5MAX	14.0MAX	23.3 $\pm$ 0.5	4.0 $\pm$ 0.5
1	943	949	89.8	54.02	28.79	12.63	23.15	4.00
2	941	944	90.6	54.46	28.81	12.59	23.23	4.03
3	951	950	89.2	54.10	28.77	12.67	23.17	4.01
4	969	984	89.5	54.10	28.65	12.82	23.21	4.10
5	968	955	89.6	54.01	28.72	12.81	23.13	4.04
6	935	934	88.6	54.45	28.70	12.66	23.15	4.04
7	962	951	88.8	54.02	28.86	12.71	23.14	4.08
8	982	968	89.1	54.34	28.74	12.52	23.27	4.05
9	964	969	90.0	54.07	28.78	12.66	23.23	4.00
10	952	960	88.4	54.44	28.74	12.86	23.31	4.03
11	975	967	88.9	54.17	28.83	12.55	23.22	4.01
12	958	952	88.8	54.38	28.79	12.66	23.23	4.02

INSPECTION ITEM		AOL	RESULT	<b>USION</b>  ACCEPTED REJECTED  WE CERTEIFY THAT ALL PRODUCTS HAD PASSED HI-POT TEST.
1	IR	Maj	/	
2	ELEC.CHARATERISTICS	Maj	OK	
3	MECHANICAL DIMENSION	Maj	OK	
4	APPEARANCE	Min	OK	
5	MARKING TMS91365CT . J 12TM22A	Maj	OK	
6	TERMINAL PULL TEST	Min	/	
7	OPERATING TORQUE	Maj	/	
8	SOLDERABILITY	Maj	/	
9	PACKING	Maj	OK	
10	HI-POT: P-S 2.0KVac 3mA 2Sec	Cri	OK	
	P-C 2.0KVac 3mA 2Sec	Cri	OK	
	S-C 3.5KVac 3mA 2Sec	Cri	OK	
Checked By		Prepared By		TEST CONDITION TEMPERATURE 25°C      HUMIDITY: 72%RH

# Transformer

Model:TMS91429CT

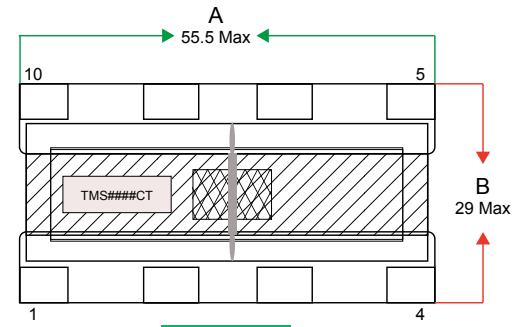

Top View

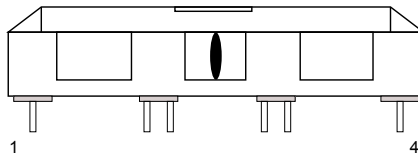

Front view

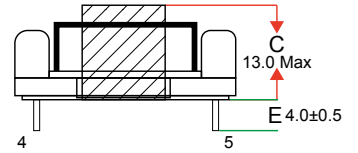

Side view

## Test data—inspection report

TEST ITEM	L(1-2)	L(4-3)	L(6,7-8,9)	LK(1-2)	LK(4-3)
UNIT	H	H	uH	mH	mH
TEST CONDITOOON	1KHZ, 1V	1KHZ, 1V	1KHZ, 1V	10KHZ, 1V Shortpin 6,7-8,9	10KHZ, 1V Shortpin 6,7-8,9
SPEC	1.52MIN	1.52MIN	45.0MIN	280±10%	280±10%
1	2.83	2.83	90.70	287	283
2	3.10	3.10	100.20	284	290
3	2.88	2.87	92.40	287	285
4	2.32	2.33	72.90	284	282
5	2.65	2.66	84.60	282	282
6	2.90	2.90	93.90	287	291
7	2.90	2.91	93.90	286	287
8	3.30	3.30	107.60	287	285
9	3.06	3.06	100.20	284	284
10	3.00	3.00	97.20	284	291
11	2.73	2.73	87.80	283	286
12	2.86	2.88	93.30	282	287

TEST ITEM	L(1-2)	DCR(4-3)	DCR(6,7-8,9)	DIMENSION A	DIMENSION B	DIMENSION C	DIMENSION D	DIMENSION E
UNIT	KΩ	KΩ	mΩ	mm	mm	mm	mm	mm
TEST CONDITOOON	/	/	/	/	/	/	/	/
SPEC	1.15~1.4	1.15~1.4	30MAX	55.5MAX	29.5MAX	14.0MAX	23.3±0.5	4.0±0.5
1	1.24	1.24	17.30	54.44	28.78	12.77	23.31	4.16
2	1.24	1.25	17.50	54.46	28.76	12.86	23.35	4.04
3	1.25	1.25	19.20	54.38	28.80	12.76	23.28	4.14
4	1.23	1.23	17.90	54.55	28.78	12.81	23.30	3.97
5	1.24	1.24	17.70	54.49	28.86	12.78	23.28	4.16
6	1.23	1.22	17.60	54.34	28.81	12.73	23.27	3.95
7	1.24	1.24	18.60	54.47	28.77	12.89	23.42	4.18
8	1.25	1.25	18.80	54.41	28.72	12.86	23.31	4.16
9	1.25	1.25	17.80	54.42	28.84	12.83	23.34	4.15
10	1.19	1.19	16.90	54.43	28.72	12.78	23.22	4.02
11	1.21	1.21	17.80	54.38	28.74	12.86	23.35	4.03
12	1.24	1.24	17.70	54.42	28.80	12.84	23.37	4.15

INSPECTION ITEM		AOL	RESULT	USION  ACCEPTED REJECTED  WE CERTEIFY THAT ALL PRODUCTS HAD PASSED HI-POT TEST.
1	IR	Maj	/	
2	ELEC.CHARATERISTICS	Maj	OK	
3	MECHANICAL DIMENSION	Maj	OK	
4	APPEARANCE	Min	OK	
5	MARKING TMS91429CT . M 12TM22 A	Maj	OK	
6	TERMINAL PULL TEST	Min	/	
7	OPERATING TORQUE	Maj	/	
8	SOLDERABILITY	Maj	/	
9	PACKING	Maj	OK	
10	HI-POT: P-S 2.0KVac 3mA 2Sec	Cri	OK	
	P-C 2.0KVac 3mA 2Sec	Cri	OK	
	S-C 3.5KVac 3mA 2Sec	Cri	OK	
Checked By		Prepared By		TEST CONDITION TEMPERATURE 25°C HUMIDITY: 72%RH

# Transformer

Model:TMS91573CT

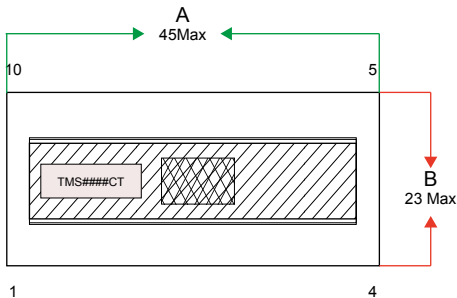

Top View

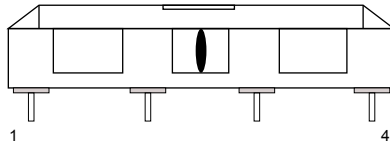

Front view

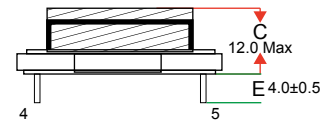

Side view

## Test data—inspection report

TEST ITEM	L(2-7)	L(3-6)	L(1-8)	L(4-5)	LK(1-8)	LK(4-5)
UNIT	uH	uH	H	H	mH	mH
TEST CONDITOOON	1KHZ, 1V	1KHZ, 1V	1KHZ, 1V	1KHZ, 1V	50KHZ, 1V Short pri	50KHZ, 1V Short pri
SPEC	82.0MIN	82.0MIN	2.7MIN	2.7MIN	260±10%	260±10%
1	123.0	123.0	3.97	3.98	255	256
2	130.0	130.0	4.17	4.17	253	252
3	123.0	124.0	3.98	3.98	249	246
4	132.0	132.0	4.26	4.25	257	251
5	117.0	117.0	3.78	3.78	250	250
6	130.0	130.0	4.19	4.19	257	256
7	124.0	124.0	3.98	3.98	253	250
8	126.0	126.0	4.08	4.07	257	251
9	119.0	119.0	3.82	3.83	252	249
10	127.0	128.0	4.10	4.11	255	256
11	133.0	133.0	4.25	4.25	249	246
12	135.0	135.0	4.33	4.32	253	250

TEST ITEM	DCR(1-8)	DCR(4-5)	DCR(2-7)	DCR(3-6)	IR(P-S)	IR(P-C)	IR(C-S)
UNIT	Ω	Ω	MΩ	MΩ	MΩ	MΩ	MΩ
TEST	/	/	/	/	500VDC	500VDC	500VDC
CONDITOOON							
SPEC	550~665	550~665	35.6 MAX	35.6 MAX	100MIN	100MIN	100MIN
1	588	591	30.50	31.30	OK	OK	OK
2	609	608	31.10	31.00	OK	OK	OK
3	610	605	30.50	31.20	OK	OK	OK
4	593	590	30.80	31.60	OK	OK	OK
5	592	599	31.20	31.30	OK	OK	OK
6	582	584	32.30	31.10	OK	OK	OK
7	597	596	30.60	30.70	OK	OK	OK
8	586	584	30.90	30.30	OK	OK	OK
9	603	601	31.60	31.30	OK	OK	OK
10	589	589	30.50	29.80	OK	OK	OK
11	591	590	30.20	30.70	OK	OK	OK
12	591	588	30.10	30.20	OK	OK	OK

INSPECTION ITEM		AOL	RESULT	USION  ACCEPTED REJECTED  WE CERTEIFY THAT ALL PRODUCTS HAD PASSED HI-POT TEST.
1	IR	Maj	OK	
2	ELEC.CHARATERISTICS	Maj	OK	
3	MECHANICAL DIMENSION	Maj	OK	
4	APPEARANCE	Min	OK	
5	MARKING TMS91573CT . 12TM22A	Maj	OK	
6	TERMINAL PULL TEST	Min	/	
7	OPERATING TORQUE	Maj	/	
8	SOLDERABILITY	Maj	/	
9	PACKING	Maj	OK	
10	HI-POT: P-S 1.5KVac 60HZ 5mA 2S	Cri	OK	
	P-C 1.5KVac 60HZ 5mA 2S	Cri	OK	
	S-C 2.4KVac 60HZ 5mA2S	Cri	OK	
Checked By		Prepared By		TEST CONDITION TEMPERATURE 25°C HUMIDITY: 70%RH

# Transformer

Model:TMS91904CT

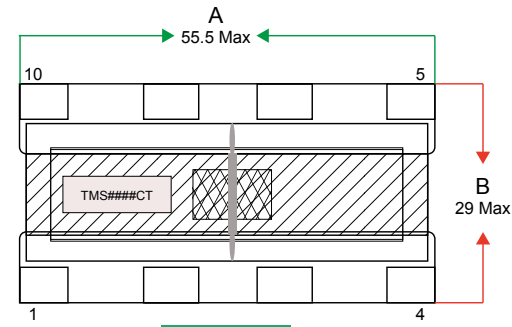
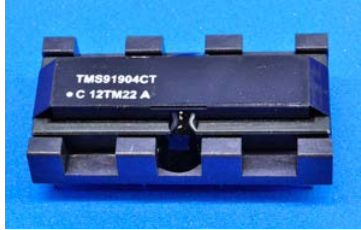

Top View

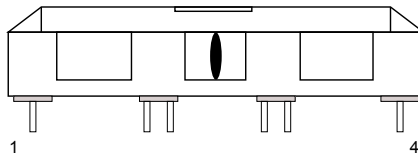

Front view

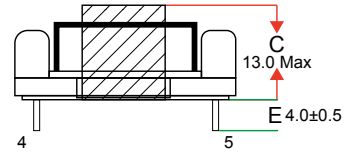

Side view

## Test data—inspection report

TEST ITEM	L(1-2)	L(4-3)	L(6,7-8,9)	LK <sub>1</sub> (1-2)	LK <sub>2</sub> (4-3)
UNIT	H	H	uH	mH	mH
TEST CONDITOOON	1KHZ, 1V	1KHZ, 1V	1KHZ, 1V	Short 6,7-8,9 10KHZ, 1V	Short 6,7-8,9 10KHZ, 1V
SPEC	1.4MIN	1.4MIN	45.0MIN	300±10%	300±10%
1	3.07	3.04	101.5	297	299
2	2.96	2.96	100.2	291	292
3	3.23	3.23	109.0	297	301
4	3.45	3.45	117.0	295	298
5	3.60	3.60	122.5	302	299
6	2.89	2.90	96.5	296	290
7	3.49	3.48	118.2	298	297
8	2.80	2.82	95.7	298	302
9	2.63	2.63	88.1	296	293
10	3.10	3.11	104.5	302	299
11	3.19	3.19	109.4	295	299
12	2.93	2.93	99.0	300	302

TEST ITEM	DCR(1-2)	DCR(4-3)	DCR(6,7-8,9)	DIMENSION A	DIMENSION B	DIMENSION C	DIMENSION D	DIMENSION E
UNIT	Ω	Ω	mΩ	mm	mm	mm	mm	mm
TEST CONDITOOON	/	/		/	/	/	/	/
SPEC	900~1090	900~1090	30MAX	55.5MAX	29.5MAX	14.0MAX	23.3±0.5	4.0±0.5
1	975	975	18.90	54.38	28.86	12.64	23.39	3.95
2	982	982	17.20	54.46	28.89	12.71	23.42	4.00
3	976	979	18.60	54.48	28.85	12.81	23.31	3.96
4	969	971	20.40	54.44	28.83	12.65	23.43	4.00
5	978	981	20.30	54.24	28.71	12.51	23.30	4.00
6	978	980	18.30	54.21	28.64	12.62	23.30	4.03
7	974	977	20.60	54.11	28.68	12.63	23.45	4.04
8	990	992	18.30	54.12	28.69	12.55	23.40	4.00
9	953	956	21.30	54.18	28.76	12.67	23.25	4.05
10	976	979	18.80	54.23	28.68	12.68	23.38	4.05
11	975	976	20.60	54.18	28.71	12.57	23.30	4.05
12	978	981	20.80	54.44	28.81	12.73	23.37	3.98

INSPECTION ITEM		AOL	RESULT	USION
1	IR	Maj	OK	
2	ELEC.CHARATERISTICS	Maj	OK	
3	MECHANICAL DIMENSION	Maj	OK	
4	APPEARANCE	Min	OK	
5	MARKING TMS91904CT . C 12TM22 A	Maj	OK	
6	TERMINAL PULL TEST	Min	/	
7	OPERATING TORQUE	Maj	/	
8	SOLDERABILITY	Maj	/	
9	PACKING	Maj	OK	
10	HI-POT: P-S 2.0KVac 3mA 2S P-C 2.0KVac 3mA2S S-C 3.5KVac 3mA 2S	Cri Cri Cri	OK OK OK	
Checked By		Prepared By		TEST CONDITION TEMPERATURE 25°C HUMIDITY: 86%RH



# Transformer

Model:TMS92515CT

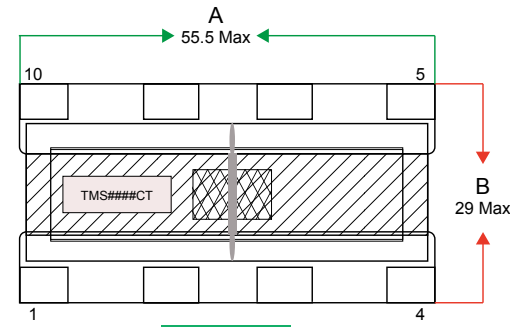
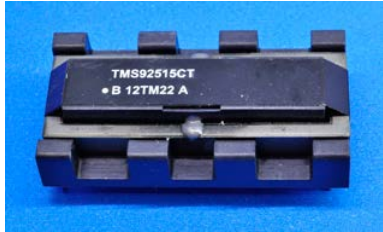

Top View

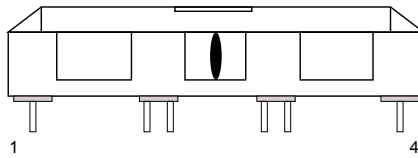

Front view

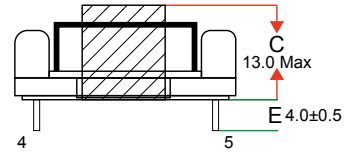

Side view

## Test data—inspection report

TEST ITEM	L(1-2)	L(4-3)	L(6,7-8,9)	LK(1-2)	LK(4-3)	DCR(1-2)	DCR(4-3)	DCR(6,7-8,9)
UNIT	H	H	uH	mH	mH	KΩ	KΩ	mΩ
TEST CONDITioon	1KHZ, 1.0V	1KHZ, 1V	1KHZ, 1V	Short pri 6,7-8,9 10KHZ, 1V	Short pri 6,7-8,9 10KHZ, 1V	/	/	/
SPEC	1.8MIN	1.8MIN	59.0MIN	325.0±10%	325.0±10%	1.05~1.22	1.05~1.22	35.0MAX
1	3.05	3.03	97.30	325.0	333.0	1.13	1.13	19.90
2	3.22	3.22	103.00	318.0	321.0	1.12	1.11	20.10
3	2.99	3.00	94.80	317.0	317.0	1.12	1.12	19.80
4	3.06	3.06	97.40	320.0	322.0	1.13	1.13	19.90
5	3.24	3.24	103.90	320.0	322.0	1.12	1.13	19.80
6	3.38	3.38	109.00	321.0	329.0	1.12	1.12	19.70
7	3.08	3.09	98.20	332.0	322.0	1.13	1.14	20.10
8	3.30	3.30	106.10	319.0	321.0	1.13	1.12	19.70
9	3.33	3.33	107.10	326.0	330.0	1.11	1.12	19.80
10	3.48	3.48	112.50	317.0	321.0	1.12	1.13	19.80
11	3.15	3.14	100.10	331.0	332.0	1.13	1.13	19.90
12	3.11	3.11	99.10	329.0	326.0	1.11	1.11	20.90

TEST ITEM	DIMENSION A	DIMENSION B	DIMENSION C	DIMENSION D	DIMENSION E	DIMENSION F	DIMENSION G	DIMENSION H
UNIT	mm	mm	mm	mm	mm	mm	mm	mm
TEST CONDITOOON	/	/	/	/	/	/	/	/
SPEC	55.5MAX	29.5MAX	14.0MAX	23.3±0.5	4.0±0.5	17.0±0.5	14.2±0.5	15.38±0.5
1	54.17	28.80	12.78	23.41	4.01	16.98	14.41	15.41
2	54.44	28.80	12.80	23.37	4.07	16.87	14.09	15.52
3	54.48	28.75	12.83	23.36	4.09	17.04	14.12	15.51
4	54.03	28.85	12.74	23.34	4.02	16.94	14.27	15.30
5	54.50	28.80	12.88	23.39	4.15	16.87	14.20	15.34
6	54.19	28.60	12.69	23.37	4.05	16.96	14.28	15.56
7	54.42	28.80	12.83	23.39	4.00	17.05	14.22	15.40
8	54.47	28.81	12.83	23.38	4.04	17.00	14.23	15.24
9	54.50	28.78	12.88	23.38	4.18	16.79	14.10	15.41
10	54.42	28.76	12.85	23.34	4.01	16.88	14.15	15.34
11	54.51	28.78	12.86	23.39	4.03	16.77	14.13	15.55
12	54.49	28.75	12.81	23.39	4.14	16.96	14.17	15.40

INSPECTION ITEM		AOL	RESULT	USION  ACCEPTED REJECTED  WE CERTEIFY THAT ALL PRODUCTS HAD PASSED HI-POT TEST.
1	IR	Maj	/	
2	ELEC.CHARATERISTICS	Maj	OK	
3	MECHANICAL DIMENSION	Maj	OK	
4	APPEARANCE	Min	OK	
5	MARKING TMS92515CT . B 12TM22A	Maj	OK	
6	TERMINAL PULL TEST	Min	/	
7	OPERATING TORQUE	Maj	/	
8	SOLDERABILITY	Maj	/	
9	PACKING	Maj	OK	
10	HI-POT: P-S 2.0KVac 3mA 2S	Cri	OK	
	P-C 2.0KVac 3mA 2S	Cri	OK	
	S-C 3.5KVac 3mA 2S	Cri	OK	
Checked By		Prepared By		TEST CONDITION TEMPERATURE 26°C HUMIDITY: 70%RH

# Transformer

Model:TMS92903CT

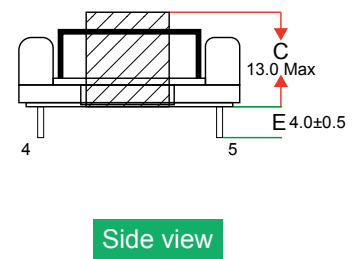
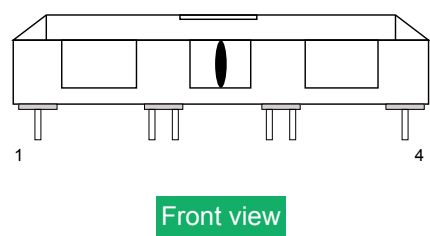
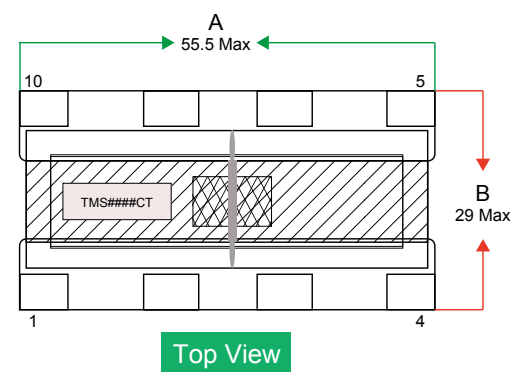
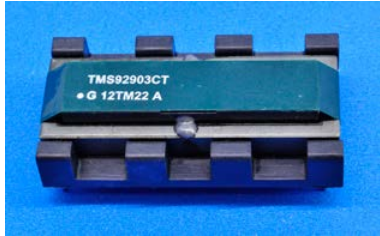

## Test data—inspection report

TEST ITEM	L(6,7-8,9)	L(1-2)	L(4-3)	LK(1-2)	LK(4-3)
UNIT	uH	H	H	mH	mH
TEST CONDITOOON	1KHZ, 1V	1KHZ, 1V	1KHZ, 1V	10KHZ, 1V short pri	10KHZ, 1V short pri
SPEC	50.0MIN	2.01MIN	2.01MIN	360.0±10%	360.0±10%
1	74.46	2.93	2.93	361	360
2	96.75	3.74	3.74	359	358
3	89.47	3.48	3.48	359	365
4	76.21	3.00	3.00	350	362
5	86.29	3.38	3.39	358	360
6	75.37	2.99	3.00	363	357
7	83.88	3.27	3.29	355	363
8	56.04	2.30	2.29	351	350
9	80.96	3.15	3.15	358	356
10	88.82	3.46	3.45	362	368
11	75.31	2.95	2.95	352	353
12	85.64	3.32	3.33	349	354

TEST ITEM	DCR(1-2)	DCR(4-3)	DCR(6,7-8,9)	DIMENSION A	DIMENSION B	DIMENSION C	DIMENSION D	DIMENSION E
UNIT	KΩ	KΩ	mΩ	mm	mm	mm	mm	mm
TEST CONDITOOON	/	/	/	/	/	/	/	/
SPEC	1.30~1.73	1.30~1.73	28.3MAX	55.5MAX	29.5MAX	14.0MAX	23.3±0.5	4.0±0.5
1	1.40	1.41	18.32	54.11	28.65	12.72	23.33	4.09
2	1.37	1.38	20.09	54.25	28.75	12.81	23.46	4.04
3	1.37	1.38	21.64	54.21	28.79	12.72	23.30	3.96
4	1.41	1.41	19.66	54.34	28.78	12.62	23.36	3.98
5	1.42	1.42	19.45	54.16	28.78	12.60	23.48	4.05
6	1.35	1.35	19.57	54.38	28.76	12.61	23.25	3.99
7	1.36	1.37	20.18	54.29	28.67	12.62	23.27	3.99
8	1.37	1.38	20.54	54.35	28.75	12.77	23.44	4.09
9	1.45	1.45	21.10	54.44	28.72	12.71	23.32	4.03
10	1.37	1.37	20.43	54.20	28.78	12.60	23.28	4.00
11	1.38	1.38	22.20	54.34	28.78	12.61	23.37	3.96
12	1.40	1.40	20.07	54.37	28.69	12.63	23.31	3.98

INSPECTION ITEM		AOL	RESULT	USION  ACCEPTED REJECTED  WE CERTEIFY THAT ALL PRODUCTS HAD PASSED HI-POT TEST.
1	IR	Maj	/	
2	ELEC.CHARATERISTICS	Maj	OK	
3	MECHANICAL DIMENSION	Maj	OK	
4	APPEARANCE	Min	OK	
5	MARKING TMS92903CT G 12TM22 A	Maj	OK	
6	TERMINAL PULL TEST	Min	/	
7	OPERATING TORQUE	Maj	/	
8	SOLDERABILITY	Maj	/	
9	PACKING	Maj	OK	
10	HI-POT: P-S 2.0KVac 3mA 2S	Cri	OK	
	P-C 2.0KVac 3mA 2S	Cri	OK	
	S-C 3.5KVac 3mA 2S	Cri	OK	
Checked By		Prepared By		TEST CONDITION TEMPERATURE 27°C HUMIDITY: 60%RH

# Transformer

Model:TMS92920CT

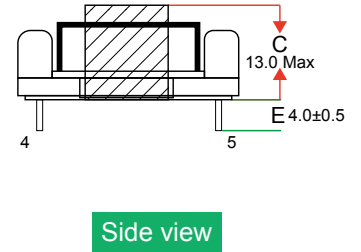
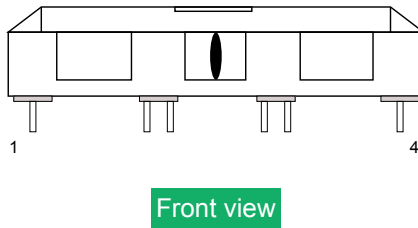
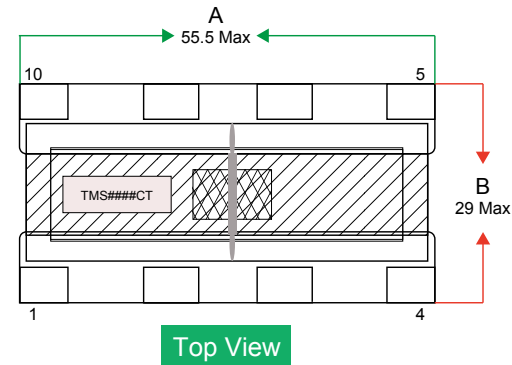

## Test data—inspection report

TEST ITEM	L(1-2)	L(4-3)	L(6,7-8,9)	LK(1-2)	LK(4-3)
UNIT	H	H	uH	mH	mH
TEST CONDITioon	1KHZ, 1V	1KHZ, 1V	1KHZ, 1V	10KHZ, 1V short pri	10KHZ, 1V short pri
SPEC	1.32MIN	1.32MIN	36.0MIN	315.0±10%	315.0±10%
1	2.22	2.23	56.30	326.0	322.0
2	2.64	2.65	68.40	321.0	322.0
3	2.50	2.51	64.50	324.0	323.0
4	2.39	2.41	61.40	326.0	323.0
5	2.29	2.29	58.40	326.0	325.0
6	2.20	2.20	55.70	331.0	325.0
7	2.56	2.58	66.50	326.0	327.0
8	2.47	2.49	63.60	324.0	327.0
9	2.40	2.40	61.60	326.0	328.0
10	2.57	2.57	66.20	328.0	322.0
11	2.40	2.41	61.50	325.0	322.0
12	2.07	2.09	52.20	322.0	327.0

TEST ITEM	DCR(1-2)	DCR(4-3)	DCR(6,7-8,9)	DIMENSION A	DIMENSION B	DIMENSION C	DIMENSION D	DIMENSION E
UNIT	Ω	Ω	mΩ	mm	mm	mm	mm	mm
TEST CONDITOOON	/	/	/	/	/	/	/	/
SPEC	900~1100	900~1100	30.0MAX	55.5MAX	29.5MAX	14.0MAX	23.3±0.5	4.0±0.5
1	988	990	19.70	54.40	28.69	12.70	23.33	3.94
2	1007	1005	17.00	54.30	28.67	12.69	23.30	3.94
3	1018	1017	19.20	54.23	28.64	12.68	23.29	3.91
4	1002	1001	18.60	54.37	28.71	1.71	23.21	4.06
5	1005	1007	20.00	54.17	28.62	12.71	23.21	3.98
6	1003	1006	16.50	54.22	28.60	12.74	23.29	3.97
7	989	991	24.50	54.31	28.67	12.71	23.26	3.99
8	990	994	22.70	54.42	28.65	12.71	23.23	4.01
9	1001	1000	17.70	54.11	28.68	12.67	23.30	3.94
10	989	992	16.20	54.08	28.70	12.73	23.27	3.98
11	1023	1026	19.70	54.15	28.60	12.71	23.25	3.93
12	989	991	19.30	54.40	28.67	12.70	23.28	3.96

INSPECTION ITEM		AOL	RESULT	USION  ACCEPTED REJECTED  WE CERTEIFY THAT ALL PRODUCTS HAD PASSED HI-POT TEST.
1	IR	Maj	/	
2	ELEC.CHARATERISTICS	Maj	OK	
3	MECHANICAL DIMENSION	Maj	OK	
4	APPEARANCE	Min	OK	
5	MARKING TMS92920CT . C 12TM22 A	Maj	OK	
6	TERMINAL PULL TEST	Min	/	
7	OPERATING TORQUE	Maj	/	
8	SOLDERABILITY	Maj	/	
9	PACKING	Maj	OK	
10	HI-POT: P-S 2.0KVac 3mA 2S	Cri	OK	
	P-C 2.0KVac 3mA 2S	Cri	OK	
	S-C 3.5KVac 3mA 2S	Cri	OK	
Checked By		Prepared By		TEST CONDITION TEMPERATURE 25°C HUMIDITY: 72%RH

# Transformer

Model:TMS92976CT

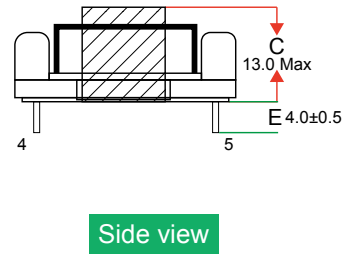
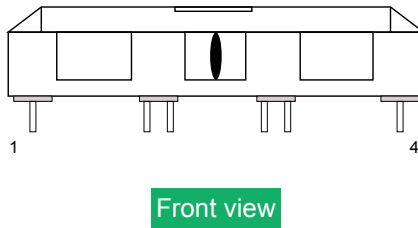
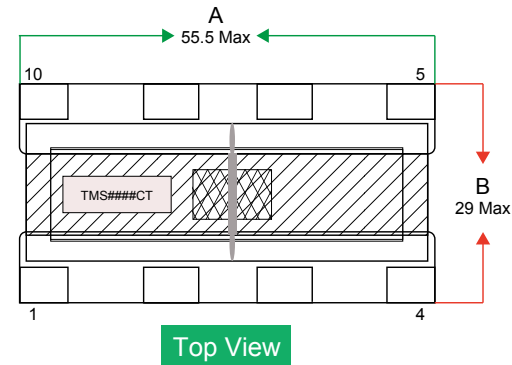
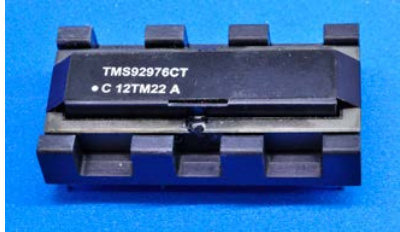

## Test data—inspection report

TEST ITEM	L(1-2)	L(3-4)	L(6,7-8,9)	DCR(1-2)	DCR(3-4)	DCR(6,7-8,9)	LK(1-2)	LK(3-4)
UNIT	H	H	uH	KΩ	KΩ	mΩ	mH	mH
TEST CONDITOOON	1KHZ, 1V	1KHZ, 1V	1KHZ, 1V	/	/	/	50KHZ,1V short pin	50KHZ,1V short pin
SPEC	1.80MIN	1.80MIN	70.0MIN	0.75~0.945	0.75~0.945	24 Max	340±10%	340±10%
1	2.86	2.86	101.80	0.790	0.790	20.20	330	335
2	2.79	2.80	99.20	0.790	0.790	21.00	328	332
3	3.16	3.16	113.40	0.800	0.800	21.70	332	333
4	2.54	2.54	88.30	0.790	0.790	21.40	330	332
5	2.78	2.78	98.20	0.800	0.800	21.00	324	325
6	2.92	2.93	104.30	0.800	0.800	21.10	326	330
7	2.99	2.98	106.60	0.800	0.800	21.30	327	330
8	2.79	2.81	98.90	0.800	0.800	22.00	321	333
9	2.99	2.99	106.80	0.800	0.800	20.50	327	327
10	2.90	2.90	103.30	0.800	0.800	20.70	327	330
11	2.78	2.78	98.40	0.800	0.800	19.70	331	333
12	2.99	3.00	107.90	0.800	0.800	20.60	328	335

TEST ITEM	DIMENSION A	DIMENSION B	DIMENSION C	DIMENSION D	DIMENSION E
UNIT	mm	mm	mm	mm	mm
TEST CONDITOOON	/	/	/	/	/
SPEC	55.5MAX	29.5MAX	14.0MAX	23.3±0.5	4.0±0.5
1	54.21	28.70	12.70	23.28	4.02
2	54.26	28.76	12.76	23.45	3.92
3	54.37	28.77	12.78	23.38	4.22
4	54.25	28.61	12.70	23.28	4.25
5	54.21	28.56	12.73	23.31	4.25
6	54.30	28.76	12.65	23.36	3.92
7	54.17	28.69	12.67	23.28	4.27
8	54.18	28.70	12.66	23.12	4.08
9	54.31	28.68	12.72	23.27	4.17
10	54.11	28.61	12.71	23.26	4.30
11	54.10	28.65	12.61	23.35	4.15
12	54.18	28.71	12.69	23.25	4.17

INSPECTION ITEM		AOL	RESULT	USION  ACCEPTED  REJECTED  WE CERTEIFY THAT ALL PRODUCTS HAD PASSED HI-POT TEST.
1	IR	Maj	/	
2	ELEC.CHARATERISTICS	Maj	OK	
3	MECHANICAL DIMENSION	Maj	OK	
4	APPEARANCE	Min	OK	
5	MARKING TMS92976CT . C 12TM22 A	Maj	OK	
6	TERMINAL PULL TEST	Min	/	
7	OPERATING TORQUE	Maj	/	
8	SOLDERABILITY	Maj	/	
9	PACKING	Maj	OK	
10	HI-POT: P-S 2.0KVac 2S 3mA MAX	Cri	OK	
	P-C 2.0KVac 2S 3mA MAX	Cri	OK	
	S-C 3.5KVac 2S 3mA MAX	Cri	OK	
Checked By		Prepared By		TEST CONDITION TEMPERATURE 24 °C HUMIDITY: 68%RH



# Transformer

Model:TMS94207CT

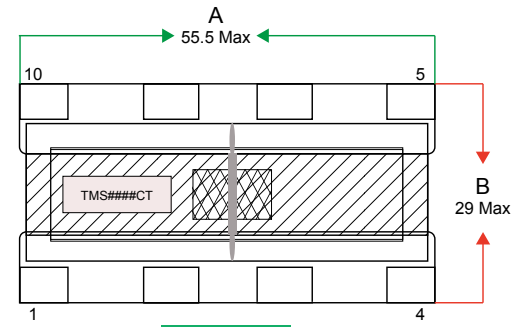

Top View

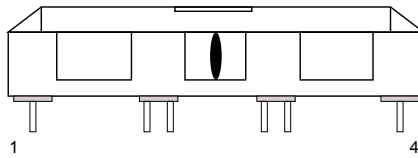

Front view

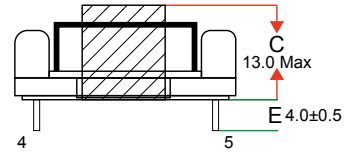

Side view

## Test data—inspection report

TEST ITEM	L(1-2)	L(4-3)	L(6,7-8,9)	LK <sub>1</sub> (1-2)	LK <sub>2</sub> (4-3)
UNIT	H	H	uH	mH	mH
TEST CONDITOOON	1KHZ, 1V	1KHZ, 1V	1KHZ, 1V	10KHZ, 1V short6-7-8-9	10KHZ, 1V short6-7-8-9
SPEC	1.2MIN	1.2MIN	28.8MIN	330±10%	330±10%
1	2.06	2.05	50.14	342.0	333.0
2	2.36	2.32	57.90	334.0	329.0
3	2.45	2.46	61.50	336.0	333.0
4	2.53	2.56	63.40	332.0	336.0
5	2.18	2.18	53.30	333.0	335.0
6	2.61	2.61	65.10	338.0	331.0
7	2.54	2.54	63.60	340.0	331.0
8	2.53	2.57	63.70	334.0	335.0
9	2.58	2.57	64.80	334.0	334.0
10	3.29	3.28	84.70	334.0	331.0
11	2.45	2.48	61.50	332.0	338.0
12	2.48	2.49	62.10	335.0	336.0

TEST ITEM	DCR(1-2)	DCR(4-3)	DCR(6,7-8,9)	DIMENSION A	DIMENSION B	DIMENSION C	DIMENSION D	DIMENSION E
UNIT	KΩ	KΩ	mΩ	mm	mm	mm	mm	mm
TEST CONDITOOON	/	/	/	/	/	/	/	/
SPEC	1.0~1.4	1.0~1.4	42MAX	55.5MAX	29.5MAX	14.0MAX	23.3±0.5	4.0±0.5
1	1.13	1.13	23.50	54.39	28.68	12.71	23.17	3.90
2	1.11	1.11	18.26	54.40	28.72	12.76	23.27	4.18
3	1.11	1.11	19.54	54.57	28.72	12.74	23.25	4.19
4	1.10	1.10	18.44	54.45	28.75	12.74	23.21	4.15
5	1.11	1.11	17.65	54.35	28.82	12.76	23.36	4.18
6	1.12	1.12	17.75	54.27	28.60	12.60	23.30	4.16
7	1.12	1.12	17.76	54.40	28.80	12.77	23.58	4.10
8	1.11	1.10	19.25	54.57	28.83	12.83	23.22	4.09
9	1.11	1.11	20.48	54.44	28.72	12.67	23.20	3.96
10	1.10	1.10	20.47	54.40	28.78	12.70	23.32	4.01
11	1.10	1.10	21.38	54.34	28.75	12.73	23.12	4.10
12	1.13	1.13	17.54	54.49	28.78	12.72	23.09	4.06

INSPECTION ITEM		AOL	RESULT	USION  ACCEPTED REJECTED  WE CERTEIFY THAT ALL PRODUCTS HAD PASSED HI-POT TEST.
1	IR	Maj	/	
2	ELEC.CHARATERISTICS	Maj	OK	
3	MECHANICAL DIMENSION	Maj	OK	
4	APPEARANCE	Min	OK	
5	MARKING TMS94207CT . B 12TM 22A	Maj	OK	
6	TERMINAL PULL TEST	Min	/	
7	OPERATING TORQUE	Maj	/	
8	SOLDERABILITY	Maj	/	
9	PACKING	Maj	OK	
10	HI-POT: P-S 2.0KVac 3mA 2Sec	Cri	OK	
	P-C 2.0KVac 3mA2Sec	Cri	OK	
	S-C 3.5KVac 3mA 2Sec	Cri	OK	
Checked By		Prepared By		TEST CONDITION TEMPERATURE 26°C HUMIDITY: 65%RH

# Transformer

Model:TMS94481CT

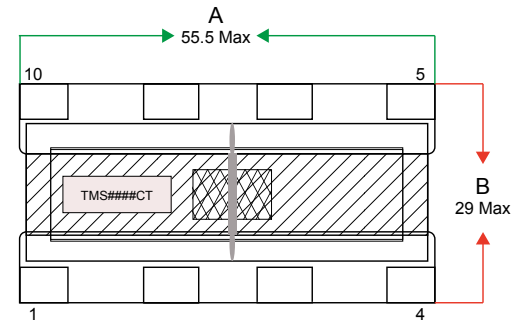
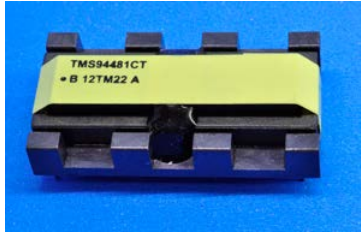

Top View

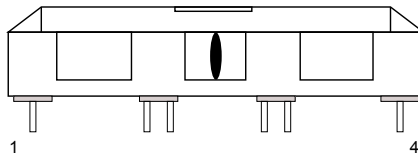

Front view

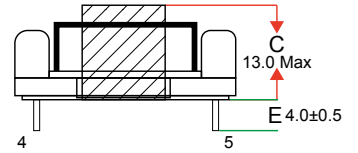

Side view

## Test data—inspection report

TEST ITEM	L(1-2)	L(4-3)	L(6,7-8,9)	LK(1-2)	LK(4-3)	DCR(1-2)	DCR(4-3)	DCR(6,7-8,9)
UNIT	H	H	uH	mH	mH	KΩ	KΩ	mΩ
TEST CONDITOOON	1KHZ, 1V	1KHZ, 1V	1KHZ, 1V	50KHZ, 1V short pri	50KHZ, 1V short pri	/	/	/
SPEC	1.4MIN	1.4MIN	116MIN	280.0±10%	280.0±10%			
MAX				308	308	1.105	1.105	46.00
MIN	1.4	1.4	116	252	252	0.860	0.860	
1	1.97	1.96	151.10	282	283	1.00	1.00	39.70
2	1.86	1.87	141.30	291	290	0.99	0.99	40.50
3	1.85	1.85	139.80	291	291	0.97	0.97	40.20
4	1.92	1.96	148.20	286	292	0.98	0.98	40.40
5	1.98	1.99	152.80	286	285	0.98	0.98	40.50
6	2.14	2.13	163.70	290	294	1.01	1.01	42.10
7	1.93	1.93	146.20	293	293	0.97	0.97	40.50
8	1.93	1.92	146.90	285	285	0.99	0.99	39.40
9	2.06	2.09	161.50	286	286	0.98	0.98	39.20
10	2.08	2.03	160.00	287	287	0.97	0.97	41.00
11	1.96	1.96	149.70	293	293	0.96	0.96	39.90
12	2.09	2.09	161.00	291	291	0.98	0.97	41.00
Average	1.98	1.98	151.85	288	289	0.98	0.98	40.37
Judgment	OK	OK	OK	OK	OK	OK	OK	OK

TEST ITEM	DIMENSION A	DIMENSION B	DIMENSION C	DIMENSION D	DIMENSION E
UNIT	mm	mm	mm	mm	mm
TEST	/	/	/	/	/
CONDITOOON					
SPEC	54.3±0.5	28.7±0.5	12.6±0.5	23.3±0.5	4.0±0.5
USL	54.8	29.2	13.1	23.8	4.5
LSL	53.8	28.2	12.1	22.8	3.5
1	54.46	28.83	12.58	23.19	4.11
2	54.41	28.78	12.56	23.22	4.18
3	54.38	28.79	12.61	23.20	4.12
4	54.37	28.77	12.56	23.23	4.19
5	54.40	28.74	12.57	23.23	4.11
6	54.36	28.81	12.62	23.19	4.17
7	54.41	28.83	12.62	23.26	4.18
8	54.39	28.80	12.58	23.20	3.99
9	54.36	28.79	12.60	23.27	4.06
10	54.40	28.74	12.55	23.22	4.03
11	54.38	28.84	12.57	23.24	4.08
12	54.40	28.86	12.60	23.27	4.16
Average	54.39	28.80	12.59	23.23	4.12
Judgment	OK	OK	OK	OK	OK

INSPECTION ITEM		AOL	RESULT	USION  ACCEPTED REJECTED  WE CERTEIFY THAT ALL PRODUCTS HAD PASSED HI-POT TEST.
1	IR	Maj	OK	
2	ELEC.CHARATERISTICS	Maj	OK	
3	MECHANICAL DIMENSION	Maj	OK	
4	APPEARANCE	Min	OK	
5	MARKING TMS94481CT . B 12TM22A	Maj	OK	
6	TERMINAL PULL TEST	Min	/	
7	OPERATING TORQUE	Maj	/	
8	SOLDERABILITY	Maj	/	
9	PACKING	Maj	OK	
10	HI-POT: P-S 2.0KVac 3mA 2S P-C 2.0KVac 3mA 2S S-C 3.5KVac 3mA2S	Cri Cri Cri	OK OK OK	
Checked By		Prepared By		TEST CONDITION TEMPERATURE 20°C HUMIDITY: 50%RH

# Transformer

Model:TMS94819CT

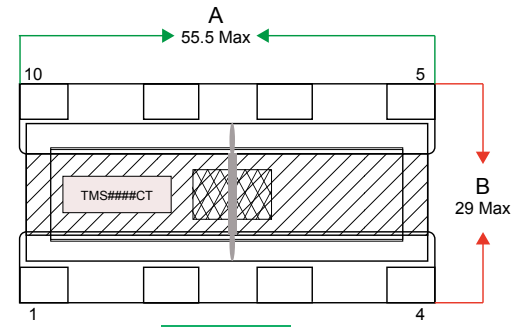
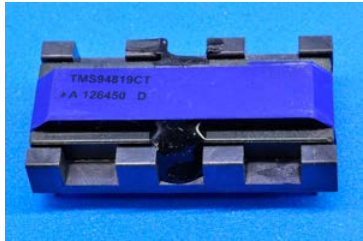

Top View

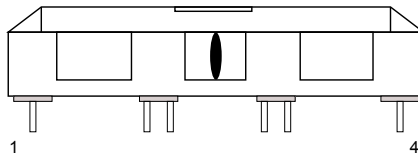

Front view

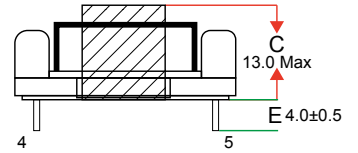

Side view

## Test data—inspection report

TEST ITEM	L(1-2)	L(4-3)	L(6,7-8,9)	LK(1-2)	LK(4-3)	DCR(1-2)	DCR(4-3)	DCR (6,7-8,9)
UNIT	H	H	uH	mH	mH	kΩ	kΩ	mΩ
TEST	1KHZ, 1V	1KHZ, 1V	1KHZ, 1V	10KHZ, 1V short pri	10KHZ, 1V short pri	/	/	/
CONDITION								
SPEC	1.8MIN	1.8MIN	45.0MIN	360.0±10%	360.0±10%	1.3~1.73	1.3~1.73	28.3MAX
MAX				396.0	396.0	1.73	1.73	28.30
MIN	1.80	1.80	45.00	324.0	324.0	1.30	1.30	
1	2.85	2.85	70.90	363	360	1.45	1.45	17.80
2	3.16	3.14	79.20	363	362	1.45	1.45	17.50
3	2.68	2.69	66.10	362	358	1.45	1.45	18.70
4	3.01	2.99	74.80	364	360	1.45	1.45	18.80
5	2.50	2.51	60.80	358	360	1.45	1.45	18.90
6	2.53	2.54	61.50	363	359	1.46	1.46	17.30
7	2.48	2.50	60.50	363	363	1.46	1.46	17.20
8	2.95	2.94	73.40	361	361	1.44	1.44	17.00
9	2.74	2.73	67.40	361	358	1.44	1.44	17.40
10	2.64	2.65	64.90	363	363	1.46	1.46	17.80
11	2.93	2.89	72.30	363	360	1.45	1.45	17.90
12	2.85	2.84	70.90	364	364	1.46	1.46	17.30
Average	2.78	2.77	68.56	362	361	1.45	1.45	17.80
Judgment	OK	OK	OK	OK	OK	OK	OK	OK

TEST ITEM	DIMENSION A	DIMENSION B	DIMENSION C	DIMENSION D	DIMENSION E	Striking Voltage(1-2/4-3)
UNIT	mm	mm	mm	mm	mm	KV
TEST CONDITION	/	/	/	/	/	/
SPEC	55.5MAX	29.5MAX	14.0MAX	23.3±0.3	4.0±0.5	2.1
USL	55.500	29.5	14.0	23.60	4.50	
LSL				23.00	3.50	
1	54.42	28.69	12.53	23.13	3.92	OK
2	54.42	28.70	12.52	23.21	4.12	OK
3	54.42	28.62	12.54	23.16	4.13	OK
4	54.42	28.68	12.52	23.18	4.05	OK
5	54.49	28.65	12.51	23.20	4.13	OK
6	54.43	28.72	12.60	23.24	4.09	OK
7	54.51	28.71	12.54	23.20	4.08	OK
8	54.47	28.69	12.66	23.18	4.11	OK
9	54.40	28.61	12.57	23.20	4.04	OK
10	54.42	28.71	12.55	23.24	4.08	OK
11	54.34	28.70	12.54	23.19	3.97	OK
12	54.40	28.69	12.52	23.17	4.07	OK
Average	54.43	28.68	12.55	23.19	4.07	
Judgment	OK	OK	OK	OK	OK	

INSPECTION ITEM		AOL	RESULT	USION  ACCEPTED REJECTED  WE CERTEIFY THAT ALL PRODUCTS HAD PASSED HI-POT TEST.
1	IR	Maj	OK	
2	ELEC.CHARATERISTICS	Maj	OK	
3	MECHANICAL DIMENSION	Maj	OK	
4	APPEARANCE	Min	OK	
5	MARKING TMS94819CT . A 126450 D	Maj	OK	
6	TERMINAL PULL TEST	Min	/	
7	OPERATING TORQUE	Maj	/	
8	SOLDERABILITY	Maj	/	
9	PACKING	Maj	OK	
10	HI-POT: P-S 2.0KVac 3mA 2S 50Hz	Cri	OK	
	P-C 2.0KVac 3mA 2S 50Hz	Cri	OK	
	S-C 3.5KVac 3mA 2S 50Hz	Cri	OK	
Checked By		Prepared By		TEST CONDITION TEMPERATURE 25°C HUMIDITY: 70%RH