

DESCRIPTION

The MP6215 Power Distribution Switch features internal current limiting to prevent damage to host devices due to faulty load conditions. The MP6215 operates from a 3.3V or 5V nominal input voltage and includes a 90 mΩ Power MOSFET to handle up to 1.5A continuous load with a 2.3A typical current limit. The MP6215 has built-in protection for both over current and increased thermal stress. For over-current protection (OCP), the device will limit the current by going into a constant current mode.

When continuous output overload condition exceeds power dissipation of the package, the thermal protection will shut the part off. The device will recover once the device temperature reduces to approx 120°C.

The MP6215 is available in an MSOP8 package with exposed pad.

FEATURES

- 1.5A Continuous Current
- Accurate Current Limit
- 2.7V to 5.5V Supply Range
- 140uA Quiescent Current
- Thermal-Shutdown Protection
- Under-Voltage Lockout
- 8ms FLAG Deglitch Time
- No FLAG Glitch During Power Up
- Reverse Current Blocking

APPLICATIONS

- Notebook PC
- Set-top-box
- Telecom and Network Systems
- PC Card Hot Swap
- USB Power Distribution

"MPS" and "The Future of Analog IC Technology" are Trademarks of Monolithic Power Systems, Inc.

TYPICAL APPLICATION

3.3V / 5V Input

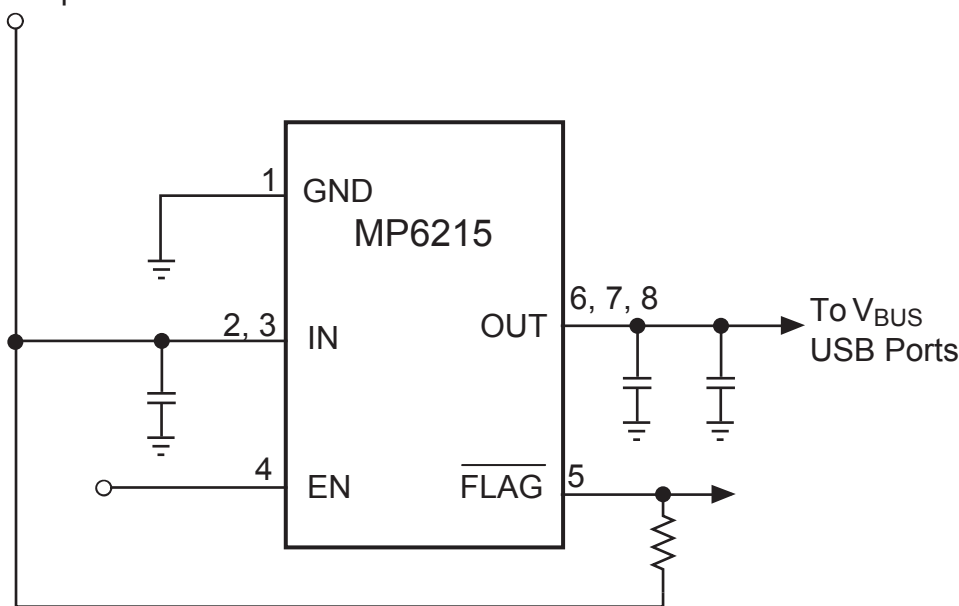

SINGLE-CHANNEL

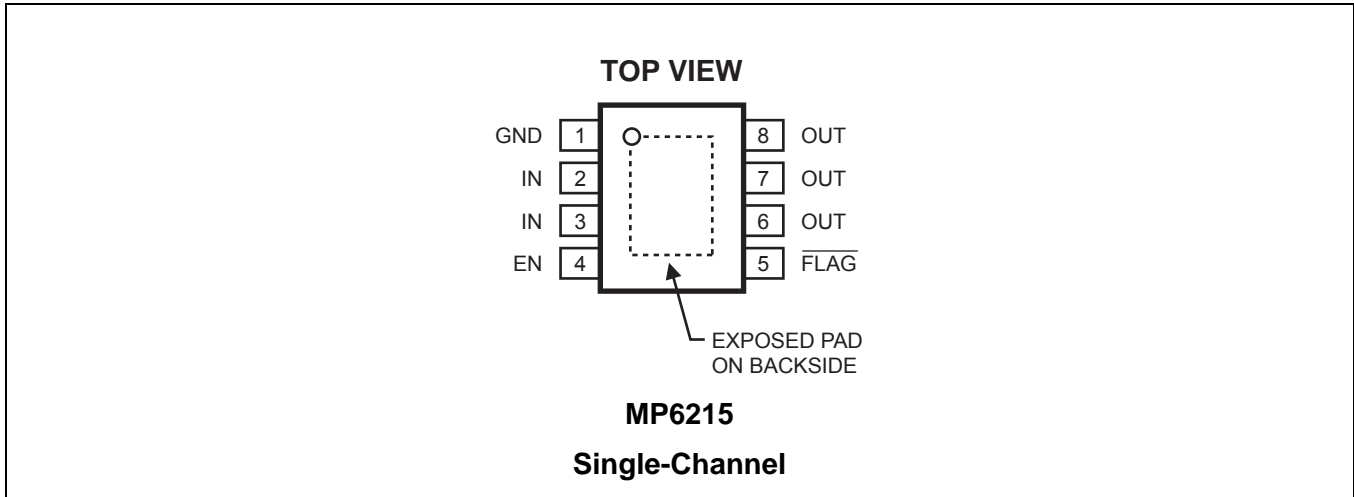
PACKAGE REFERENCE

Part Number	Enable	Switch	Maximum Continuous Load Current	Typical Short-Circuit Current @ T _A =25C	Package	Temperature
MP6215DH	Active High	Single	1.5A	2.3A	MSOP8 (EP)	-40°C to +85°C

* For Tape & Reel, add suffix -Z (eg. MP6215DH-Z)
For RoHS Compliant Packaging, add suffix -LF
(eg. MP6215DH-LF-Z)

ABSOLUTE MAXIMUM RATINGS ⁽¹⁾

IN-0.3V to +6.5V
ON, FLAG, OUT to GND.....-0.3V to +6.5V
Junction Temperature 150°C
Lead Temperature260°C
Storage Temperature.....-65°C to +150°C
Operating Temperature.....-40°C to +85°C

Thermal Resistance ⁽²⁾ θ_{JA} θ_{JC}
MSOP8E..... 55..... 12... °C/W

Notes:

- 1) Exceeding these ratings may damage the device.
- 2) Measured on JESD51-7, 4-layer PCB..

ELECTRICAL CHARACTERISTICS ⁽³⁾
 $V_{IN}=5V$, $T_A=+25^{\circ}C$, unless otherwise noted.

Parameter	Condition	Min	Typ	Max	Units
IN Voltage Range	2.7			5.5	V
Supply Current	EN=High, $I_{OUT}=0$		140	160	μA
Shutdown Current	Device Disable, $V_{OUT}=\text{float}$, $V_{IN}=5.5V$		1		μA
Off Switch Leakage	Device Disable, $V_{IN}=5.5V$		1		μA
Current Limit	1.6		2.3	3.0	A
Under-voltage Lockout	Rising Edge	1.95		2.65	V
Under-voltage Hysteresis			250		mV
FET On Resistance	$I_{OUT}=100mA$		85		$m\Omega$
EN Input Logic High Voltage	2				V
EN Input Logic Low Voltage				0.4	V
FLAG Output Logic Low Voltage	$I_{SINK}=5mA$			0.4	V
FLAG Output High Leakage Current	$V_{IN}=V_{FLAG}=5.5V$			1	μA
Thermal Shutdown			140		$^{\circ}C$
Thermal Shutdown Hysteresis			20		$^{\circ}C$
V_{OUT} Rising Time, T_r	$V_{IN}=5.5V$, $CL=1\mu F$, $RL=5\Omega$	0.9			ms
	$V_{IN}=2.7V$, $CL=1\mu F$, $RL=5\Omega$	1.7			ms
V_{OUT} Falling Time, T_f	$V_{IN}=5.5V$, $CL=1\mu F$, $RL=5\Omega$			0.5	ms
	$V_{IN}=2.7V$, $CL=1\mu F$, $RL=5\Omega$			0.5	ms
Turn On Time, T_{on}	$C_L=100\mu F$, $RL=5\Omega$			3	ms
Turn Off Time, T_{off}	$C_L=100\mu F$, $RL=5\Omega$			10	ms
FLAG Deglitch Time		4	8	15	ms
EN Input Leakage	-1				μA
Reverse Leakage Current	$OUT=5.5V$, $IN=GND$		0.2		μA

NOTE:

 3) Production test at $+25^{\circ}C$. Specifications over the temperature range are guaranteed by design and characterization.

PIN FUNCTIONS

MSOP8E Name		Description
1	GND	Ground.
2, 3	IN	Input Voltage. Accepts 2.7V to 5.5V input.
4	EN	Active High
5	$\overline{\text{FLAG}}$	IN-to-OUT Over-current, active-low output flag. Open-Drain.
6, 7, 8	OUT	IN-to-OUT Power-Distribution Output (for all 3 output pins)

TYPICAL PERFORMANCE CHARACTERISTICS

$T_A = +25^\circ\text{C}$, unless otherwise noted.

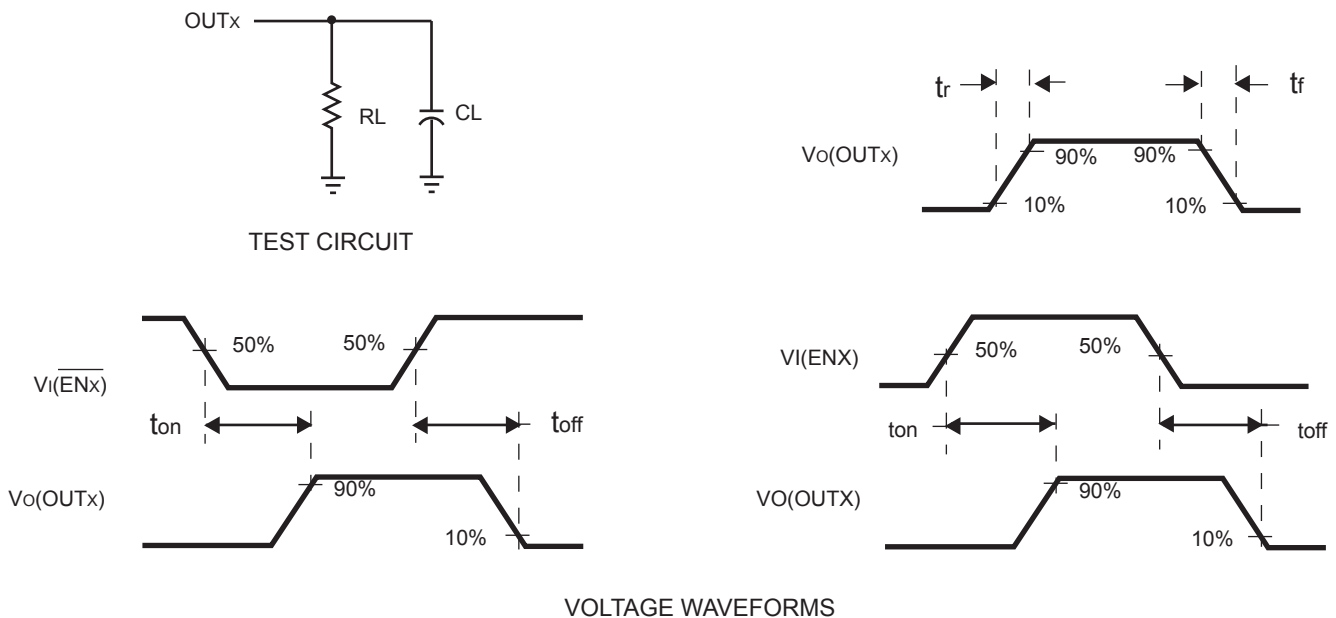

Figure 1—Test Circuit and Voltage Waveforms

TYPICAL PERFORMANCE CHARACTERISTICS

$T_A = +25^{\circ}\text{C}$, unless otherwise noted.

Turn on Delay vs. Input Voltage

$V_{EN}=5\text{V}$, $I_O=1.5\text{A}$, $C_L=2.2\mu\text{F}$

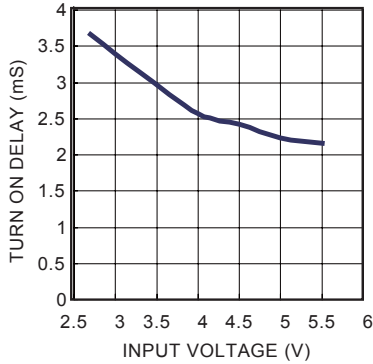

Turn off Delay vs. Input Voltage

$V_{EN}=5\text{V}$, $I_O=1.5\text{A}$, $C_L=2.2\mu\text{F}$

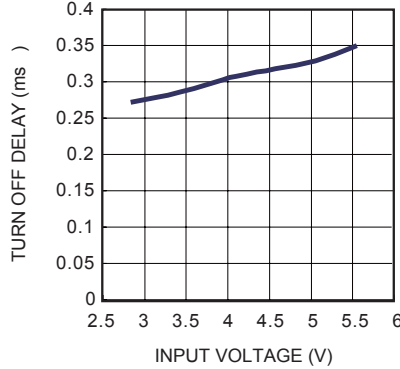

Supply Current, Output Enabled vs. Input Voltage

$V_{EN}=5\text{V}$, $C_L=2.2\mu\text{F}$

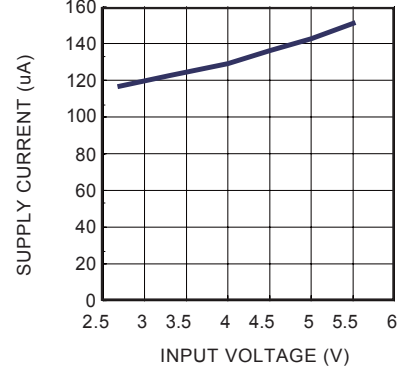

Supply Current, Output Disabled vs. Input Voltage

$V_{EN}=0\text{V}$, $C_L=2.2\mu\text{F}$

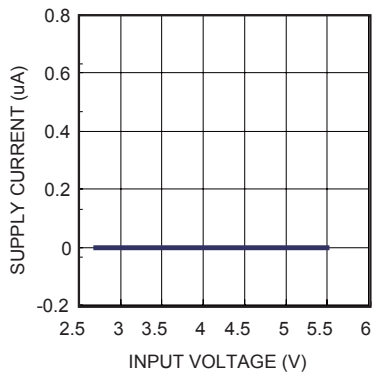

Static Drain-Source On-State Resistance vs. Input Voltage

$V_{EN}=5\text{V}$, $I_{OUT}=1.5\text{A}$, $C_L=2.2\mu\text{F}$

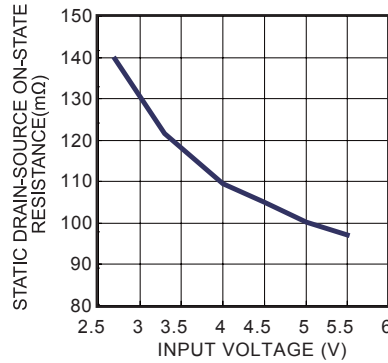

Input to Output Voltage vs. Load Current

$V_{EN}=5\text{V}$, $C_L=2.2\mu\text{F}$

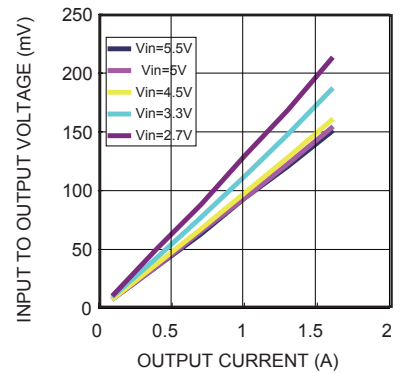

Current Limit vs. Input Voltage

$V_{EN}=5\text{V}$, $C_L=2.2\mu\text{F}$

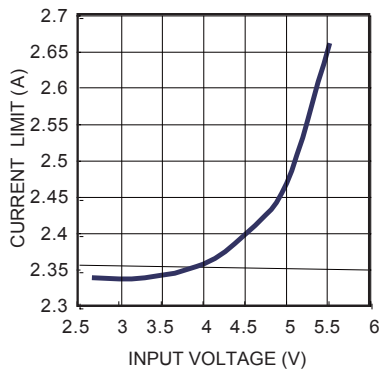

Threshold Trip Current vs. Input Voltage

$V_{EN}=5\text{V}$, $C_L=2.2\mu\text{F}$

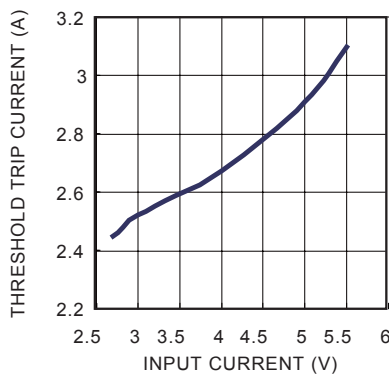

Current Limit Response Time vs. Peak Voltage

$V_{EN}=5\text{V}$, $V_{IN}=5\text{V}$, $C_L=2.2\mu\text{F}$

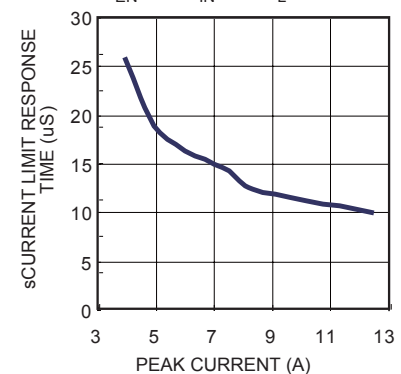

TYPICAL PERFORMANCE CHARACTERISTICS

$T_A = +25^\circ\text{C}$, unless otherwise noted. (continued)

Turn On Delay and Rise Time with 0.22 μF Load

$V_{IN}=5\text{V}$, $V_{EN}=5\text{V}$, $R_L=3.3\Omega$, $C_L=0.22\mu\text{F}$

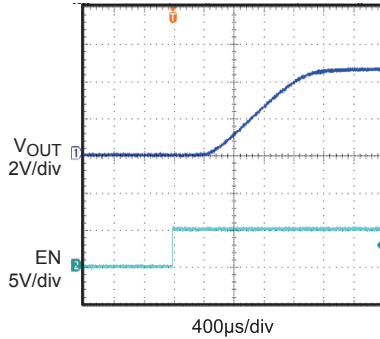

Turn Off Delay and Fall Time with 0.22 μF Load

$V_{IN}=5\text{V}$, $V_{EN}=5\text{V}$, $R_L=3.3\Omega$, $C_L=0.22\mu\text{F}$

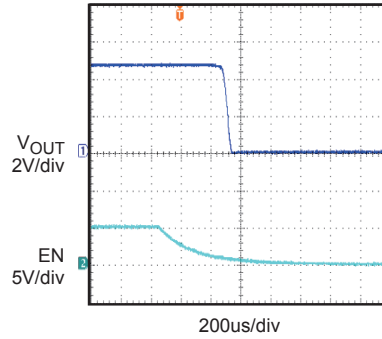

Turn On Delay and Rise Time with 2.2 μF Load

$V_{IN}=5\text{V}$, $V_{EN}=5\text{V}$, $R_L=3.3\Omega$, $C_L=2.2\mu\text{F}$

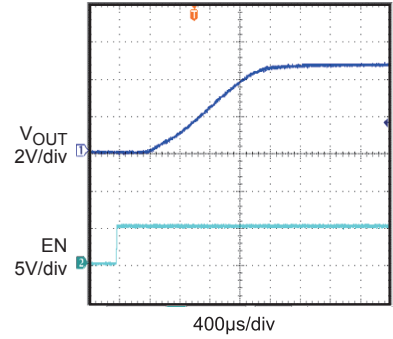

Turn Off Delay and Fall Time with 2.2 μF Load

$V_{IN}=5\text{V}$, $V_{EN}=5\text{V}$, $R_L=3.3\Omega$, $C_L=2.2\mu\text{F}$

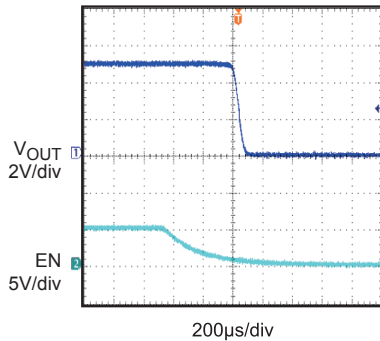

Short Circuit Current Device Enabled into Short

$V_{IN}=5\text{V}$, $V_{EN}=5\text{V}$, $C_L=2.2\mu\text{F}$

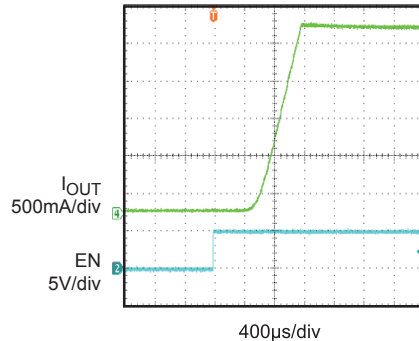

Threshold Trip Current with Ramped Load on Enabled Device

$V_{IN}=5\text{V}$, $V_{EN}=5\text{V}$, $C_L=2.2\mu\text{F}$

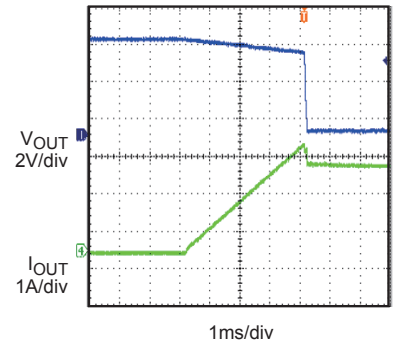

Ramped Load on Enabled Device

$V_{IN}=5\text{V}$, $V_{EN}=5\text{V}$, $C_L=2.2\mu\text{F}$

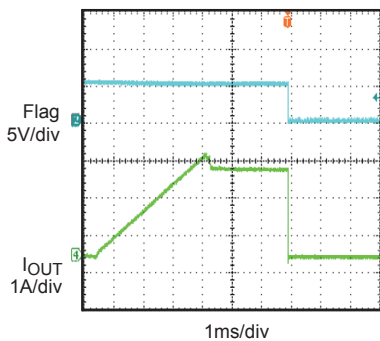

Inrush Current with Different Load Capacitance

$V_{IN}=5\text{V}$, $V_{EN}=5\text{V}$, $R_L=3.3\Omega$, Start up by EN

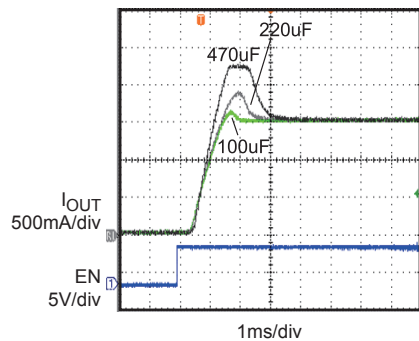

1 Ω Load Connected to Enabled Device

$V_{IN}=5\text{V}$, $V_{EN}=5\text{V}$, $C_L=2.2\mu\text{F}$

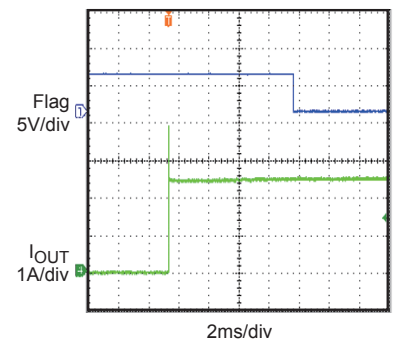

FUNCTION BLOCK DIAGRAM

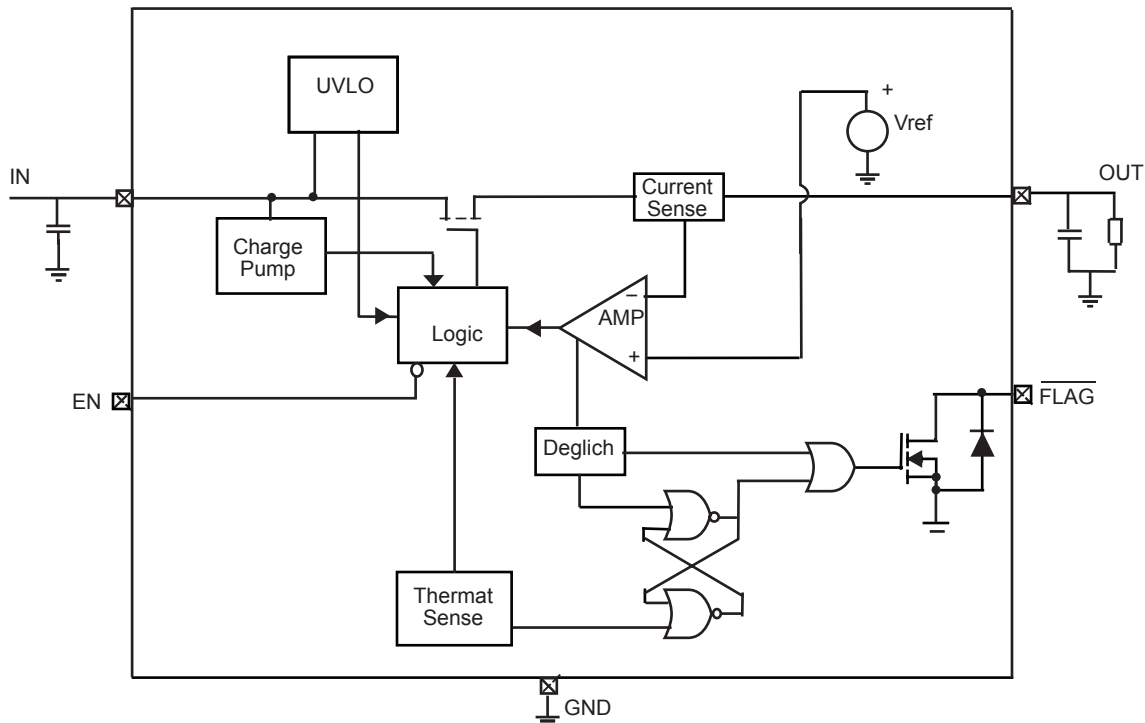

Figure2—Functional Block Diagram

DETAILED DESCRIPTION

Over Current

When the load exceeds trip current (minimum threshold current triggering constant-current mode) or a short is present, MP6215 switches into a constant-current mode (current limit value). MP6215 will be shutdown only if the overcurrent condition stays long enough to trigger thermal protection.

Trigger overcurrent protection for different overload conditions occurring in applications:

- 1) The output has been shorted or overloaded before the device is enabled or input applied. MP6215 detects the short or overload and immediately switches into a constant-current mode.
- 2) A short or an overload occurs after the device is enabled. After the current-limit circuit has been tripped (reached the trip current threshold), the device switches into constant-current mode. However, high current may flow for a short period of time before the current-limit circuit can react.

- 3) Output current has been gradually increased beyond the recommended operating current. The load current rises until the trip current threshold is reached or until the thermal limit of the device is exceeded. The MP6215 is capable of delivering current up to the trip current threshold without damaging the device. Once the trip threshold has been reached, the device switches into its constant-current mode.

Flag Response

The FLAG pin is an open drain configuration. This FAULT will report a fail mode after an 8ms deglitch timeout. This is used to ensure that no false fault signals are reported. This internal deglitch circuit eliminates the need for extended components. The FLAG pin is not deglitched during an overtemp. or a voltage lockout.

Thermal Protection

The purpose of thermal protection is to prevent damage in the IC by allowing excessive current to flow and heating the junction. The die temperature is internally monitored until the thermal limit is reached. Once this temperature is reached, the switch will turn off and allow the chip to cool. The switch has a built-in hysteresis.

Under-voltage Lockout (UVLO)

This circuit is used to monitor the input voltage to ensure that the MP6215 is operating correctly.

This UVLO circuit also ensures that the device is in operation until the input voltage reaches the minimum spec.

Enable

The logic pin disables the switch to reduce overall supply current. Once the EN pin reaches Logic HIGH, the MP6215 is enabled.

APPLICATION INFORMATION

Power-Supply Considerations

A ceramic bypass capacitor between IN and GND, close to the device, is recommended. Placing a high-value electrolytic capacitor on the output pin(s) is recommended when the output load is heavy. This precaution reduces power-supply transients that may cause ringing on the input. Optionally, bypassing the output with a ceramic capacitor improves the immunity of the device to short-circuit transients.

PACKAGE INFORMATION

MSOP8E (EXPOSED PAD)

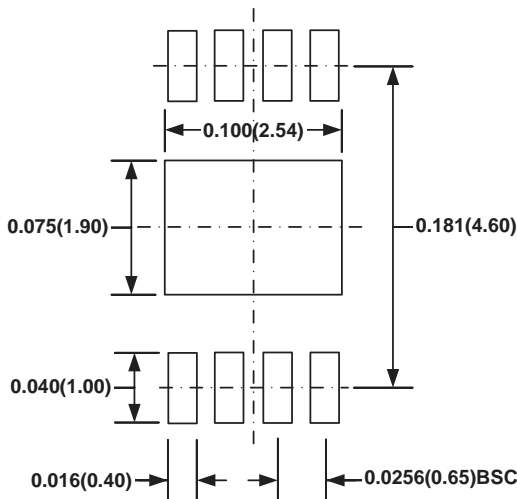
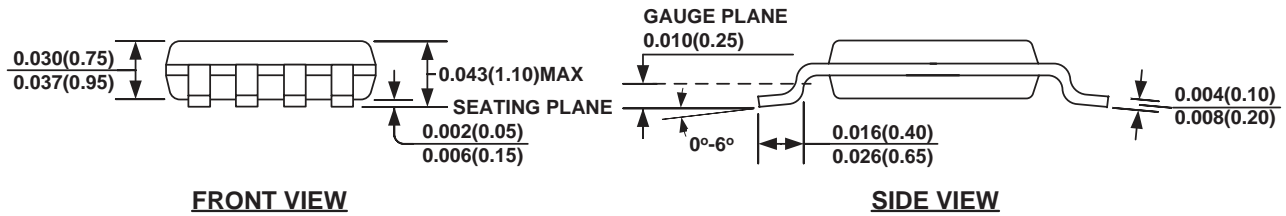
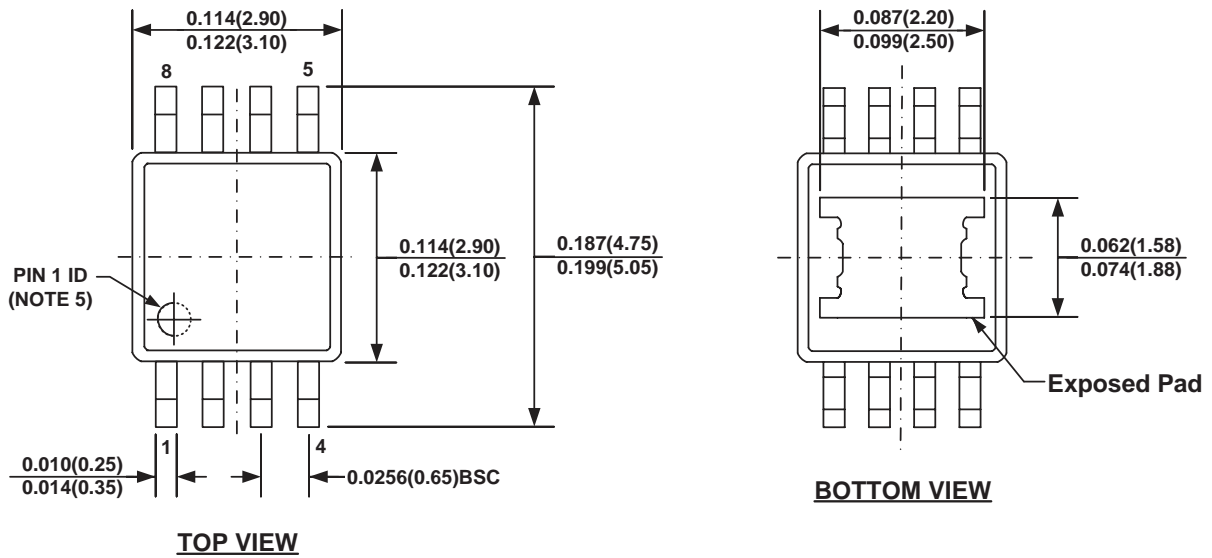

NOTE:

- 1) CONTROL DIMENSION IS IN INCHES. DIMENSION IN BRACKET IS IN MILLIMETERS.
- 2) PACKAGE LENGTH DOES NOT INCLUDE MOLD FLASH, PROTRUSION OR GATE BURR.
- 3) PACKAGE WIDTH DOES NOT INCLUDE INTERLEAD FLASH OR PROTRUSION.
- 4) LEAD COPLANARITY (BOTTOM OF LEADS AFTER FORMING) SHALL BE 0.004" INCHES MAX.
- 5) PIN 1 IDENTIFICATION HAS HALF OR FULL CIRCLE OPTION.
- 6) DRAWING MEETS JEDEC MO-187, VARIATION AA-T.
- 7) DRAWING IS NOT TO SCALE.

NOTICE: The information in this document is subject to change without notice. Users should warrant and guarantee that third party Intellectual Property rights are not infringed upon when integrating MPS products into any application. MPS will not assume any legal responsibility for any said applications.