

SEMiX453GAL12E4s



SEMiX[®] 3s

Trench IGBT Modules

SEMiX453GAL12E4s

Features

- Homogeneous Si
- Trench = Trenchgate technology
- $V_{CE(sat)}$ with positive temperature coefficient
- High short circuit capability
- UL recognized, file no. E63532

Typical Applications*

- AC inverter drives
- UPS
- Electronic Welding

Remarks

- Case temperature limited to $T_C=125^{\circ}\text{C}$ max.
- Product reliability results are valid for $T_j=150^{\circ}\text{C}$
- Dynamic values apply to the following combination of resistors:
 $R_{Gon,main} = 1,0 \Omega$
 $R_{Goff,main} = 1,0 \Omega$
 $R_{G,X} = 2,2 \Omega$
 $R_{E,X} = 0,5 \Omega$

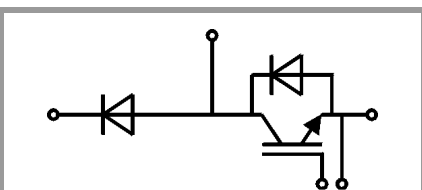

GAL

Absolute Maximum Ratings				
Symbol	Conditions		Values	Unit
IGBT				
V_{CES}			1200	V
I_C	$T_j = 175^{\circ}\text{C}$	$T_c = 25^{\circ}\text{C}$	683	A
		$T_c = 80^{\circ}\text{C}$	526	A
I_{Cnom}			450	A
I_{CRM}	$I_{CRM} = 3 \times I_{Cnom}$		1350	A
V_{GES}			-20 ... 20	V
t_{psc}	$V_{CC} = 800\text{ V}$ $V_{GE} \leq 20\text{ V}$ $V_{CES} \leq 1200\text{ V}$	$T_j = 150^{\circ}\text{C}$	10	μs
T_j			-40 ... 175	$^{\circ}\text{C}$
Inverse diode				
I_F	$T_j = 175^{\circ}\text{C}$	$T_c = 25^{\circ}\text{C}$	544	A
		$T_c = 80^{\circ}\text{C}$	407	A
I_{Fnom}			450	A
I_{FRM}	$I_{FRM} = 3 \times I_{Fnom}$		1350	A
I_{FSM}	$t_p = 10\text{ ms, sin } 180^{\circ}, T_j = 25^{\circ}\text{C}$		2430	A
T_j			-40 ... 175	$^{\circ}\text{C}$
Freewheeling diode				
I_F	$T_j = 175^{\circ}\text{C}$	$T_c = 25^{\circ}\text{C}$	544	A
		$T_c = 80^{\circ}\text{C}$	407	A
I_{Fnom}			450	A
I_{FRM}	$I_{FRM} = 3 \times I_{Fnom}$		1350	A
I_{FSM}	$t_p = 10\text{ ms, sin } 180^{\circ}, T_j = 25^{\circ}\text{C}$		2430	A
T_j			-40 ... 175	$^{\circ}\text{C}$
Module				
$I_{t(RMS)}$			600	A
T_{stg}			-40 ... 125	$^{\circ}\text{C}$
V_{isol}	AC sinus 50Hz, $t = 1\text{ min}$		4000	V

Characteristics						
Symbol	Conditions		min.	typ.	max.	Unit
IGBT						
$V_{CE(sat)}$	$I_C = 450\text{ A}$ $V_{GE} = 15\text{ V}$ chipelevel	$T_j = 25^{\circ}\text{C}$	1.8	2.05		V
		$T_j = 150^{\circ}\text{C}$	2.2	2.4		V
V_{CE0}		$T_j = 25^{\circ}\text{C}$	0.8	0.9		V
		$T_j = 150^{\circ}\text{C}$	0.7	0.8		V
r_{CE}	$V_{GE} = 15\text{ V}$	$T_j = 25^{\circ}\text{C}$	2.2	2.6		$\text{m}\Omega$
		$T_j = 150^{\circ}\text{C}$	3.3	3.6		$\text{m}\Omega$
$V_{GE(th)}$	$V_{GE} = V_{CE}, I_C = 18\text{ mA}$		5	5.8	6.5	V
I_{CES}	$V_{GE} = 0\text{ V}$ $V_{CE} = 1200\text{ V}$	$T_j = 25^{\circ}\text{C}$	0.1	0.3		mA
		$T_j = 150^{\circ}\text{C}$				mA
C_{ies}	$V_{CE} = 25\text{ V}$ $V_{GE} = 0\text{ V}$	$f = 1\text{ MHz}$		27.9		nF
C_{oes}		$f = 1\text{ MHz}$		1.74		nF
C_{res}		$f = 1\text{ MHz}$		1.53		nF
Q_G	$V_{GE} = -8\text{ V...} + 15\text{ V}$			2550		nC
R_{Gint}	$T_j = 25^{\circ}\text{C}$			1.67		Ω

SEMiX453GAL12E4s



SEMiX® 3s

Trench IGBT Modules

SEMiX453GAL12E4s

Features

- Homogeneous Si
- Trench = Trenchgate technology
- $V_{CE(sat)}$ with positive temperature coefficient
- High short circuit capability
- UL recognized, file no. E63532

Typical Applications*

- AC inverter drives
- UPS
- Electronic Welding

Remarks

- Case temperature limited to $T_C=125^\circ\text{C}$ max.
- Product reliability results are valid for $T_j=150^\circ\text{C}$
- Dynamic values apply to the following combination of resistors:
 $R_{Gon,main} = 1,0 \Omega$
 $R_{Goff,main} = 1,0 \Omega$
 $R_{G,X} = 2,2 \Omega$
 $R_{E,X} = 0,5 \Omega$

Characteristics						
Symbol	Conditions		min.	typ.	max.	Unit
$t_{d(on)}$	$V_{CC} = 600 \text{ V}$	$T_j = 150^\circ\text{C}$		336		ns
t_r	$I_C = 450 \text{ A}$	$T_j = 150^\circ\text{C}$		80		ns
E_{on}	$R_{G on} = 1.9 \Omega$	$T_j = 150^\circ\text{C}$		45		mJ
$t_{d(off)}$	$R_{G off} = 1.9 \Omega$	$T_j = 150^\circ\text{C}$		615		ns
t_f	$di/dt_{on} = 4000 \text{ A}/\mu\text{s}$	$T_j = 150^\circ\text{C}$		130		ns
E_{off}	$di/dt_{off} = 5000 \text{ A}/\mu\text{s}$	$T_j = 150^\circ\text{C}$		66.5		mJ
$R_{th(j-c)}$	per IGBT				0.065	K/W
Inverse diode						
$V_F = V_{EC}$	$I_F = 450 \text{ A}$	$T_j = 25^\circ\text{C}$		2.1	2.46	V
	$V_{GE} = 0 \text{ V}$ chip	$T_j = 150^\circ\text{C}$		2.1	2.4	V
V_{F0}		$T_j = 25^\circ\text{C}$	1.1	1.3	1.5	V
		$T_j = 150^\circ\text{C}$	0.7	0.9	1.1	V
r_F		$T_j = 25^\circ\text{C}$	1.4	1.9	2.1	m Ω
		$T_j = 150^\circ\text{C}$	2.2	2.6	2.8	m Ω
I_{RRM}	$I_F = 450 \text{ A}$	$T_j = 150^\circ\text{C}$		350		A
Q_{rr}	$di/dt_{off} = 5000 \text{ A}/\mu\text{s}$	$T_j = 150^\circ\text{C}$		70		μC
E_{rr}	$V_{GE} = -15 \text{ V}$	$T_j = 150^\circ\text{C}$		28		mJ
	$V_{CC} = 600 \text{ V}$	$T_j = 150^\circ\text{C}$				
$R_{th(j-c)}$	per diode				0.11	K/W
Freewheeling diode						
$V_F = V_{EC}$	$I_F = 450 \text{ A}$	$T_j = 25^\circ\text{C}$		2.1	2.5	V
	$V_{GE} = 0 \text{ V}$ chip	$T_j = 150^\circ\text{C}$		2.1	2.4	V
V_{F0}		$T_j = 25^\circ\text{C}$	1.1	1.3	1.5	V
		$T_j = 150^\circ\text{C}$	0.7	0.9	1.1	V
r_F		$T_j = 25^\circ\text{C}$	1.4	1.9	2.1	m Ω
		$T_j = 150^\circ\text{C}$	2.2	2.6	2.8	m Ω
I_{RRM}	$I_F = 450 \text{ A}$	$T_j = 150^\circ\text{C}$		350		A
Q_{rr}	$di/dt_{off} = 5000 \text{ A}/\mu\text{s}$	$T_j = 150^\circ\text{C}$		70		μC
E_{rr}	$V_{GE} = -15 \text{ V}$	$T_j = 150^\circ\text{C}$		28		mJ
	$V_{CC} = 600 \text{ V}$	$T_j = 150^\circ\text{C}$				
$R_{th(j-c)}$	per diode				0.11	K/W
Module						
L_{CE}				20		nH
$R_{CC'+EE'}$	res., terminal-chip	$T_C = 25^\circ\text{C}$		0.7		m Ω
		$T_C = 125^\circ\text{C}$		1		m Ω
$R_{th(c-s)}$	per module			0.04		K/W
M_s	to heat sink (M5)		3		5	Nm
M_t		to terminals (M6)	2.5		5	Nm
						Nm
w					300	g
Temperatur Sensor						
R_{100}	$T_C=100^\circ\text{C}$ ($R_{25}=5 \text{ k}\Omega$)			$493 \pm 5\%$		Ω
$B_{100/125}$	$R(T)=R_{100}\exp[B_{100/125}(1/T-1/T_{100})]$; $T[\text{K}]$;			3550 $\pm 2\%$		K

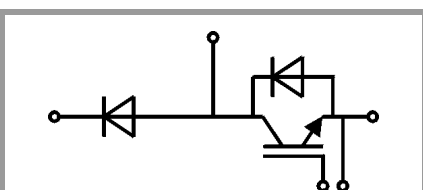

GAL

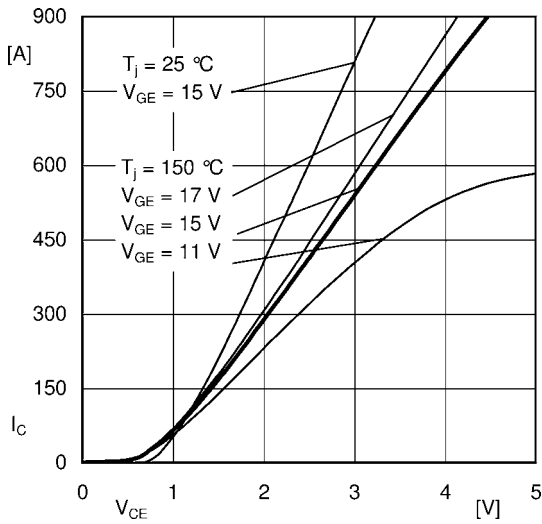

Fig. 1: Typ. output characteristic, inclusive $R_{CC'+EE'}$

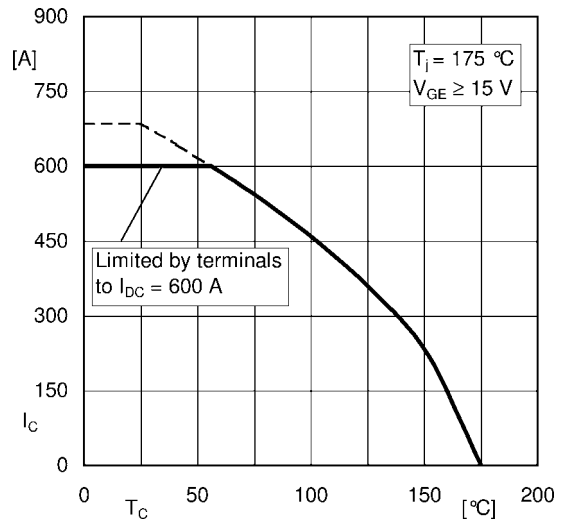

Fig. 2: Rated current vs. temperature $I_C = f(T_C)$

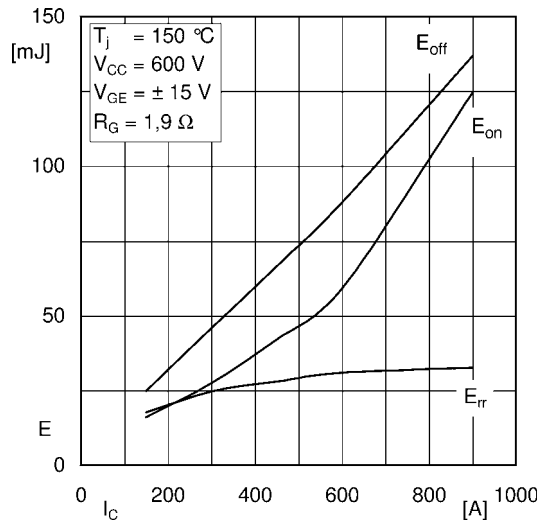

Fig. 3: Typ. turn-on /-off energy = $f(I_C)$

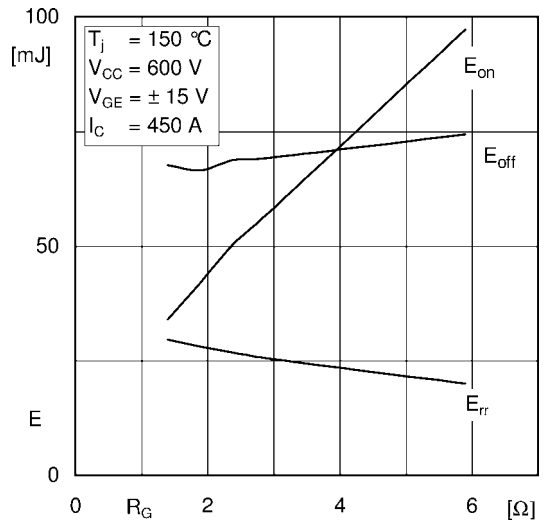

Fig. 4: Typ. turn-on /-off energy = $f(R_G)$

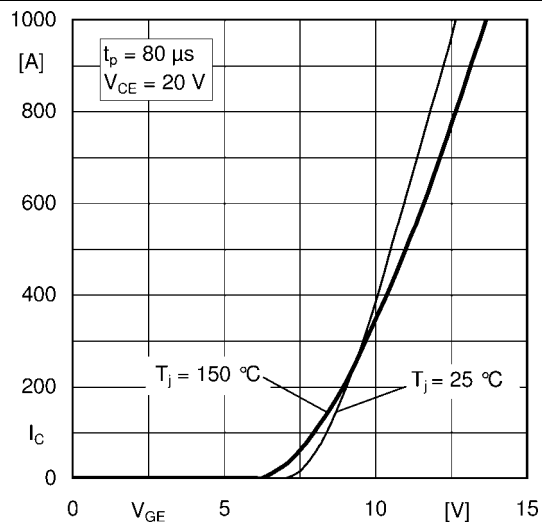

Fig. 5: Typ. transfer characteristic

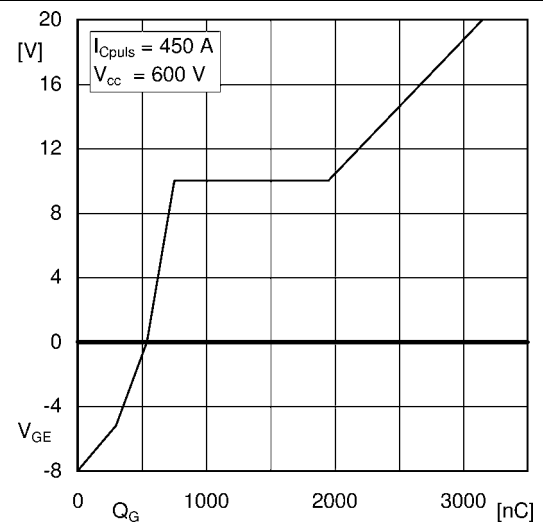

Fig. 6: Typ. gate charge characteristic

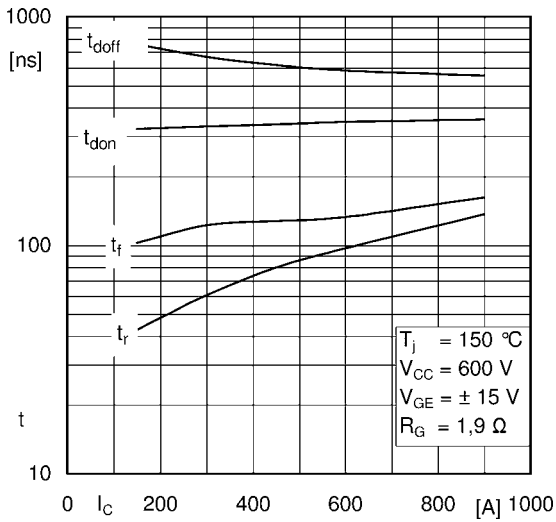

Fig. 7: Typ. switching times vs. I_C

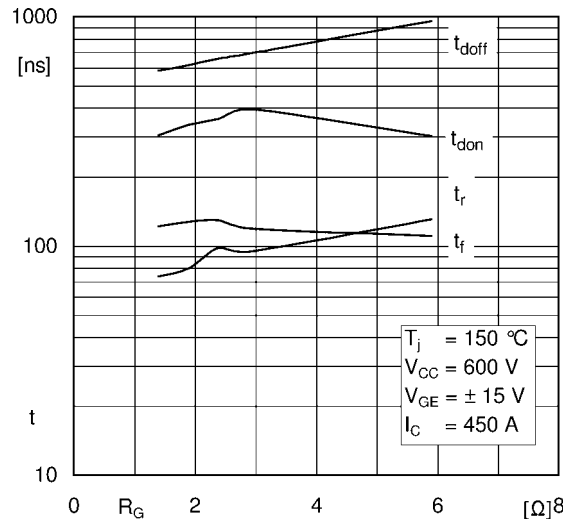

Fig. 8: Typ. switching times vs. gate resistor R_G

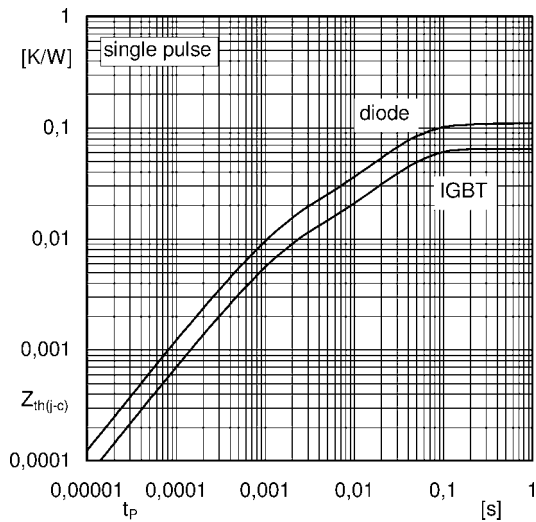

Fig. 9: Typ. transient thermal impedance

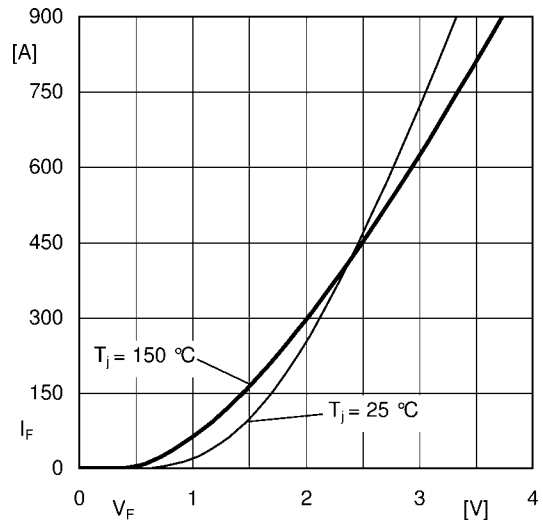

Fig. 10: Typ. CAL diode forward charact., incl. $R_{CC+EE'}$

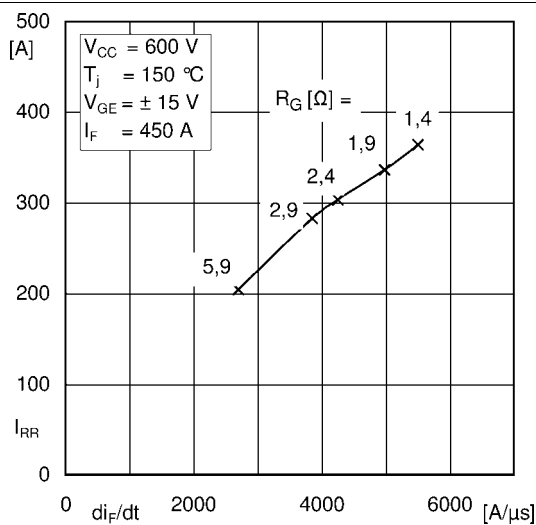

Fig. 11: Typ. CAL diode peak reverse recovery current

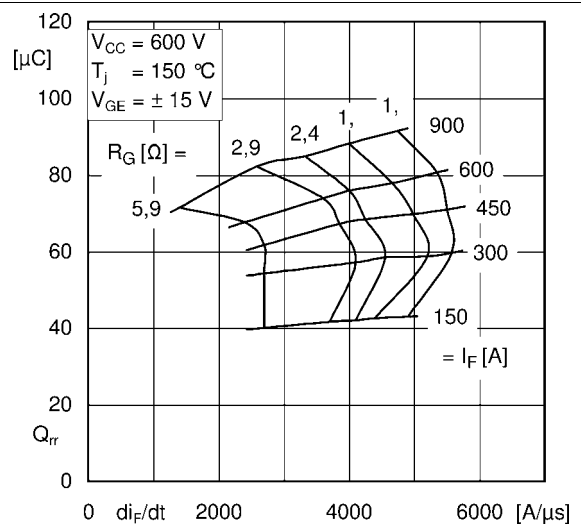
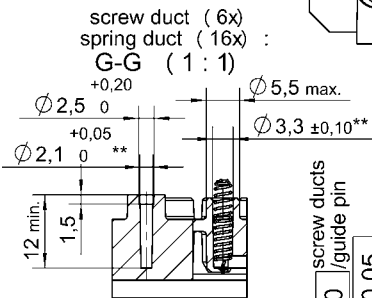
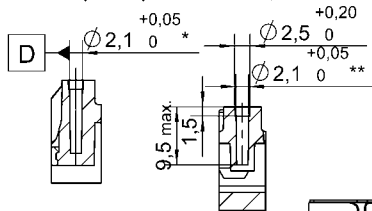

Fig. 12: Typ. CAL diode recovery charge

SEMiX453GAL12E4s

Case: SEMiX 3s

screw duct (left top) : F-F (1:1)
 screw duct (1x centre) : H-H (1:1)



\square	0,3	connector 1-2 / 3-4
\parallel	0,2	each connector A

general tolerance:
 ISO 2768-mK
 ISO 8015

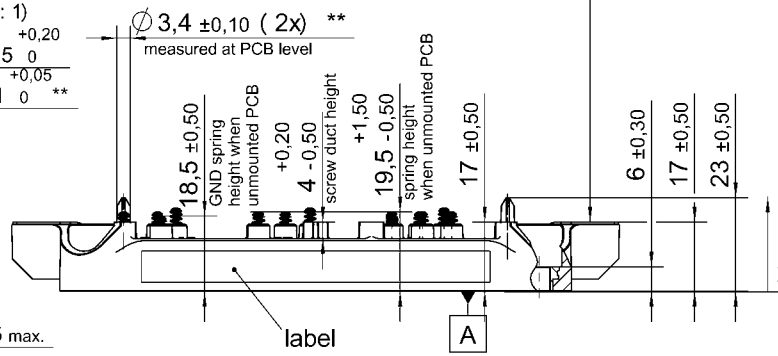

All measures in Z-direction valid when mounted to heat sink

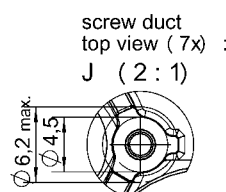
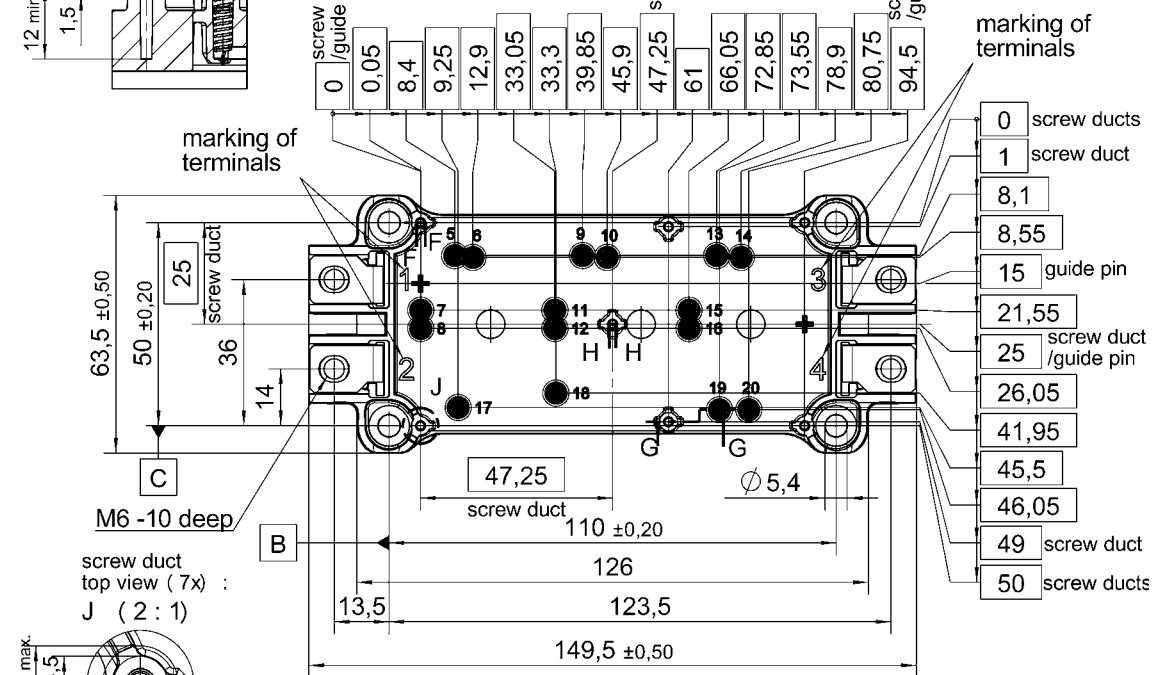

*screw duct left / top with	ϕ	0,2	A	B	C	Rules for the contact PCB: - holes guidepins = $\phi 4 \pm 0,1$ / position tolerance $\pm 0,1$ - holes for screws = $\phi 2,9 \pm 0,1$ / position tolerance $\pm 0,1$ - spring contact pad = $\phi 3,6 \pm 0,1$ / position tolerance $\pm 0,1$
**screw ducts / guide pins / spring ducts with	ϕ	0,2	A	D	C	

SEMiX 3s

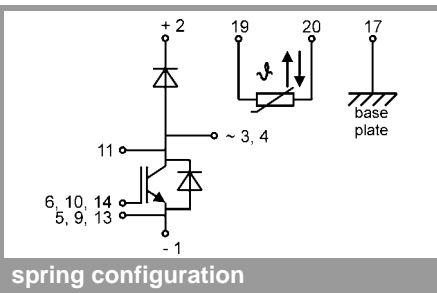

spring configuration

This is an electrostatic discharge sensitive device (ESDS), international standard IEC 60747-1, Chapter IX

* The specifications of our components may not be considered as an assurance of component characteristics. Components have to be tested for the respective application. Adjustments may be necessary. The use of SEMIKRON products in life support appliances and systems is subject to prior specification and written approval by SEMIKRON. We therefore strongly recommend prior consultation of our personal.