

Infrared Components

Ceramic Discrete Surface Mount Emitters and Detectors

SME/SMD Series

FEATURES

- Small package size
- Glass lensed optics for efficient optical coupling
- Upright or inverted mounting capability
- Low profile, small size for flexible layout of multiple channels and custom arrays
- Compatible with automated solder processes:
 - IR reflow
 - vapor phase
 - solder wave
 - convection oven
- Choice of photodiode or phototransistor detectors
- IRED features high power dissipation capability
- Tape and reel packaging option – pick and place machine compatible

APPLICATIONS

- Optical encoders for motion control
- Computer peripherals
- Vending and point-of-sale applications
- Smoke detectors
- Medical equipment

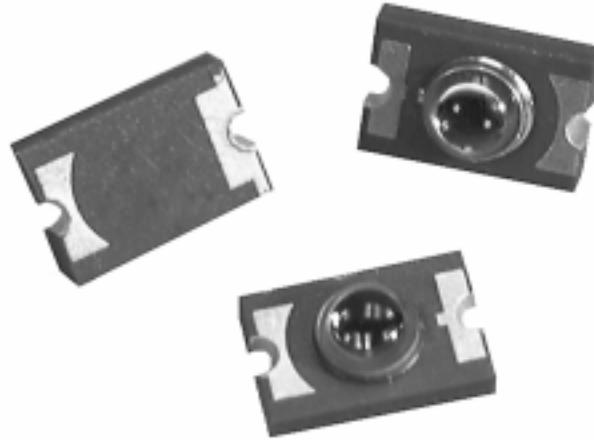

The SME2470, SMD2440 and SMD2420 Series surface mount infrared components are small ceramic packages (0.15 x 0.10 x 0.083 in. / 3,81 x 2,54 x 2,1 mm) with glass lenses. The lens minimizes cross talk and often eliminates the need for apertures in non-critical applications. The low profile components may be mounted on the printed circuit board, lens up or inverted, allowing flexibility in layouts for multiple channel and custom arrays. When mounted lens down over a hole in the PC board, the lens is hidden, lowering overall package height.

The SME2470 is a high intensity aluminum gallium arsenide infrared emitting diode (IRED) which can be used with either the SMD2440 phototransistor or the SMD2420 photodiode. It supplies optimum optical characteristics and efficient optical coupling. The small size and high power dissipation properties of the IRED promote PC board miniaturization and high density placement.

The SMD2440 Series phototransistor's gain characteristics make it useful for applications requiring high responsivity. The SMD2420 Series photodiode is especially useful in applications requiring linear response or high switching speed.

These components are available in bulk, or on tape and reel for use with automatic placement equipment.

Infrared Components

Ceramic Discrete Surface Mount

SME/SMD Series

SME2470 SERIES IRED ABSOLUTE MAXIMUM RATINGS

Power dissipation @ 25 °C*	150 mW
Continuous forward current	75 mA (mounted on a PC board)
Reverse voltage ($I_F = 10 \mu\text{A}$)	3 V
Operating free air temperature range	-55° to +125°C (-67° to +257°F)
Storage temperature	-65° to +150°C (-85° to +302°F)
Soldering temperature	260°C (500°F), 5 seconds max.

*Derate 1.43 mW/°C above 25°C ambient.

CAUTION

STRESS DAMAGE

Functional operation of the device at or above "Absolute Maximum Ratings" for extended periods of time may affect reliability.

Failure to comply with these instructions may result in product damage.

SME2470 SERIES IRED ELECTRICAL CHARACTERISTICS (at 25°C unless otherwise noted)

Parameter	Test Conditions	Sym.	Min.	Typ.	Max.	Units
Irradiance	Measured into 0.104 in. (2.64 mm) dia. aperture @ 0.535 in. (13.59 mm) from lens tip. $I_F = 50 \text{ mA}$	H	0.6			mW/cm ²
Forward voltage	$I_F = 50 \text{ mA}$	V_F		1.5	1.8	Volts
Reverse breakdown voltage	$I_R = 10 \mu\text{A}$	BV_R	3.0			Volts
Peak output wavelength	$I_F = 50 \text{ mA}$	λ		880		nm
Spectral bandwidth	$I_F = 50 \text{ mA}$			80		nm
Rise time	10 μsec pulse width	t_R		800		ns
Fall time		t_F		700		ns

TYPICAL IRED PERFORMANCE CHARACTERISTICS

SME2470 Spectral Bandwidth

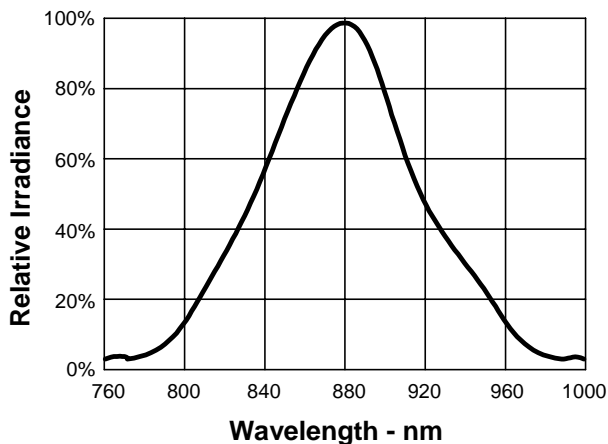

SME2470 Irradiance vs Angular Displacement

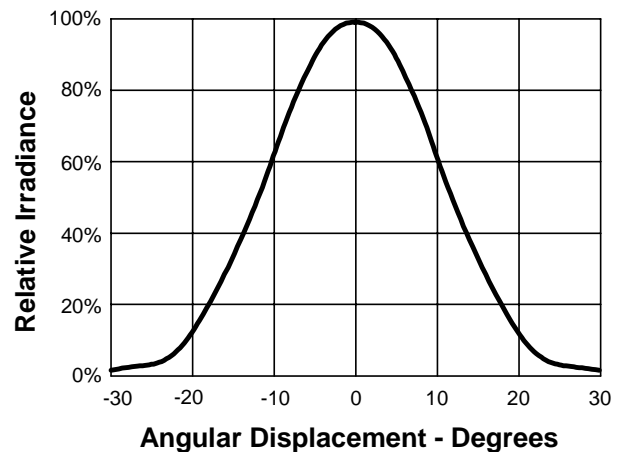

Infrared Components

Ceramic Discrete Surface Mount

SME/SMD Series

TYPICAL IRED PERFORMANCE CHARACTERISTICS (when solder mounted to PC board)

SME2470 Forward Current vs Forward Voltage

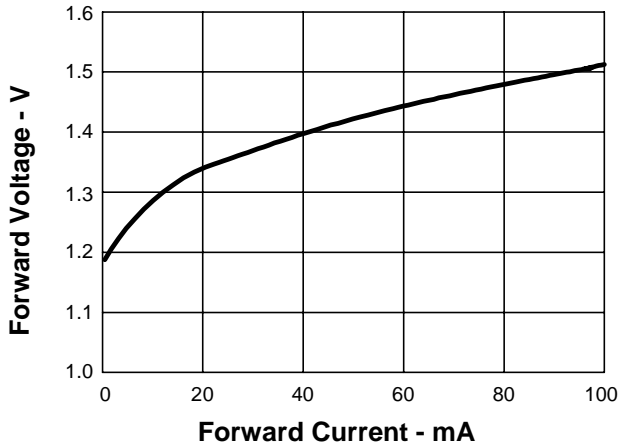

SME2470 Forward Voltage vs Temperature

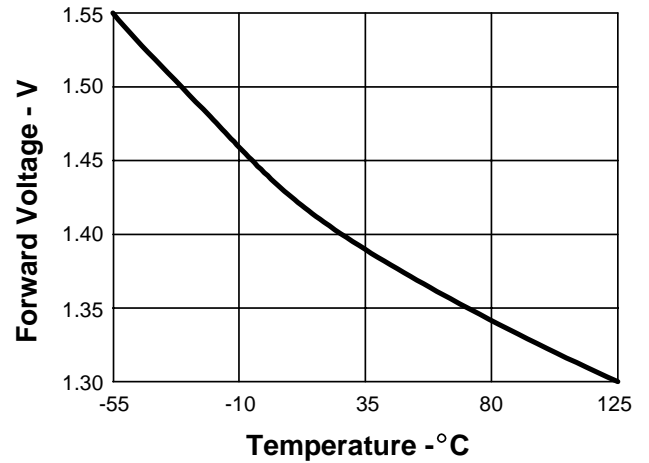

SME2470 Irradiance vs Temperature

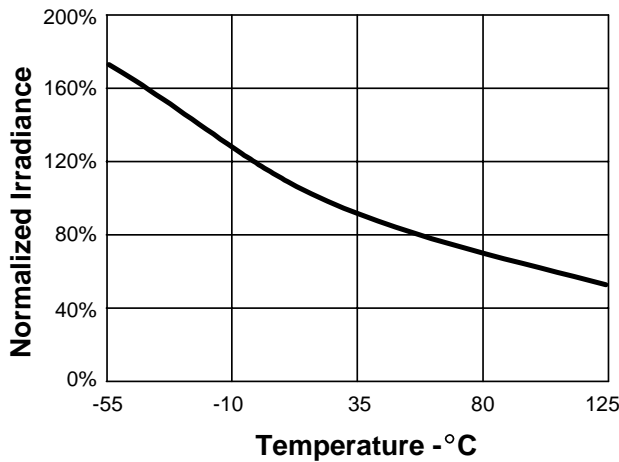

SME2470 Irradiance vs Forward Current

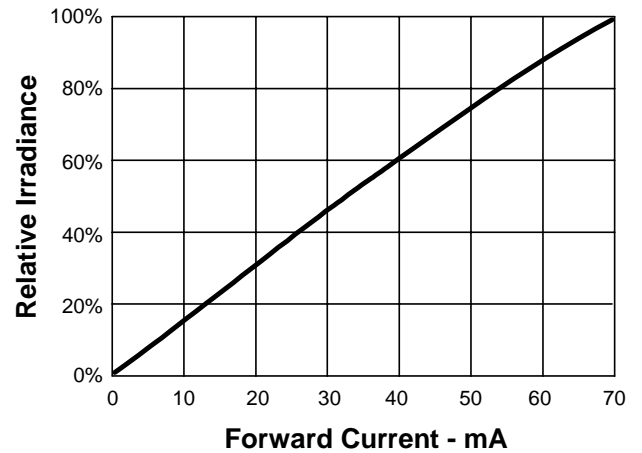

Infrared Components

Ceramic Discrete Surface Mount

SME/SMD Series

SMD2440 SERIES PHOTOTRANSISTOR ABSOLUTE MAXIMUM RATINGS

Collector-Emitter voltage	30 V
Emitter-Collector voltage	5 V
Continuous device dissipation*	125 mW
Operating free air range	-55° to +125°C (-67° to +257°F)
Storage temperature	-65° to +150°C (-85° to +302°F)
Soldering temperature	260°C (500°F), 5 seconds max.

*Derate 1.43 mW/°C above 25°C ambient.

SMD2440 SERIES PHOTOTRANSISTOR ELECTRICAL CHARACTERISTICS

Parameter	Test Conditions	Sym.	Min.	Typ.	Max.	Units	
Light current	-0X1	$V_{CE} = 5 \text{ V}, H = 1 \text{ mW/cm}^2,$ 880 nm light source	I_L	1.5		4.0	mA
	-0X2			3.0		8.0	mA
Dark current	$V_{CE} = 10 \text{ V}, H = 0$	I_D			100	nA	
Collector breakdown voltage	$I_C = 100 \mu\text{A}, H = 0$	BV_{CEO}	30			Volts	
Emitter breakdown voltage	$I_E = 100 \mu\text{A}, H = 0$	BV_{ECO}	5			Volts	
Saturation voltage (C to E)	$I_C = 0.04 \text{ mA}, H = 1 \text{ mW/cm}^2$	$V_{CE(SAT)}$		0.2	0.4	Volts	
Peak response wavelength		λ		880		nm	
Rise time	$V_{CC} = 5 \text{ V}, R_L = 1000 \Omega, I_L = 1 \text{ mA}$	t_R		15		μs	
Fall time		t_F		15		μs	

SMD2420 SERIES PHOTODIODE ABSOLUTE MAXIMUM RATINGS

Cathode-Anode voltage	50 V
Continuous device dissipation*	125 mW
Operating free air range	-55° to +125°C (-67° to +257°F)
Storage temperature	-65° to +150°C (-85° to +302°F)
Soldering temperature	260°C (500°F), 5 seconds max.

*Derate 1.43 mW/°C above 25°C ambient.

SMD2420 SERIES PHOTODIODE ELECTRICAL CHARACTERISTICS

Parameter	Test Conditions	Sym.	Min.	Typ.	Max.	Units
Light current	$V_R = 20 \text{ V}, H = 1 \text{ mW/cm}^2$ *	I_L	6			μA
Dark current	$V_R = 20 \text{ V}, h = 0$	I_D			5	nA
Reverse breakdown voltage	$I_R = 10 \mu\text{A}, H = 0$	BV_R	50			Volts
Peak response wavelength		λ		880		nm
Rise time	$V_R = 20 \text{ V}, R_L = 100 \Omega, I_L = 10 \mu\text{A}$	t_R		20		ns
Fall time		t_F		20		ns

*From 880 nm source

Infrared Components

Ceramic Discrete Surface Mount

SME/SMD Series

TYPICAL SMD2440 AND SMD2420 SERIES PERFORMANCE CHARACTERISTICS (when solder mounted to PC board)

SMD2440 and SMD2420 Spectral Responsivity

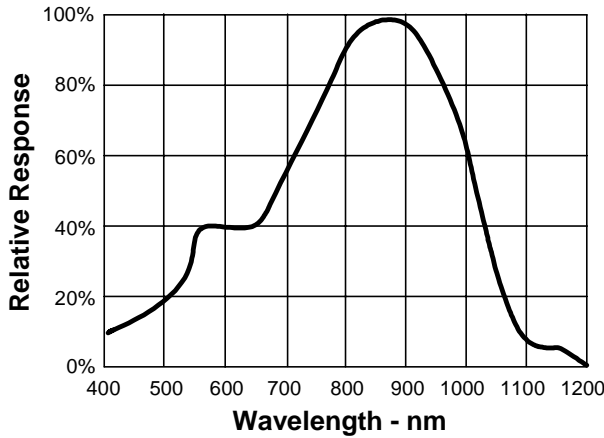

SMD2440 and SMD2420 Responsivity vs Angular Displacement

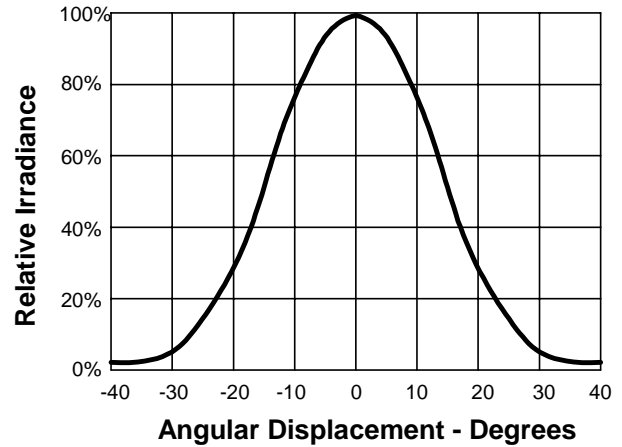

SMD2440 Dark Current vs Temperature

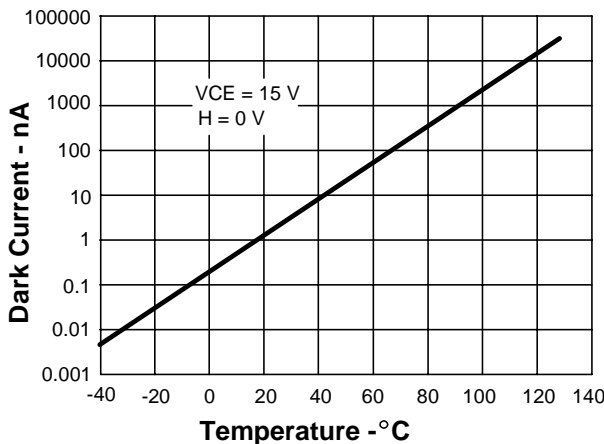

SMD2420 Dark Current vs Temperature

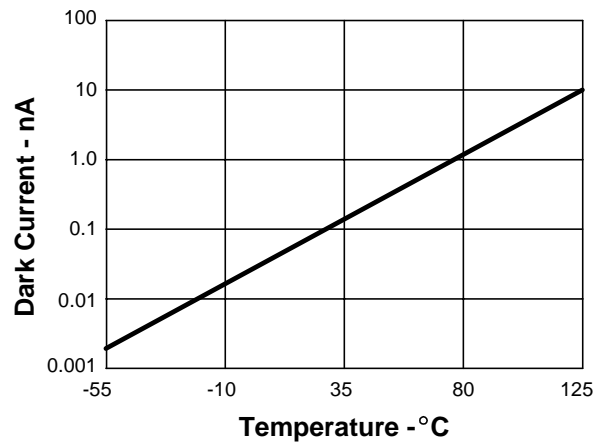

SMD2440 Collector Current vs Ambient Temperature

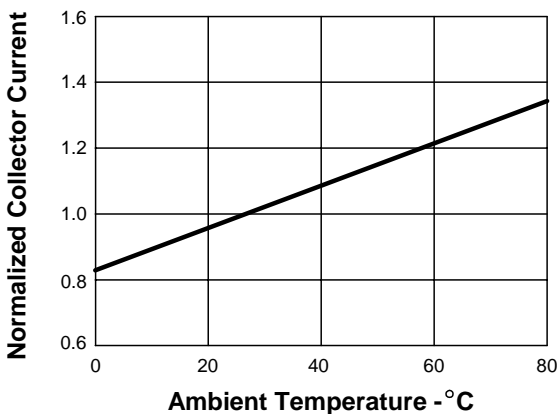

SMD2440 Non-saturated Switching Time vs Load Resistance

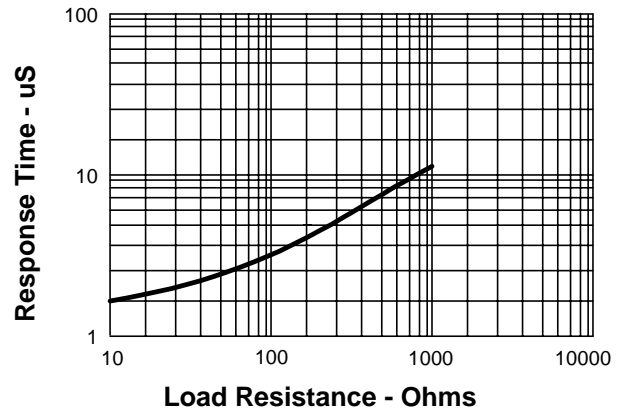

Infrared Components

Ceramic Discrete Surface Mount

SME/SMD Series

TYPICAL SMD2440 AND SMD2420 SERIES PERFORMANCE CHARACTERISTICS (when solder mounted to PC board)

SME to SMD Coupling Characteristics

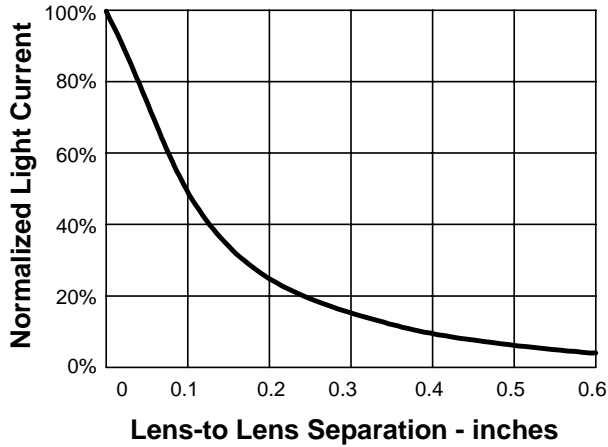

SMD2440 Switching Time Test Circuit

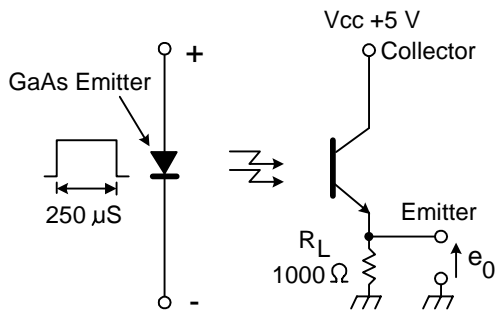

SMD2440 Switching Waveform

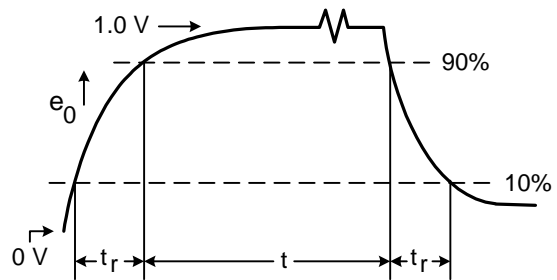

SMD2420 Switching Time Test Circuit

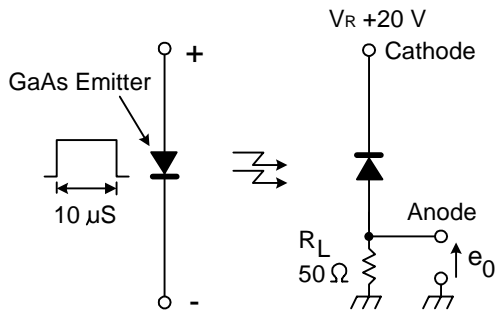

SMD2420 Switching Waveform

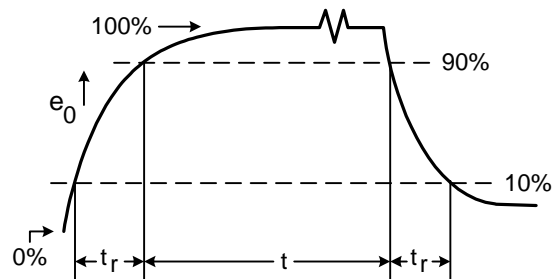

Infrared Components

Ceramic Discrete Surface Mount

SME/SMD Series

SME2470, SMD2440, SMD2420 OUTLINE DIMENSIONS in./(mm) (for reference only)

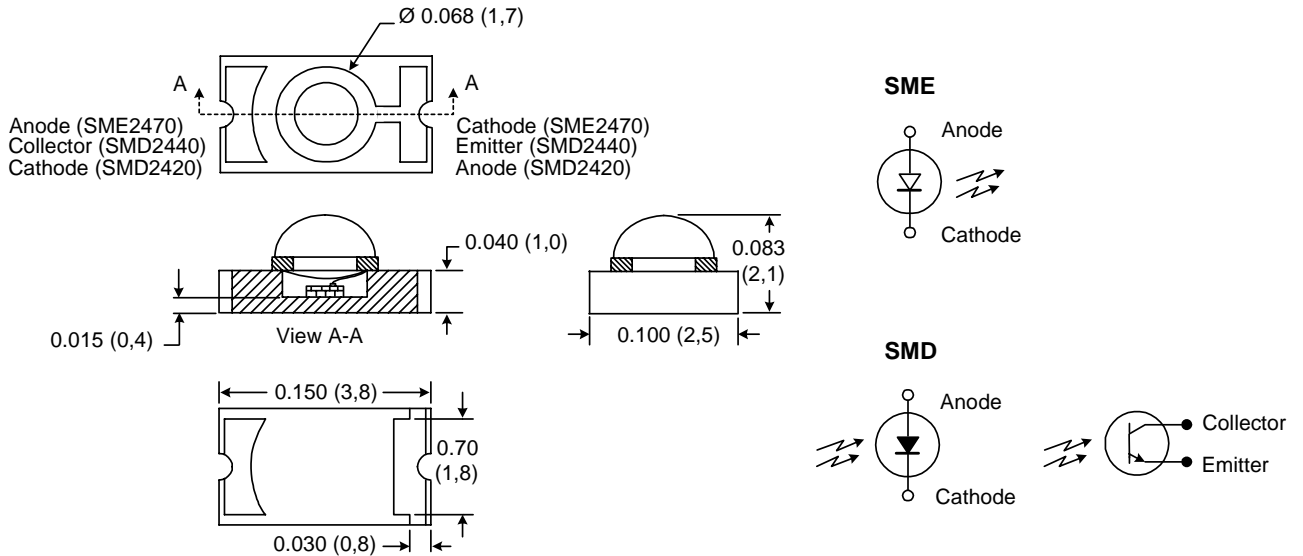

TAPE AND REEL MOUNTING CONFIGURATIONS: EIA STD 12 mm tape and reel with a 4 mm pitch in.(mm)

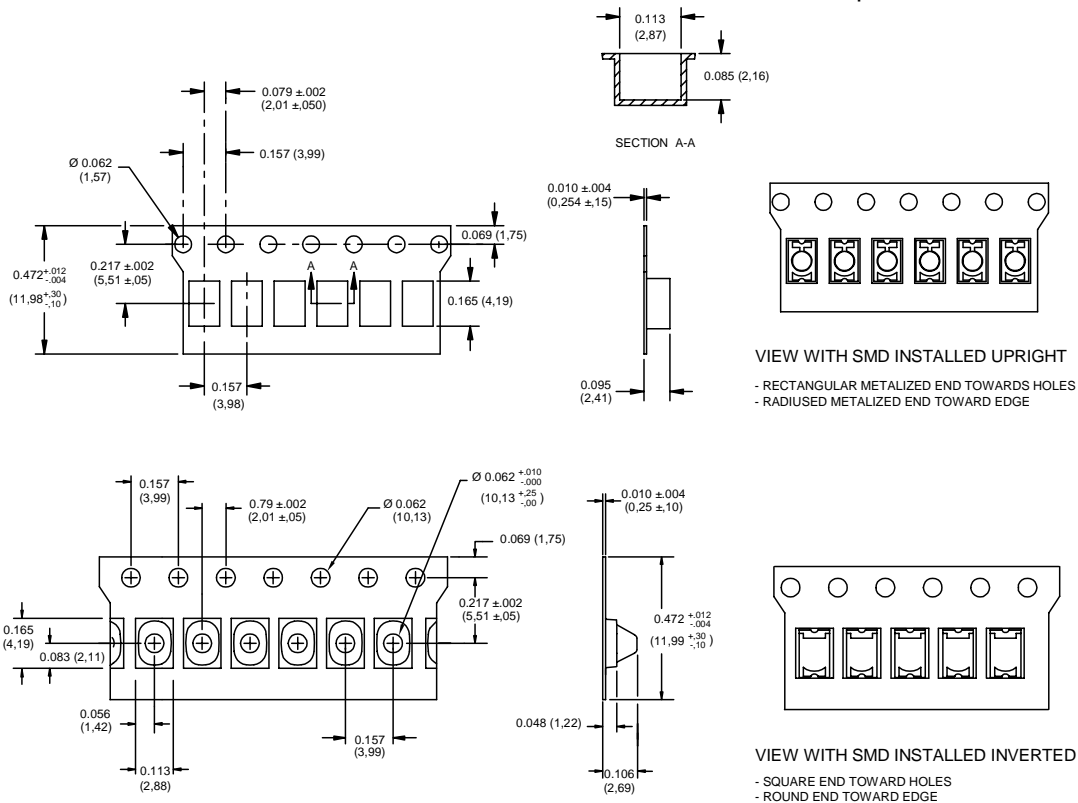

Infrared Components

Ceramic Discrete Surface Mount

SME/SMD Series

ORDER GUIDE

Catalog Listing	Description
SME2470-001	Bulk Packaged, Surface Mount IR Emitter
SMD2420-001	Bulk Packaged, Surface Mount Photodiode
SMD2440-001	Bulk Packaged, Surface Mount Phototransistor
SMD2440-002	Bulk Packaged, Surface Mount Phototransistor
SME2470-011	Tape and Reel, Inverted, Surface Mount IR Emitter
SMD2420-011	Tape and Reel, Inverted, Surface Mount Photodiode
SMD2440-011	Tape and Reel, Inverted, Surface Mount Phototransistor
SMD2440-012	Tape and Reel, Inverted, Surface Mount Phototransistor
SME2470-021	Tape and Reel Upright, Surface Mount IR Emitter
SMD2420-021	Tape and Reel, Upright, Surface Mount Photodiode
SMD2440-021	Tape and Reel, Upright, Surface Mount Phototransistor
SMD2440-022	Tape and Reel, Upright, Surface Mount Phototransistor

WARRANTY/REMEDY

Honeywell warrants goods of its manufacture as being free of defective material and faulty workmanship. Contact your local sales office for warranty information. If warranted goods are returned to Honeywell during that period of coverage, Honeywell will repair or replace without charge those items it finds defective. The foregoing is Buyer's sole remedy and is **in lieu of all other warranties, expressed or implied, including those of merchantability and fitness for a particular purpose.**

While we provide application assistance, personally, through our literature, and through the Honeywell website, it is up to the customer to determine the suitability of the product in the application.

Specifications may change at any time without notice. The information we supply is believed to be accurate and reliable as of this printing. However, we assume no responsibility for its use.

SALES AND SERVICE

Sensing and Control serves its customers through a worldwide network of sales offices and distributors. For application assistance, current specifications, pricing or name of the nearest Authorized Distributor, contact a nearby sales office or call:

TELEPHONE

1-800-537-6945 (USA)
1-800-737-3360 (Canada)
1-815-235-6847 (International)

FAX

1-815-235-6545 (USA)

INTERNET

www.honeywell.com/sensing
info@micro.honeywell.com

Honeywell

HONEYWELL
Sensing and Control
Honeywell Inc.
11 West Spring Street
Freeport, Illinois 61032

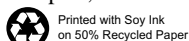

006445-2-EN IL50 GLO 199 Printed in USA

www.honeywell.com/sensing