

BIPOLAR ANALOG INTEGRATED CIRCUIT

μ PC79Lxx Series

THREE TERMINAL NEGATIVE VOLTAGE REGULATOR

Phase-out/Discontinued

<R> DESCRIPTION

The μ PC79Lxx Series are three-terminal negative output voltage stabilization power supply circuit of fixed output voltage. It regulates non-stabilized DC input voltage to output stabilized fixed voltage.

The four types of voltage value are -5 V, -8 V, -12 V, and -15 V, and they can be respectively used as power supply circuit with maximum current capacity 100 mA.

<R> FEATURES

- Output current : 100 mA
- On-chip some protection circuits
(over current protection, thermal shut down)
- Low noise : $31 \mu\text{V}$ r.m.s. (μ PC79L05)
- High ripple rejection : 85 dB (μ PC79L05)
- TO-92 package

<R> ORDERING INFORMATION

Part Number	Package	Output Voltage	Marking	Package Type
μ PC79L05J	3-PIN PLASTIC SIP (TO-92)	-5 V	79L05	Packed in envelope
μ PC79L05J-A ^{Note}	3-PIN PLASTIC SIP (TO-92)	-5 V	79L05	Packed in envelope
μ PC79L05J-T	3-PIN PLASTIC SIP (TO-92)	-5 V	79L05	Cube type taping 2500 pcs/cube
μ PC79L05J-T-A ^{Note}	3-PIN PLASTIC SIP (TO-92)	-5 V	79L05	Cube type taping 2500 pcs/cube
μ PC79L08J	3-PIN PLASTIC SIP (TO-92)	-8 V	79L08	Packed in envelope
μ PC79L08J-A ^{Note}	3-PIN PLASTIC SIP (TO-92)	-8 V	79L08	Packed in envelope
μ PC79L08J-T	3-PIN PLASTIC SIP (TO-92)	-8 V	79L08	Cube type taping 2500 pcs/cube
μ PC79L08J-T-A ^{Note}	3-PIN PLASTIC SIP (TO-92)	-8 V	79L08	Cube type taping 2500 pcs/cube
μ PC79L12J	3-PIN PLASTIC SIP (TO-92)	-12 V	79L12	Packed in envelope
μ PC79L12J-A ^{Note}	3-PIN PLASTIC SIP (TO-92)	-12 V	79L12	Packed in envelope
μ PC79L12J-T	3-PIN PLASTIC SIP (TO-92)	-12 V	79L12	Cube type taping 2500 pcs/cube
μ PC79L12J-T-A ^{Note}	3-PIN PLASTIC SIP (TO-92)	-12 V	79L12	Cube type taping 2500 pcs/cube
μ PC79L15J	3-PIN PLASTIC SIP (TO-92)	-15 V	79L15	Packed in envelope
μ PC79L15J-A ^{Note}	3-PIN PLASTIC SIP (TO-92)	-15 V	79L15	Packed in envelope
μ PC79L15J-T	3-PIN PLASTIC SIP (TO-92)	-15 V	79L15	Cube type taping 2500 pcs/cube
μ PC79L15J-T-A ^{Note}	3-PIN PLASTIC SIP (TO-92)	-15 V	79L15	Cube type taping 2500 pcs/cube

Note Pb-free (This product does not contain Pb in external electrode and other parts).

Remark Output voltage -5 V product is written in the text as μ PC79L05.
It applies to other output voltage products as same.

The information in this document is subject to change without notice. Before using this document, please confirm that this is the latest version.
Not all products and/or types are available in every country. Please check with an NEC Electronics sales representative for availability and additional information.

PIN CONFIGURATION (Marking Side)

3-PIN PLASTIC SIP (TO-92)

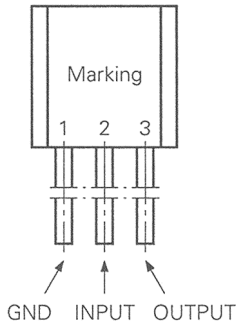

EQUIVALENT CIRCUIT

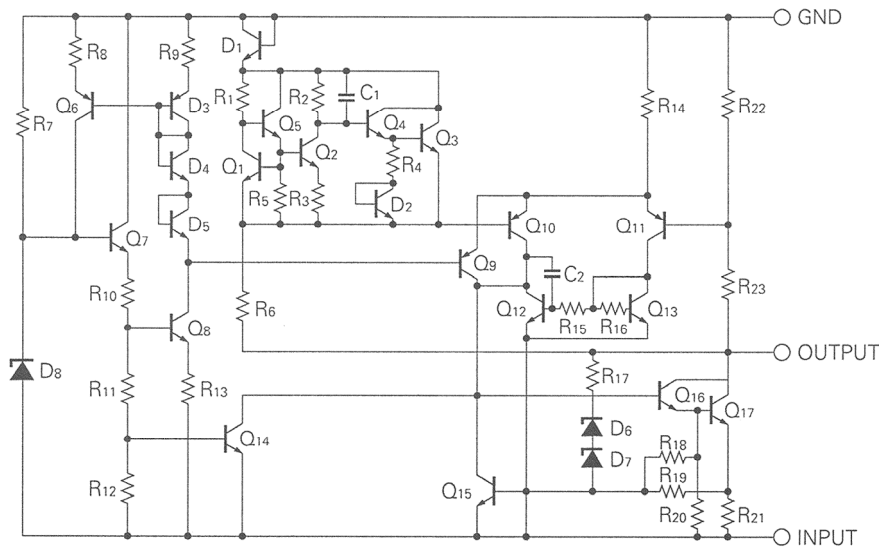

ABSOLUTE MAXIMUM RATINGS (T_A = 25°C, unless otherwise specified)

Parameter	Symbol	Rating	Unit
Input Voltage	V _{IN}	-30/-35 ^{Note}	V
Internal Power Dissipation	P _T	700	mW
Operating Ambient Temperature	T _A	-20 to +85	°C
Operating Junction Temperature	T _J	-20 to +150	°C
Storage Temperature	T _{stg}	-55 to +150	°C
Thermal Resistance (junction to ambient)	R _{th(J-A)}	180	°C/W

Note μ PC79L05, 08 : -30 V, μ PC79L12, 15 : -35 V

<R> **Caution** Product quality may suffer if the absolute maximum rating is exceeded even momentarily for any parameter. That is, the absolute maximum ratings are rated values at which the product is on the verge of suffering physical damage, and therefore the product must be used under conditions that ensure that the absolute maximum ratings are not exceeded.

<R> **TYPICAL CONNECTION**

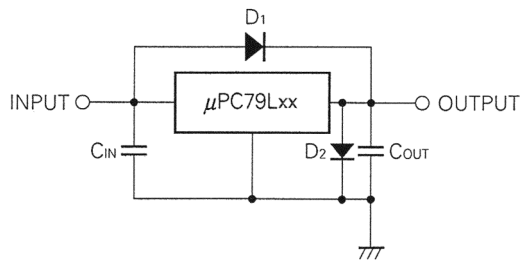

C_{IN} : Required if regulator is located an appreciable distance from power supply filter (More than 2.2 μ F).

C_{OUT}: Connect it within 2 cm from OUTPUT pin and GND pin (More than 1 μ F).

D₁ : Needed for V_{IN} > V_O.

D₂ : Needed for V_O > GND.

RECOMMENDED OPERATING CONDITIONS

Parameter	Symbol	Type Number	MIN.	TYP.	MAX.	Unit
Input Voltage	V _{IN}	μ PC79L05	-7	-10	-20	V
		μ PC79L08	-10.5	-14	-23	V
		μ PC79L12	-14.5	-19	-27	V
		μ PC79L15	-17.5	-23	-30	V
Output Current	I _o	All	0	40	70	mA
Operating Ambient Temperature	T _A	All	-20		+85	°C
Operating Junction Temperature	T _J	All	-20	75	+125	°C

ELECTRICAL CHARACTERISTICS

μPC79L05 (V_{IN} = -10 V, I_o = 40 mA, 0°C ≤ T_J ≤ +125°C, C_{IN} = 2.2 μF, C_{OUT} = 1 μF, unless otherwise specified)

Parameter	Symbol	Conditions	MIN.	TYP.	MAX.	Unit
Output Voltage	V _o	T _J = 25°C	-4.8	-5.0	-5.2	V
		-7 V ≤ V _{IN} ≤ -20 V, 1 mA ≤ I _o ≤ 40 mA	-4.75		-5.25	V
Line Regulation	REG _{IN}	T _J = 25°C, -7 V ≤ V _{IN} ≤ -20 V		3	60	mV
Load Regulation	REG _L	T _J = 25°C, 1 mA ≤ I _o ≤ 100 mA		10	50	mV
Quiescent Current	I _{BIAS}	T _J = 25°C		4.2	6.0	mA
Quiescent Current Change	ΔI _{BIAS}	-7 V ≤ V _{IN} ≤ -20 V, I _o = 40 mA			0.5	mA
		V _{IN} = -10 V, 1 mA ≤ I _o ≤ 40 mA			0.1	mA
Output Noise Voltage	V _n	T _J = 25°C, 10 Hz ≤ f ≤ 100 kHz		31	200	μV _{r.m.s.}
Ripple Rejection	R•R	T _J = 25°C, -8 V ≤ V _{IN} ≤ -18 V, f = 120 Hz	65	85		dB
Dropout Voltage	V _{DIF}	T _J = 25°C		0.9		V
Short Circuit Current	I _{short}	T _J = 25°C, V _{IN} = -20 V		95		mA
Peak Output Current	I _{Opeak}	T _J = 25°C	140	190	230	mA
Temperature Coefficient of Output Voltage	ΔV _o /ΔT	I _o = 5 mA		0.4		mV/°C

μPC79L08 (V_{IN} = -14 V, I_o = 40 mA, 0°C ≤ T_J ≤ +125°C, C_{IN} = 2.2 μF, C_{OUT} = 1 μF, unless otherwise specified)

Parameter	Symbol	Conditions	MIN.	TYP.	MAX.	Unit
Output Voltage	V _o	T _J = 25°C	-7.7	-8.0	-8.3	V
		-10.5 V ≤ V _{IN} ≤ -23 V, 1 mA ≤ I _o ≤ 40 mA	-7.6		-8.4	V
Line Regulation	REG _{IN}	T _J = 25°C, -10.5 V ≤ V _{IN} ≤ -23 V		5	60	mV
Load Regulation	REG _L	T _J = 25°C, 1 mA ≤ I _o ≤ 100 mA		12	80	mV
Quiescent Current	I _{BIAS}	T _J = 25°C		4.3	6.0	mA
Quiescent Current Change	ΔI _{BIAS}	-10.5 V ≤ V _{IN} ≤ -23 V, I _o = 40 mA			0.5	mA
		V _{IN} = -14 V, 1 mA ≤ I _o ≤ 40 mA			0.1	mA
Output Noise Voltage	V _n	T _J = 25°C, 10 Hz ≤ f ≤ 100 kHz		56	220	μV _{r.m.s.}
Ripple Rejection	R•R	T _J = 25°C, -12 V ≤ V _{IN} ≤ -22 V, f = 120 Hz	63	75		dB
Dropout Voltage	V _{DIF}	T _J = 25°C		0.9		V
Short Circuit Current	I _{short}	T _J = 25°C, V _{IN} = -23 V		75		mA
Peak Output Current	I _{Opeak}	T _J = 25°C	140	190	230	mA
Temperature Coefficient of Output Voltage	ΔV _o /ΔT	I _o = 5 mA		0.6		mV/°C

μPC79L12 (V_{IN} = -19 V, I_o = 40 mA, 0°C ≤ T_J ≤ +125°C, C_{IN} = 2.2 μF, C_{OUT} = 1 μF, unless otherwise specified)

Parameter	Symbol	Conditions	MIN.	TYP.	MAX.	Unit
Output Voltage	V _o	T _J = 25°C	-11.5	-12.0	-12.5	V
		-14.5 V ≤ V _{IN} ≤ -27 V, 1 mA ≤ I _o ≤ 40 mA	-11.4		-12.6	V
Line Regulation	REG _{IN}	T _J = 25°C, -14.5 V ≤ V _{IN} ≤ -27 V		8	45	mV
Load Regulation	REG _L	T _J = 25°C, 1 mA ≤ I _o ≤ 100 mA		15	100	mV
Quiescent Current	I _{BIAS}	T _J = 25°C		4.4	6.0	mA
Quiescent Current Change	ΔI _{BIAS}	-14.5 V ≤ V _{IN} ≤ -30 V, I _o = 40 mA			0.5	mA
		V _{IN} = -19 V, 1 mA ≤ I _o ≤ 40 mA			0.1	mA
Output Noise Voltage	V _n	T _J = 25°C, 10 Hz ≤ f ≤ 100 kHz		88	280	μV _{r.m.s.}
Ripple Rejection	R•R	T _J = 25°C, -15 V ≤ V _{IN} ≤ -25 V, f = 120 Hz	55	70		dB
Dropout Voltage	V _{DIF}	T _J = 25°C		0.9		V
Short Circuit Current	I _{Oshort}	T _J = 25°C, V _{IN} = -27 V		50		mA
Peak Output Current	I _{Opeak}	T _J = 25°C	140	190	230	mA
Temperature Coefficient of Output Voltage	ΔV _o /ΔT	I _o = 5 mA		0.8		mV/°C

μPC79L15 (V_{IN} = -23 V, I_o = 40 mA, 0°C ≤ T_J ≤ +125°C, C_{IN} = 2.2 μF, C_{OUT} = 1 μF, unless otherwise specified)

Parameter	Symbol	Conditions	MIN.	TYP.	MAX.	Unit
Output Voltage	V _o	T _J = 25°C	-14.4	-15.0	-15.6	V
		-17.5 V ≤ V _{IN} ≤ -30 V, 1 mA ≤ I _o ≤ 40 mA	-14.25		-15.75	V
Line Regulation	REG _{IN}	T _J = 25°C, -17.5 V ≤ V _{IN} ≤ -30 V		10	45	mV
Load Regulation	REG _L	T _J = 25°C, 1 mA ≤ I _o ≤ 100 mA		20	125	mV
Quiescent Current	I _{BIAS}	T _J = 25°C		4.5	6.0	mA
Quiescent Current Change	ΔI _{BIAS}	-17.5 V ≤ V _{IN} ≤ -30 V, I _o = 40 mA			0.5	mA
		V _{IN} = -23 V, 1 mA ≤ I _o ≤ 40 mA			0.1	mA
Output Noise Voltage	V _n	T _J = 25°C, 10 Hz ≤ f ≤ 100 kHz		100	360	μV _{r.m.s.}
Ripple Rejection	R•R	T _J = 25°C, -18.5 V ≤ V _{IN} ≤ -28.5 V, f = 120 Hz	55	65		dB
Dropout Voltage	V _{DIF}	T _J = 25°C		0.9		V
Short Circuit Current	I _{Oshort}	T _J = 25°C, V _{IN} = -30 V		25		mA
Peak Output Current	I _{Opeak}	T _J = 25°C	140	190	230	mA
Temperature Coefficient of Output Voltage	ΔV _o /ΔT	I _o = 5 mA		1.0		mV/°C

TYPICAL CHARACTERISTICS (T_J = 25°C, unless otherwise specified)

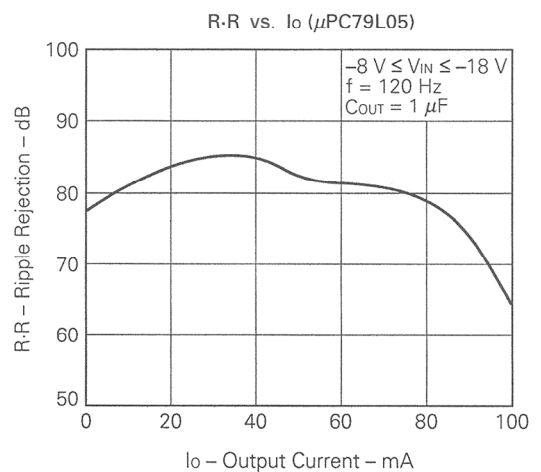
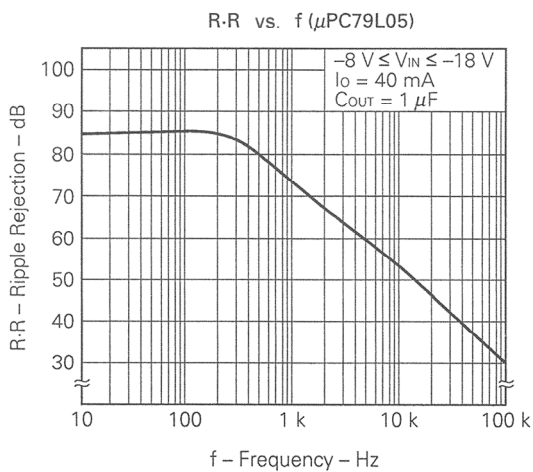
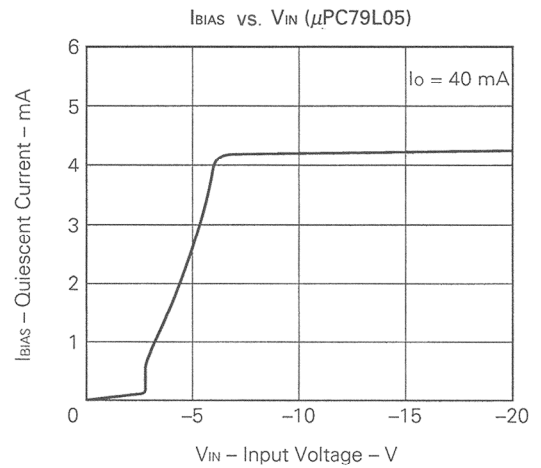
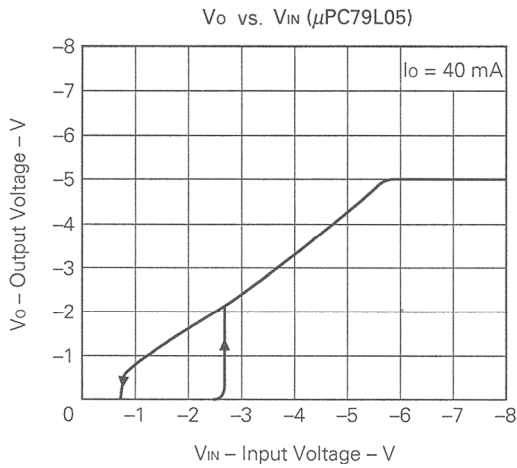
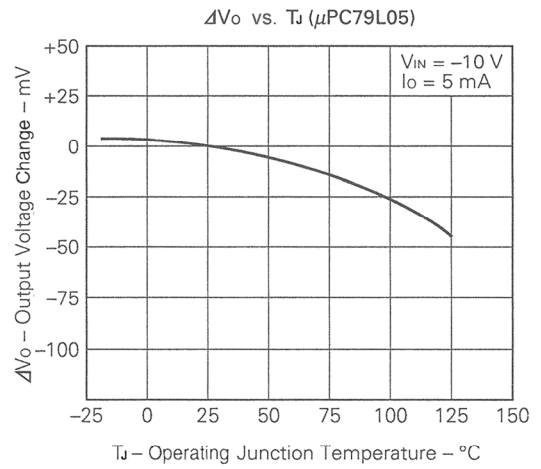
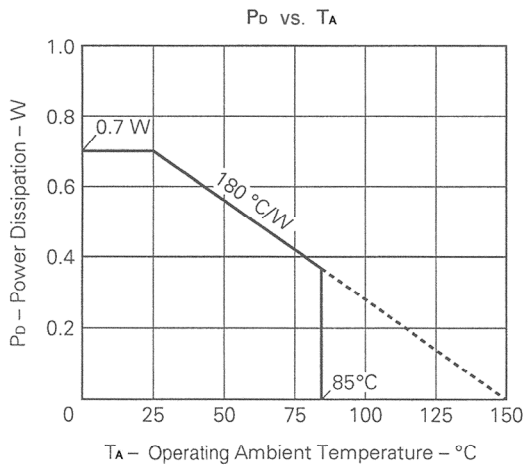

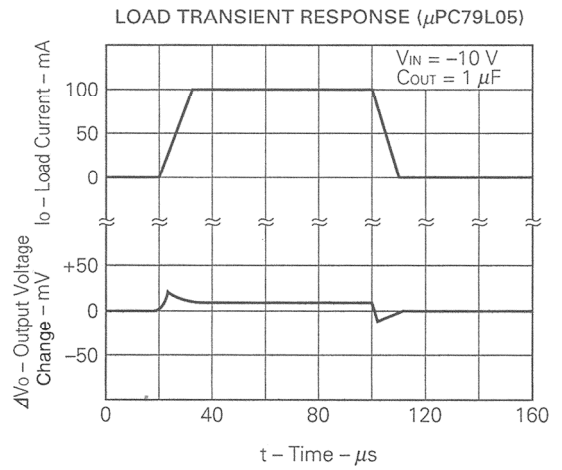
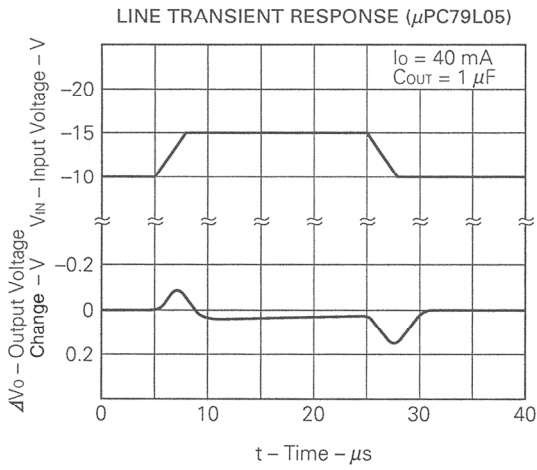
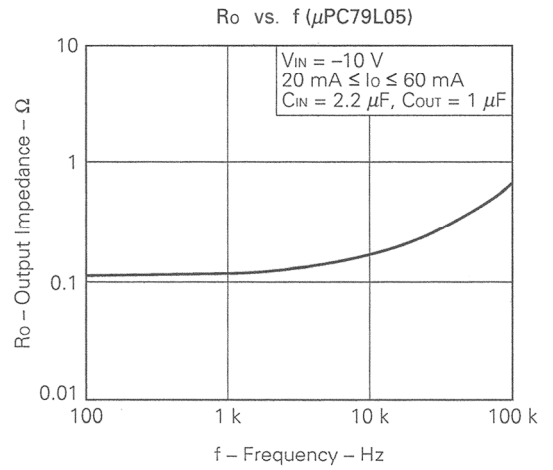
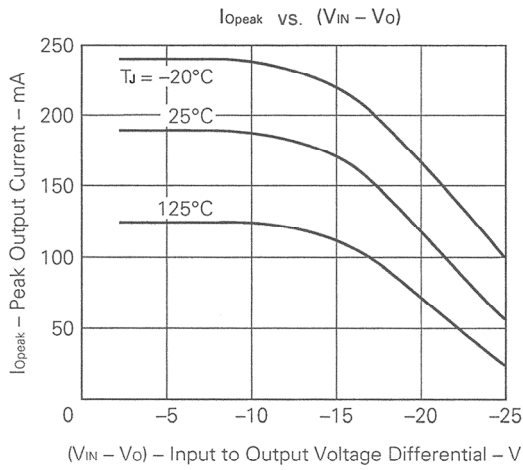

<R> PACKAGE DRAWING (Unit: mm)

3-PIN PLASTIC SIP (TO-92)

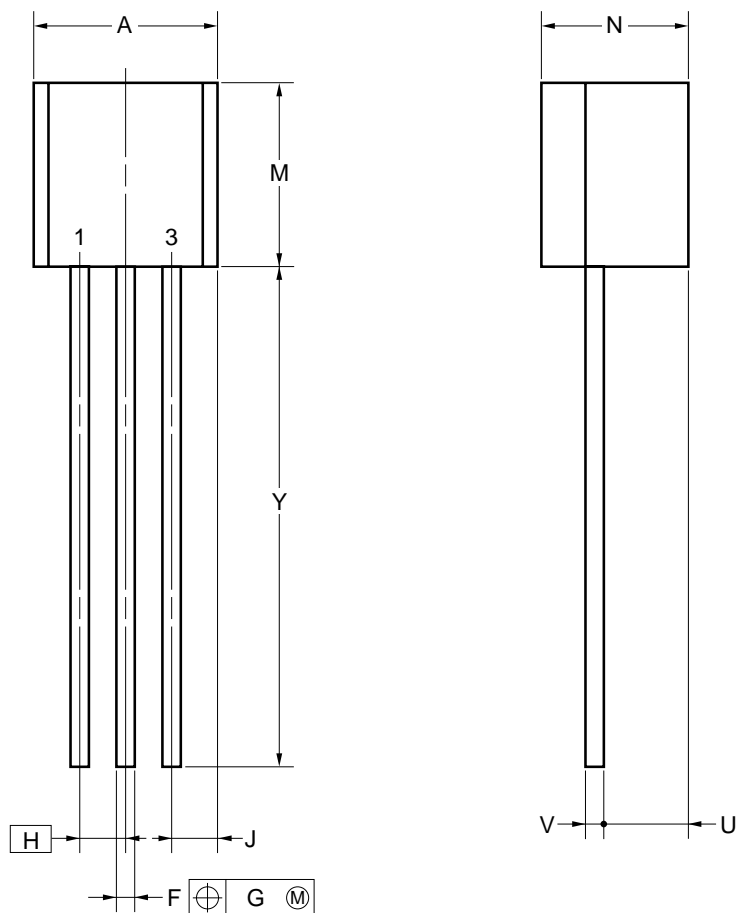

NOTE

Each lead centerline is located within 0.12 mm of its true position (T.P.) at maximum material condition.

ITEM	MILLIMETERS
A	5.0±0.2
F	0.50 ^{+0.30} _{-0.10}
G	0.12
H	1.27
J	1.33 MAX.
M	5.0±0.5
N	4.0±0.2
U	2.8 MAX.
V	0.50±0.10
Y	15.0±0.7

P3J-127B-3

<R> **RECOMMENDED SOLDERING CONDITIONS**

The μPC79Lxx Series should be soldered and mounted under the following recommended conditions.

For soldering methods and conditions other than those recommended below, contact an NEC Electronics sales representative.

For technical information, see the following website.

Semiconductor Device Mount Manual (<http://www.necel.com/pkg/en/mount/index.html>)

Through-hole devices

μPC79L05J, 79L08J, 79L12J, 79L15J,

μPC79L05J-A, 79L08J-A, 79L12J-A, 79L15J-A : 3-PIN PLASTIC SIP (TO-92)

Process	Conditions	Symbol
Wave soldering (only to leads)	Solder temperature: 260°C or below, Flow time: 10 seconds or less, Maximum number of flow processes: 1 time.	WS60-00-1
Partial heating method	Pin temperature: 350°C or below, Heat time: 3 seconds or less (Per each pin).	P350

Caution For through-hole device, the wave soldering process must be applied only to leads, and make sure that the package body does not get jet soldered.

<R> **REFERENCE DOCUMENTS**

Document Name	Document No.
Usage of Three-Terminal Regulators User's Manual	G12702E
Semiconductor Device Mount Manual	http://www.necel.com/pkg/en/mount/index.html
Review of Quality and Reliability Handbook Information	C12769E

- **The information in this document is current as of January, 2007. The information is subject to change without notice. For actual design-in, refer to the latest publications of NEC Electronics data sheets or data books, etc., for the most up-to-date specifications of NEC Electronics products. Not all products and/or types are available in every country. Please check with an NEC Electronics sales representative for availability and additional information.**

- No part of this document may be copied or reproduced in any form or by any means without the prior written consent of NEC Electronics. NEC Electronics assumes no responsibility for any errors that may appear in this document.
- NEC Electronics does not assume any liability for infringement of patents, copyrights or other intellectual property rights of third parties by or arising from the use of NEC Electronics products listed in this document or any other liability arising from the use of such products. No license, express, implied or otherwise, is granted under any patents, copyrights or other intellectual property rights of NEC Electronics or others.
- Descriptions of circuits, software and other related information in this document are provided for illustrative purposes in semiconductor product operation and application examples. The incorporation of these circuits, software and information in the design of a customer's equipment shall be done under the full responsibility of the customer. NEC Electronics assumes no responsibility for any losses incurred by customers or third parties arising from the use of these circuits, software and information.
- While NEC Electronics endeavors to enhance the quality, reliability and safety of NEC Electronics products, customers agree and acknowledge that the possibility of defects thereof cannot be eliminated entirely. To minimize risks of damage to property or injury (including death) to persons arising from defects in NEC Electronics products, customers must incorporate sufficient safety measures in their design, such as redundancy, fire-containment and anti-failure features.
- NEC Electronics products are classified into the following three quality grades: "Standard", "Special" and "Specific".

The "Specific" quality grade applies only to NEC Electronics products developed based on a customer-designated "quality assurance program" for a specific application. The recommended applications of an NEC Electronics product depend on its quality grade, as indicated below. Customers must check the quality grade of each NEC Electronics product before using it in a particular application.

"Standard": Computers, office equipment, communications equipment, test and measurement equipment, audio and visual equipment, home electronic appliances, machine tools, personal electronic equipment and industrial robots.

"Special": Transportation equipment (automobiles, trains, ships, etc.), traffic control systems, anti-disaster systems, anti-crime systems, safety equipment and medical equipment (not specifically designed for life support).

"Specific": Aircraft, aerospace equipment, submersible repeaters, nuclear reactor control systems, life support systems and medical equipment for life support, etc.

The quality grade of NEC Electronics products is "Standard" unless otherwise expressly specified in NEC Electronics data sheets or data books, etc. If customers wish to use NEC Electronics products in applications not intended by NEC Electronics, they must contact an NEC Electronics sales representative in advance to determine NEC Electronics' willingness to support a given application.

(Note)

(1) "NEC Electronics" as used in this statement means NEC Electronics Corporation and also includes its majority-owned subsidiaries.

(2) "NEC Electronics products" means any product developed or manufactured by or for NEC Electronics (as defined above).