

Xinger®

Ultra Low Profile 0805 Balun 75Ω to 75Ω Balanced

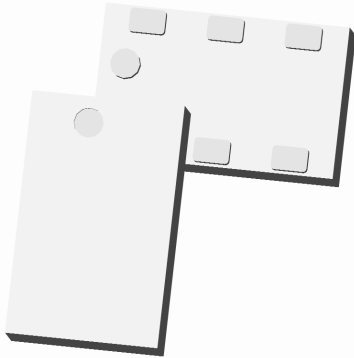

Description

The B0922J7575A50 is a low cost, low profile sub-miniature unbalanced to balanced transformer designed for differential inputs and output locations on modern chipsets in an easy to use surface mount package covering dual polarized commercial Satellite bands 950 MHz – 1450 MHz & 1650 MHz – 2150 MHz. The B0922J7575A50 is ideal for high volume manufacturing and delivers higher performance than traditional wire wound baluns. The B0922J7575A50 has an unbalanced port impedance of 75Ω and a 75Ω balanced port impedance*. This transformation enables single ended signals to be applied to differential ports on modern integrated chipsets. The output ports have equal amplitude (-3dB) with 180 degree phase differential. The B0922J7575A50 is available on tape and reel for pick and place high volume manufacturing.

Detailed Electrical Specifications: Specifications subject to change without notice.

Features:	Parameter	ROOM (25°C)			Unit
		Min.	Typ.	Max	
<ul style="list-style-type: none"> • 950 – 2150 MHz • 0.7mm Height Profile • 75 Ohm to 2 x 37.5 Ohm • Low Insertion Loss • Sat LNB Chipset Compliant • Input to Output DC Isolation • Surface Mountable • Tape & Reel • Non-conductive Surface • RoHS Compliant 	Frequency	950		2150	MHz
	Unbalanced Port Impedance		75		Ω
	Balanced Port Impedance		75		Ω
	Return Loss	12	15		dB
	Insertion Loss*		0.8	1.1	dB
	Amplitude Balance		1.0	1.4	dB
	Phase Balance		3	9	Degrees
	CMRR		25		dB
	Power Handling			2	Watts
	Operating Temperature		-55		+85

* Insertion Loss stated at room temperature (Insertion Loss is approximately 0.1 dB higher at +85 °C)

Outline Drawing

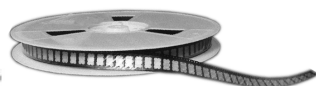
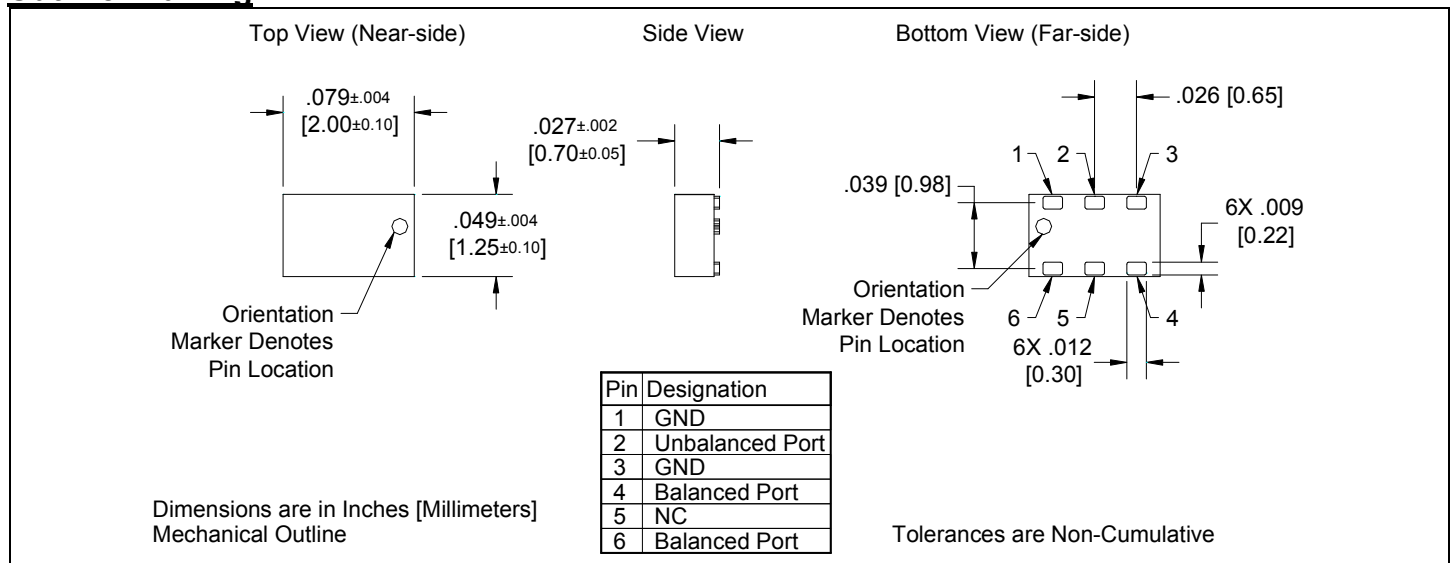

Typical Performance: 600 MHz. to 2600 MHz.

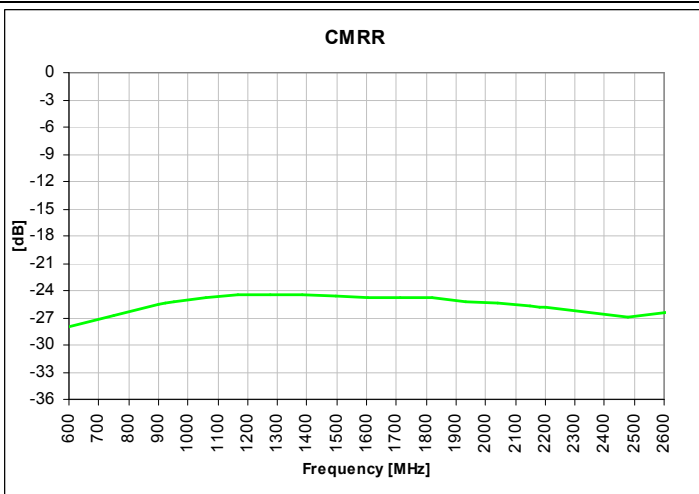
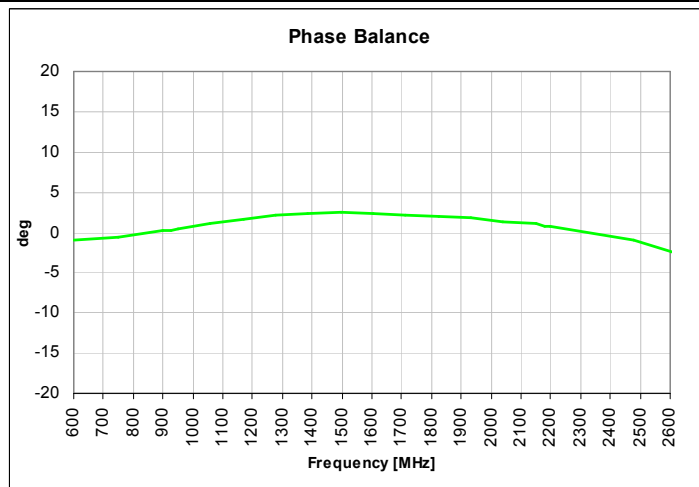
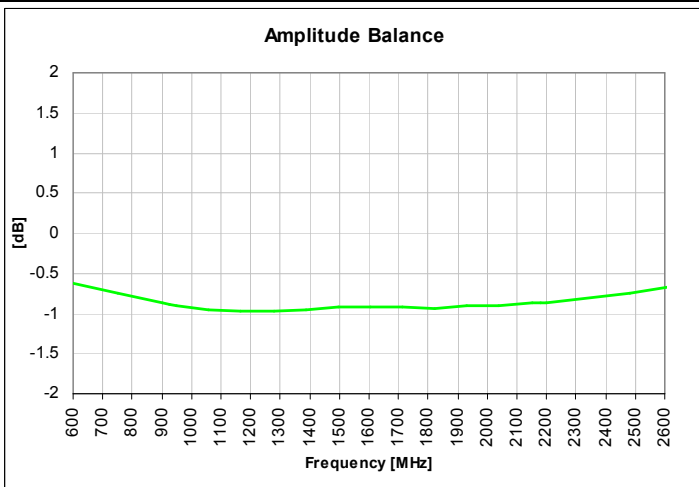
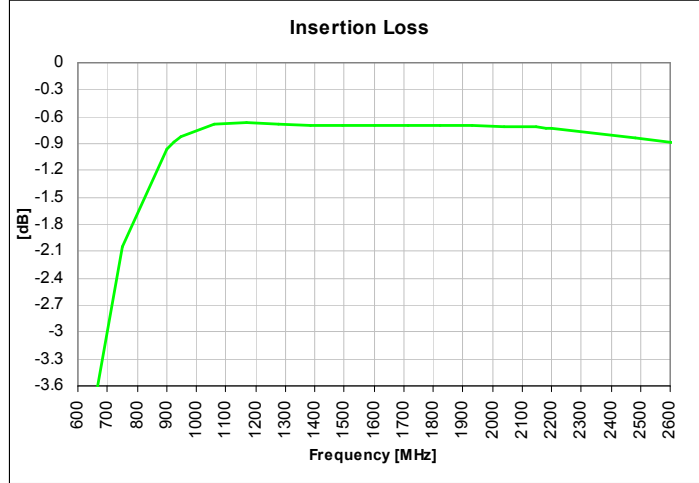
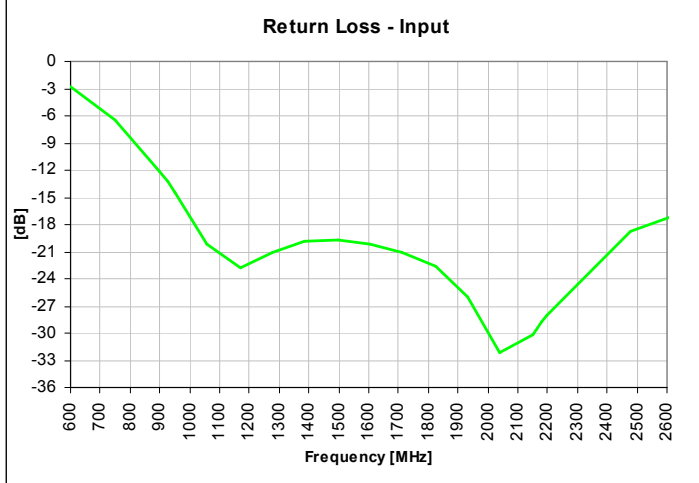

USA/Canada: (315) 432-8909
 Toll Free: (800) 411-6596
 Europe: +44 2392-232392

Available on Tape and Reel for Pick and Place Manufacturing.

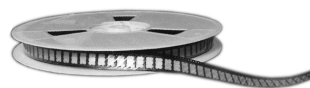

Anaren

What'll we think of next?™

Wide Band Performance: 500 MHz. to 8000 MHz.

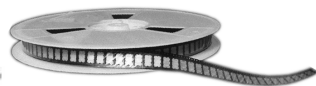
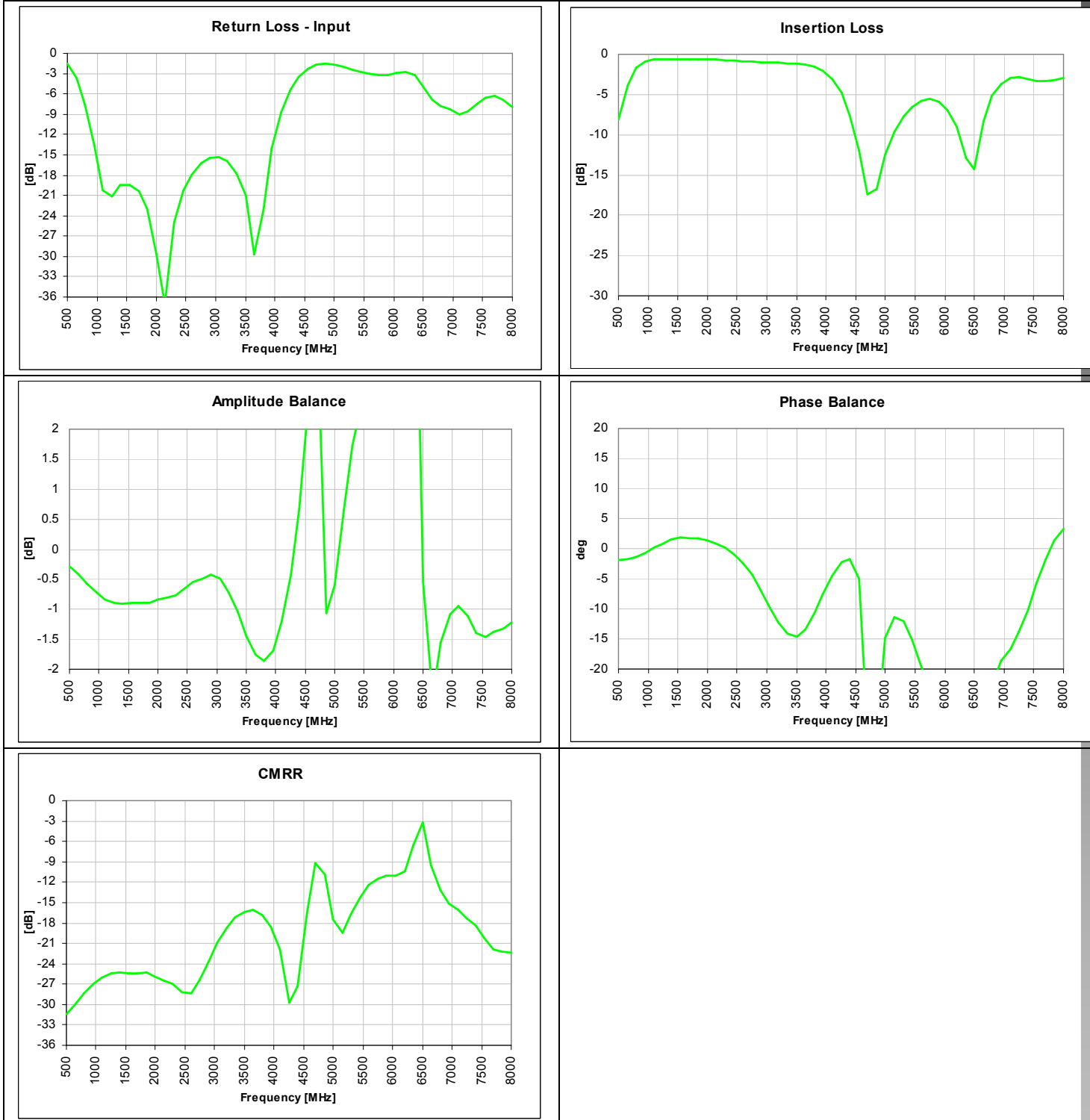

Mounting Configuration:

In order for Xinger surface mount components to work optimally, the proper impedance transmission lines must be used to connect to the RF ports. If this condition is not satisfied, insertion loss, Isolation and VSWR may not meet published specifications.

All of the Xinger components are constructed from ceramic filled PTFE composites which possess excellent electrical and mechanical stability having X and Y thermal coefficient of expansion (CTE) of 17 ppm/°C.

An example of the PCB footprint used in the testing of these parts is shown below. In specific designs, the transmission line widths need to be adjusted to the unique dielectric coefficients and thicknesses as well as varying pick and place equipment tolerances.

Mounting Footprint

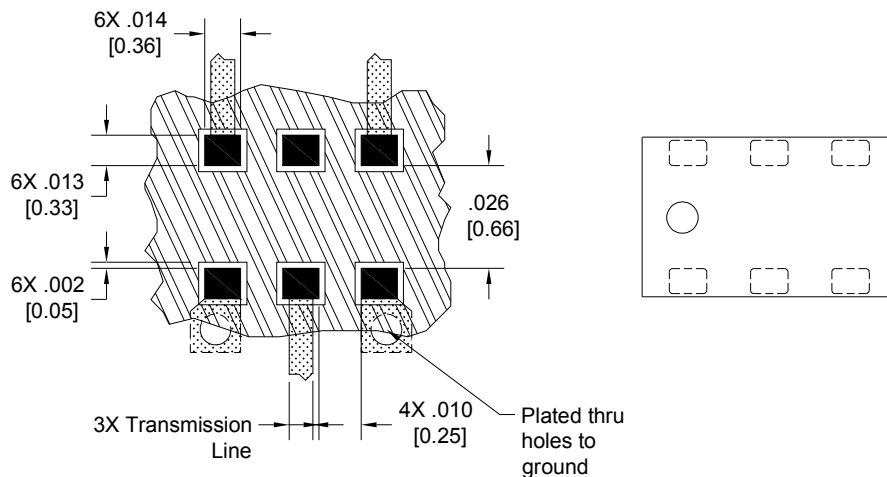

Dimensions are in Inches [Millimeters]
Mounting Footprint

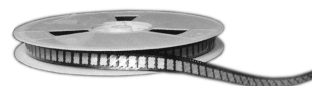

Packaging and Ordering Information

Parts are available in reel and are packaged per EIA 481-2. Parts are oriented in tape and reel as shown below. Minimum order quantities are 4000 per reel. See Model Numbers below for further ordering information.

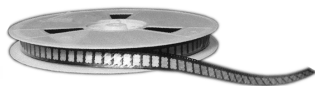
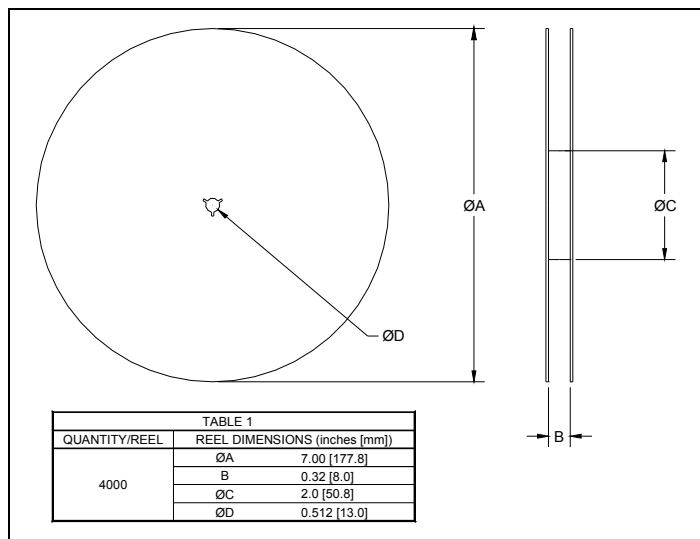
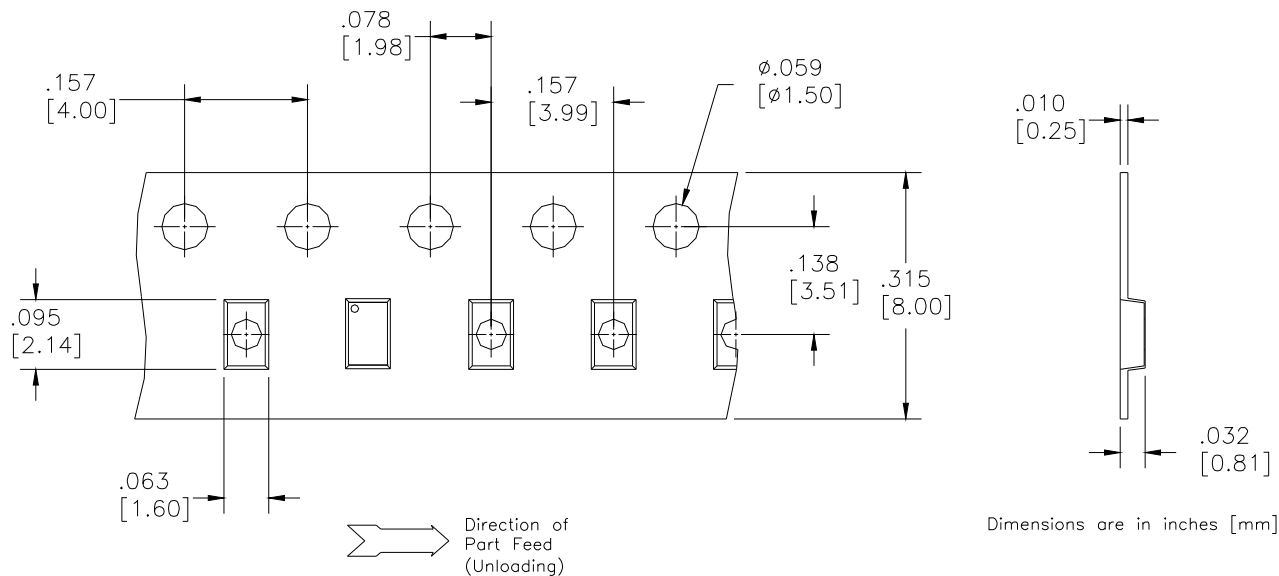

Model B0922J7575A50

Rev D

Anaren[®]

USA/Canada: (315) 432-8909
Toll Free: (800) 411-6596
Europe: +44 2392-232392

Available on Tape and
Reel for Pick and Place
Manufacturing.

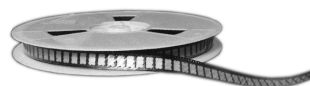

Anaren

What'll we think of next?™