

Decoupled Filter Connectors

These connectors incorporate an SMT capacitor placed between the body of the connector and the panel to which the connector is mounted. This configuration creates a three terminal device which decouples the braid of the system and all frequencies carried on it \geq the cutoff frequency (F_{co}) directly to the panel.

A potential difference exists between the body and the panel. When a shunt load is placed there, a conductive path is established and current will flow. If a device which exhibits lower resistance with increasing frequency is the shunt load, only the higher frequencies are conducted out of the system.

The capacitor in the system is actually a frequency dependent resistor, and the resistance it presents to low frequencies is termed capacitive reactance, or X_c , which is expressed in ohms. In a 50 ohm system, if a 3rd terminal is added, it will not conduct unless its resistive value is < 50 ohms (path of least resistance). As stated, capacitive reactance is a variable with respect to frequency. X_c can be approximated using the standard formula:

where F is the frequency in Hz and C is the capacitance in farads.

For example:

$$F = 1 \text{ MHz} \quad C = 1 \text{ pF} \quad X_c = \frac{1}{6.28(1 \times 10^6)(1 \times 10^{-12})} = 159.2 \text{ k}\Omega$$

In a 50 Ω system, a 1 pF capacitor would conduct a percentage of a 1 MHz signal. However, if:

$$F = 1 \text{ MHz} \quad C = 4700 \text{ pF} \quad X_c = \frac{1}{6.28(1 \times 10^6)(4.7 \times 10^{-9})} = 33.8 \text{ k}\Omega$$

In a 50 Ω system, a 4700 pF capacitor would conduct a percentage of a 1 MHz signal.

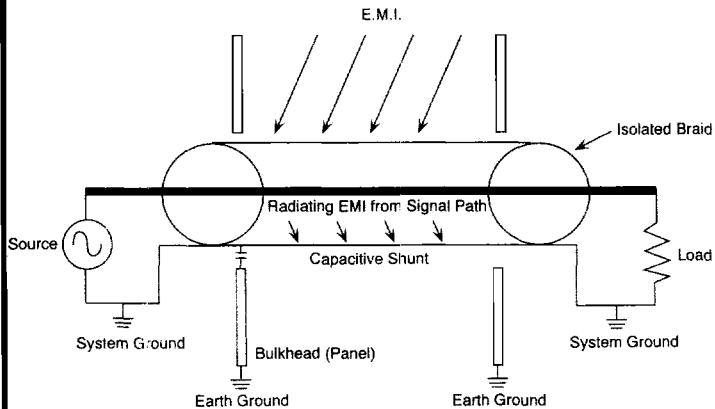

Capacitive Shunt Load Diagram

- FCC regulations Part 15, Section J, specify the reduction of radiated EMI.
- Capacitive element shunts high frequency harmonics to the panel, along with EMI induced in the braid by outside forces.

What this illustrates is a way to approximate a value of capacitance that will conduct a given range of frequencies. Parasitics of both capacitance

and inductance exhibited by the connector configuration create real-world problems that make the actual evaluation a more involved process.

The low impedance of this configuration at the higher frequencies normally associated with EMI makes this connector an ideal decoupling element. Typically, up to 30db of attenuation is realized above F_{co} . Remember, a 10db loss will attenuate 70% of the transmitted voltage and 90% of available power. 20db will attenuate 90% of the voltage.

Microprocessor and logic chips in various types of digital equipment generate signals contributing to the problem of EMI or electromagnetic interference. Certain EMI is the product of the fast rise times of digital pulses which comprise data transmission signals. These clock harmonics reach into the RF spectrum (30 - 300MHz specifically) and create noise problems if permitted to propagate in the environment. This form of EMI is transmitted in an antenna-like manner by interconnecting cables, and picked up by others. Other sources of EMI such as fluorescent light fixtures, motors, and switching power supplies also contribute to the problem of broadband EMI.

In coaxial cable networks, the braid, which is the return circuit of the system, behaves as an antenna and is susceptible to EMI. This EMI emanates from any of the listed sources including crosstalk which becomes a problem when transmission cables are grouped in clusters. The noise then becomes routed into the system and may cause problems such as false triggering, potentially leading to such problems as erroneous instrument readings. Ntt filter connectors suppress RF noise at the termination point of the cable run, preventing it from interfering with device function.

Ntt filter connections are a simple cost-effective method of suppressing broadband EMI. The connectors possess good isolation featuring compartmentalized components with no inductive leads. Useful in LAN systems, test equipment, communications, or any application where EMI must be eliminated.

For Digital Applications

Fast logic requires high band width to pass pulsed data.

$$BW = 0.35 N/TR$$

N = The highest harmonic of the propagation frequency

TR = The device's rise time

For an ideal system, calculate for the 1st to 10th harmonic. For example, a device $W/TR = 8S$ would require a BW of 43.7 MHz to 437 MHz.

Commercial AC	Sonar	AM, Marine Radio	CB, Ham Radio	FM Radio, VHF TV	Microwave Ovens, UHF TV	Microwave Commun., Radar
Very Low Freq.	Low Freq.	Medium Freq.	High Freq.	Very High Freq.	Ultra High Freq.	Super High Freq.
VLF	LF	MF	HF	VHF	UHF	SHF
0 KHz	30KHz 300 KHz	300 KHz 3 MHz	3 MHz 30 MHz	30 MHz 300 MHz	300 MHz 3 GHz	3 GHz

Filtered Panel Mount/PCB Mount

Mechanical

Dimensions: to MIL-C-39012
 Mating Cycles: 500 Min.
 Mating Force: 3 lbs. Max.
 Mating Torque (BNC only): 1.0 in. lbs. Min.
 2.5 in. lbs. Max.
 Cable Retention: 20 to 100 lbs.

Material

Body: Die Cast Zinc with Nickel Plating or Screw
 Machined Brass with Nickel Plating
 Contacts: 70/30 Brass Alloy with Silver or Gold Plating
 Insulators: Polyethylene/Valox or Teflon

ELECTRICAL

Impedance: 50 ohms Nom.*
 Working Voltage: 200 VDC
 Contact Resistance: 2.0 milliohms Max.
 Insulation Resistance: 5K megohms
 Capacitance: 4-10 nF
 Dielectric Withstanding Voltage: 500 VDC
 VSWR: 1.3 Max.
 VRMS: 60% of Rated Voltage DC
 Temp. Coefficient: $\pm 15\%$, -55° to 125° C
 Dissipation Factor: <2% @ 1 KHZ, 25° C
 Aging: 2.5% per decade hou

*Contact Ntt for 75 ohm Connectors

Environmental

Temperature Range: -55° C to +85° C
 Temperature Cycle: Method to 102-C
 Humidity: Method to 102-C
 Salt Spray: Method to 101-1

Right Angle PCB Mount

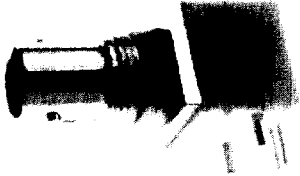

BNC 70F12 1.2 nF
 BNC 70F22 10 nF

Vertical PCB Mount



BNC 72F12 1.2NF
 BNC 72F22 10NF

Low Profile Right Angle PCB Mount



BNC 74F12 1.2nF
 BNC 74F22 10nF

Panel Mount Adapter

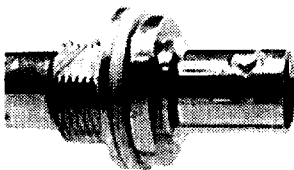

BNC 8259F 9.4nF

Panel Mount



BNC 6919F 4.7nF

Vertical Mount

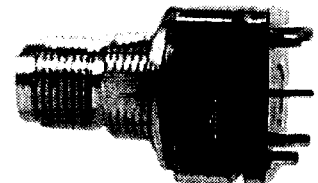

TNC 6819F 9.4nF

Crimp Type PCB Mount for RG316



TNC 1233615-02 5.6nF

Ferrite Filtered Vertical PCB Mount

*Cost Effective
 Method
 for RFI/EMI
 Noise Reduction.*



BNC 5819

General Specs for BNC & TNC Connectors

Mechanical

Dimensions: to MIL-C-39012
 Mating Cycles: 500 Min.
 Mating Force: 3 lbs. Max.
 Mating Torque (BNC only): 1.0 in. lbs Min.
 2.5 in. lbs Max.
 Cable Retention: 20 to 100 lbs.

Electrical

Impedance: 50 Ohms Nom.*
 Working Voltage: 500 RMS
 Contact Resistance: 2.0 Milliohms Max.
 Insulation Resistance: 5K Megohms
 Dielectric Strength: 1500 VRMS
 VSWR: 1.3 Max.
 Frequency Range: BNC Connectors 0-4 GHZ
 TNC Connectors 0-11 GHZ

*Contact NTT for availability of 75 ohm Connectors

Material

Body: Die Cast Zinc with Nickel Plating or Screw
 Machined Brass with Nickel Plating
 Contacts: 70/30 Brass Alloy with Silver or Gold Plating
 Insulators: Polyethylene/Valox or Teflon
 Crimp Ferrules: Copper with Nickel Plating

Environmental

Temperature Range: -55°C to +85°C
 Temperature Cycle: Method 102-C
 Humidity: Method 106
 Salt Spray: Method 101-1
 Vibration: Method 204-B
 Shock: Method 213-1

PCB Mount BNC Receptacles

PCB mount receptacles utilize a die cast zinc shell with bright nickel plating, polyethylene insulators, and either silver or gold plated contacts. The molded valox body features troughs that isolate the signal and ground leads and greatly reduce fluctuations in impedance. They are offered in right angle or vertical versions with either solder posts or screws for mounting, and with hardware packages for either panel grounding or insulating applications.

STYLE	FIG.	SILVER PLATED CONTACT	GOLD PLATED CONTACT
Right angled with mounting posts	FIG. 1	BNC 7054	BNC 7059
Right angled with mounting screws	FIG. 1	BNC 7154	BNC 7159
Vertical with mounting posts	FIG. 2	BNC 7254	BNC 7259
Vertical with mounting screws	FIG. 2	BNC 7354	BNC 7359

Figure 1

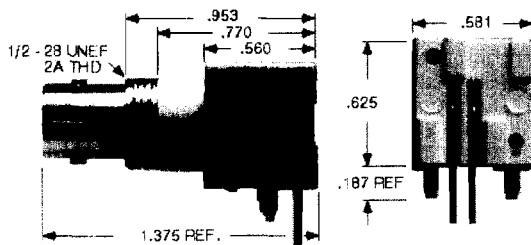
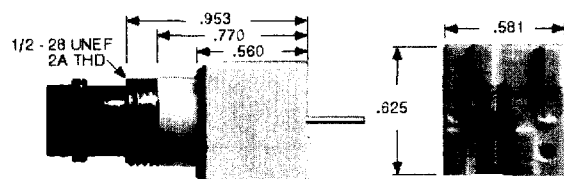
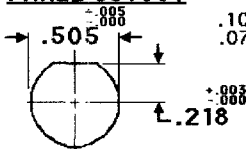

Figure 2



PANEL CUTOUT



PCB HOLE PATTERN

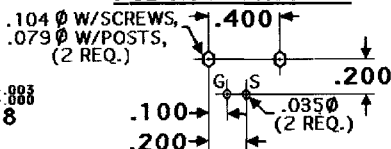

PANEL CUTOUT

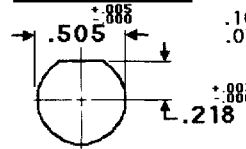

PCB HOLE PATTERN

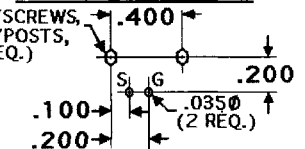

Isolated PCB Mount BNC Receptacles

RIGHT ANGLE MOUNT

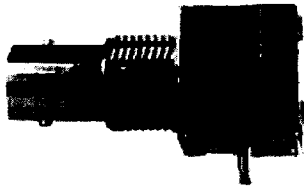

METAL BODY "H" DIMENSION - .325		
STYLE	TIN PLATED CONTACT	GOLD PLATED CONTACT
Right Angle w/ Mounting Posts	BNC 7050 D.C.	BNC 7059 D.C.
Right Angle w/ Mounting Screws	BNC 7150 D.C.	BNC 7159 D.C.

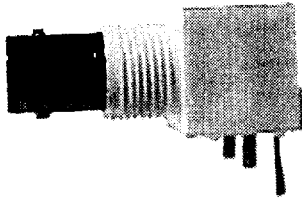

BLACK OR WHITE VALOX BODY "H" DIMENSION - .325		
STYLE	TIN PLATED CONTACT	GOLD PLATED CONTACT
Right Angle w/ Mounting Posts	BNC 9050 WHT	BNC 9059 WHT
Right Angle w/ Mounting Screws	BNC 9150 WHT	BNC 9159 WHT
Right Angle w/ Mounting Posts	BNC 9050 BLK	BNC 9059 BLK
Right Angle w/ Mounting Screws	BNC 9150 BLK	BNC 9159 BLK

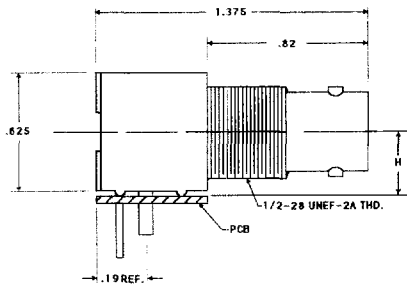

PANEL CUTOUT

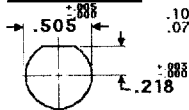

PCB HOLE PATTERN

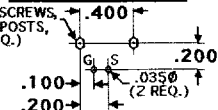

VERTICAL MOUNT

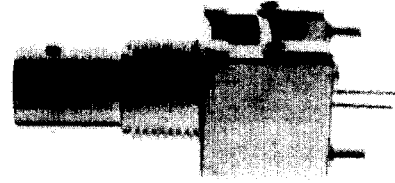

METAL BODY		
STYLE	TIN PLATED CONTACT	GOLD PLATED CONTACT
Vertical w/ Mounting Posts	BNC 7250 D.C.	BNC 7259 D.C.
Vertical w/ Mounting Screws	BNC 7350 D.C.	BNC 7359 D.C.

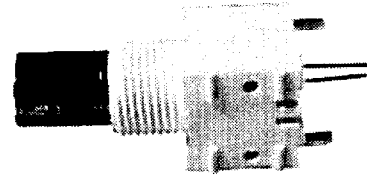

BLACK OR WHITE VALOX BODY		
STYLE	TIN PLATED CONTACT	GOLD PLATED CONTACT
Vertical w/ Mounting Posts	BNC 9250 WHT	BNC 9259 WHT
Vertical w/ Mounting Screws	BNC 9350 WHT	BNC 9359 WHT
Vertical w/ Mounting Posts	BNC 9250 BLK	BNC 9259 BLK
Vertical w/ Mounting Screws	BNC 9350 BLK	BNC 9359 BLK

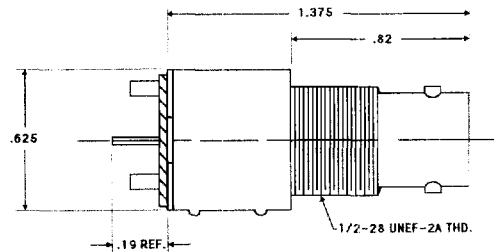

PANEL CUTOUT

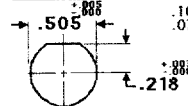

PCB HOLE PATTERN

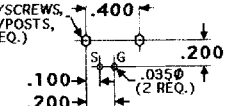

PCB Mount BNC Receptacles

BNC 7459 Low Profile Right Angle PCB Mount

Insulators - Polyethylene, Contact Plating - Gold,
Body - Die Cast Zinc Shell with Bright Nickel
Plating, White Valox Housing

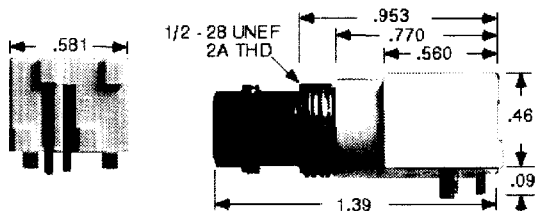

PANEL CUTOUT

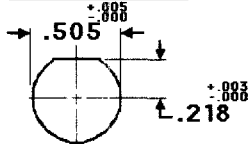

PCB HOLE PATTERN

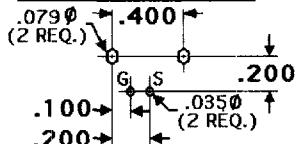

Vertical PCB Mount

Brass Contact -Plating Gold
Body - Screw Machined Brass with Nickel Plating

Part No.	Insulator
BNC6619	Teflon
BNC6659	Delrin



MOUNTING HOLE PATTERN

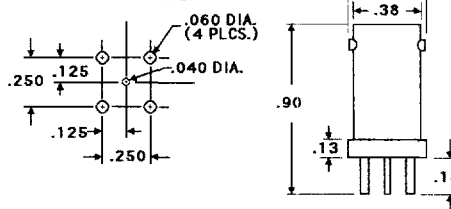

Mounting Hardware Packages for PCB Mount BNC and TNC Receptacles

PANEL THICKNESS	P/N For Insulated	P/N For Grounded	DIMENSIONS		
			O.D.	T	W
< .050 "	H-9103	H-9203	.625	.200	.562
.050 - .100	H-9100	H-9200	.625	.160	.625
.100 - .150	H-9101	H-9201	.625	.110	.625
.150 - .200	H-9102	H-9202	.625	.060	.625

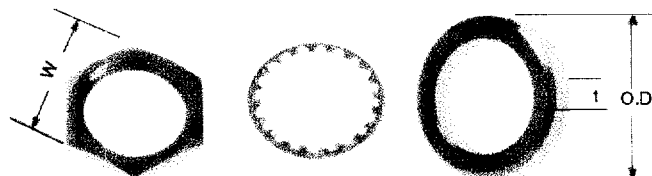

PCB Mount TNC Receptacles

PCB mount receptacles utilize a die cast zinc shell with bright nickel plating, polyethylene insulators, and either silver or gold plated contacts. The molded valox body features troughs that isolate the signal and ground leads and greatly reduce fluctuations in impedance. They are offered in right angle or vertical versions with either solder posts or screws for mounting, and with hardware packages for either panel grounding or insulating applications.

STYLE	FIG.	SILVER PLATED CONTACT	GOLD PLATED CONTACT
Right angled with mounting posts	FIG. 1	TNC 7054	TNC 7059
Right angled with mounting screws	FIG. 1	TNC 7154	TNC 7159
Vertical with mounting posts	FIG. 2	TNC 7254	TNC 7259
Vertical with mounting screws	FIG. 2	TNC 7354	TNC 7359

METAL MOUNTING THREADS

Figure 1

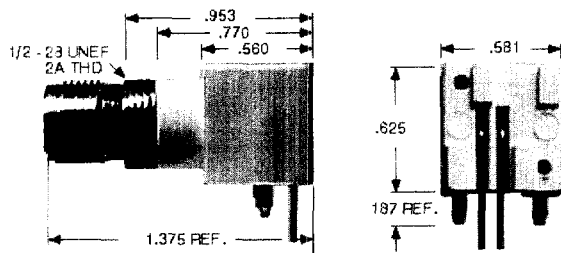
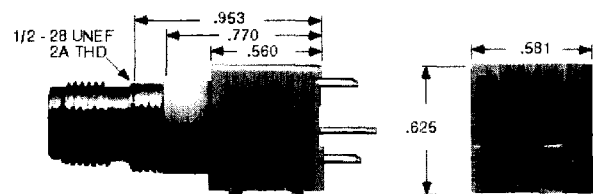
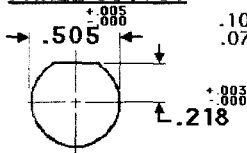

Figure 2



PANEL CUTOUT



PCB HOLE PATTERN

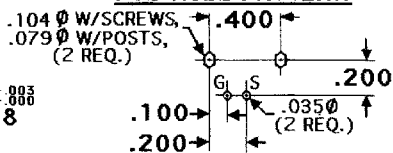

PANEL CUTOUT

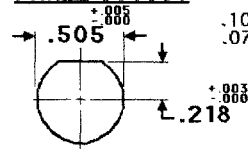

PCB HOLE PATTERN

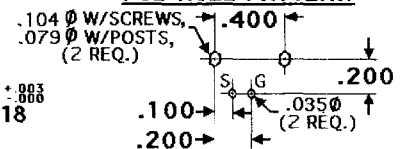

PLASTIC MOUNTING THREADS

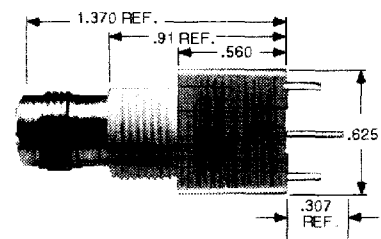
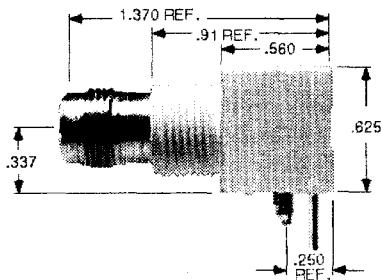

BLACK OR WHITE VALOX BODY "H" DIMENSION - .325		
STYLE	TIN PLATED CONTACT	GOLD PLATED CONTACT
Right Angle w/ Mounting Posts	TNC 9050 WHT	TNC 9059 WHT
Right Angle w/ Mounting Screws	TNC 9150 WHT	TNC 9159 WHT
Right Angle w/ Mounting Posts	TNC 9050 BLK	TNC 9059 BLK
Right Angle w/ Mounting Screws	TNC 9150 BLK	TNC 9159 BLK

BLACK OR WHITE VALOX BODY		
STYLE	TIN PLATED CONTACT	GOLD PLATED CONTACT
Vertical w/ Mounting Posts	TNC 9250 WHT	TNC 9259 WHT
Vertical w/ Mounting Screws	TNC 9350 WHT	TNC 9359 WHT
Vertical w/ Mounting Posts	TNC 9250 BLK	TNC 9259 BLK
Vertical w/ Mounting Screws	TNC 9350 BLK	TNC 9359 BLK

SEE PAGE 10 FOR MOUNTING HARDWARE

BNC Plugs - Panel Mount



Wire length to your specific ation

BNC 5554-X



BNC 5554



BNC 5754



BNC 5654

PRESS-FIT PANEL MOUNT BNC FOR RG 174

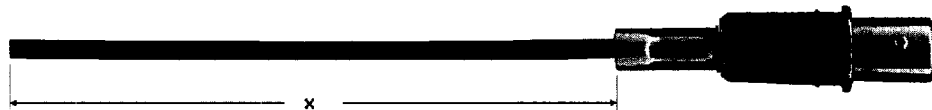

Wire length to your specific ation

BNC 6200HP

Panel Mount BNC Receptacles

Panel mount BNC receptacles are available in standard panel mount types (UG-625, UG-1094, and UG-1094A), isolated ground type, and an all new quick connect type. Center contacts are of 70/30 brass alloy with gold or silver plating, insulators are either teflon or polyethylene/valox. The BNC shell is available in die-cast zinc alloy or brass with a bright nickel plating. Standard impedance rating is 50 ohms. Contact the Sale's Office for further information on 75 ohm BNC connectors.

NTT PART NUMBER	DIMENSIONS (IN.)			FRONT/REAR MOUNTING HOLE	INSULATING MATERIAL	CONTACT PLATING	MILITARY NUMBER
	A	B	MAX. PANEL THICKNESS				
BNC 6054	.700	1.188	.125	A	Polyethylene/Valox	Silver	UG-625
BNC 6059	.700	1.188	.125	A	Polyethylene/Valox	Gold	UG-625
BNC 6154	.700	1.188	.125	B	Polyethylene/Valox	Silver	UG-1094
BNC 6159	.700	1.188	.125	B	Polyethylene/Valox	Gold	UG-1094
BNC 6119B*	.700	1.188	.125	B	Teflon	Gold	UG-1094
BNC 6254	.83	1.312	.225	B	Polyethylene/Valox	Silver	UG-1094A
BNC 6259	.83	1.312	.225	B	Polyethylene/Valox	Gold	UG-1094A
BNC 6219B*	.83	1.312	.225	B	Teflon	Gold	UG-1094A

*Brass Shell

**Supplied with Lock Washer and Nut.

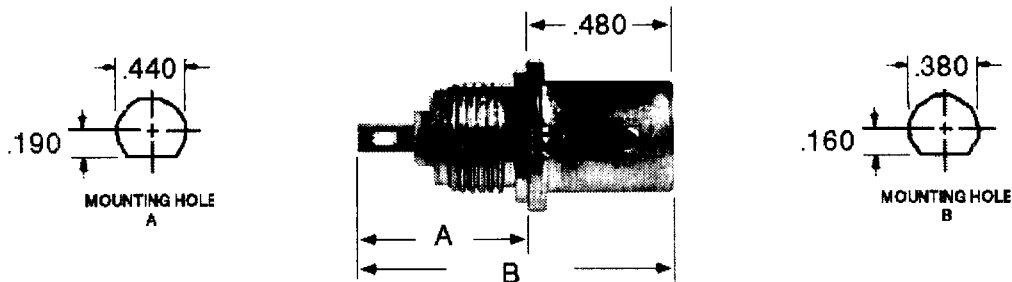

Panel Mount BNC Receptacles

Isolated Ground Panel Mount Receptacles*

BNC 6954

Silver Plated Contact, Valox Insulators

BNC 6959

Gold Plated Contact, Valox Insulators

BNC 6919B

Gold Plated Contact, Teflon Insulators, Brass Shell

*All supplied with Lock Washer and Nut.

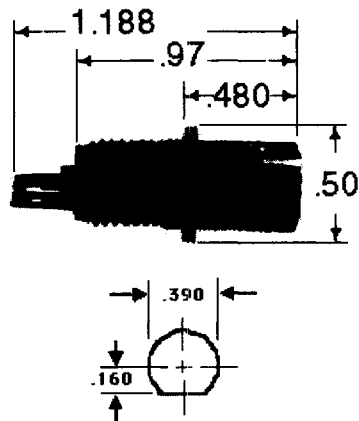

Quick-Connect BNC Receptacles

Quick Connect BNC Receptacles are designed for use with .110" series faston receptacles and can significantly reduce costly assembly time commonly encountered with solder type interconnections.

BNC 6154QC Silver Plated Contact, Die Cast Zinc Body

BNC 6159QC Gold Plated Contact, Die Cast Zinc Body

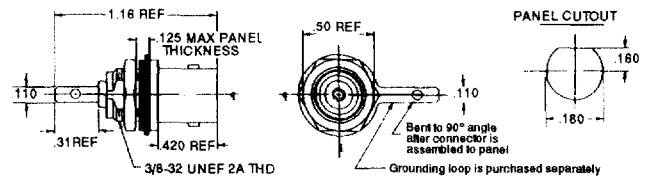

Panel Mount TNC Receptacles

Isolated Ground Panel Mount Receptacles*

TNC 6954B Silver Plated Contact, Valox Insulators

TNC 6959B Gold Plated Contact, Valox Insulators

TNC 6919B Gold Plated Contact, Teflon Insulators

*Supplied with Lock Washer and Nut.

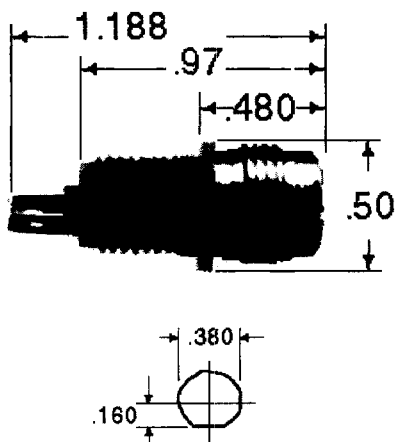

Quick-Connect TNC Receptacles

Quick Connect TNC Receptacles are designed for use with .110" series faston receptacles and can significantly reduce costly assembly time commonly encountered with solder type interconnections. Also available is a .110" Quick Connect faston terminal board that can be wave soldered into the printed circuit board for even greater savings.

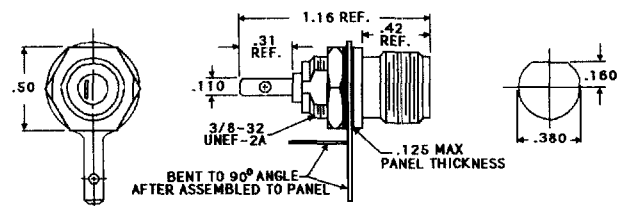

TNC 6154 Q.C. Silver Plated Contact, Polyethylene/Valox Insulators

TNC 6159 Q.C. Gold Plated Contact, Polyethylene/Valox Insulators

Panel Mount TNC Receptacles

Panel mount BNC receptacles are available in standard panel mount types (UG-625, UG-1094, and UG-1094A), isolated ground type, and an all new quick connect type. Center contacts are of 70/30 brass alloy with gold or silver plating, insulators are either teflon or polyethylene/valox. The BNC shell is available in die-cast zinc alloy or brass with a bright nickel plating. Standard impedance rating is 50 ohms. Contact the Sale's Office for further information on 75 ohm BNC connectors.

NTT PART NUMBER*	DIMENSIONS (IN.)			FRONT/REAR MOUNTING HOLE	INSULATING MATERIAL	CONTACT PLATING	MILITARY NUMBER
	A	B	MAX. PANEL THICKNESS				
TNC 6054	.312	1.188	.125	A	Polyethylene/Valox	Silver	UG-625
TNC 6059	.312	1.188	.125	A	Polyethylene/Valox	Gold	UG-625
TNC 6154	.312	1.188	.125	B	Polyethylene/Valox	Silver	UG-1094
TNC 6159	.312	1.188	.125	B	Polyethylene/Valox	Gold	UG-1094
TNC 6119B*	.312	1.188	.125	B	Teflon	Gold	UG-1094
TNC 6254	.440	1.312	.225	B	Polyethylene/Valox	Silver	UG-1094A
TNC 6259	.440	1.312	.225	B	Polyethylene/Valox	Gold	UG-1094A
TNC 6219B*	.440	1.312	.225	B	Teflon	Gold	UG-1094A

*Supplied with Lock Washer and Nut.

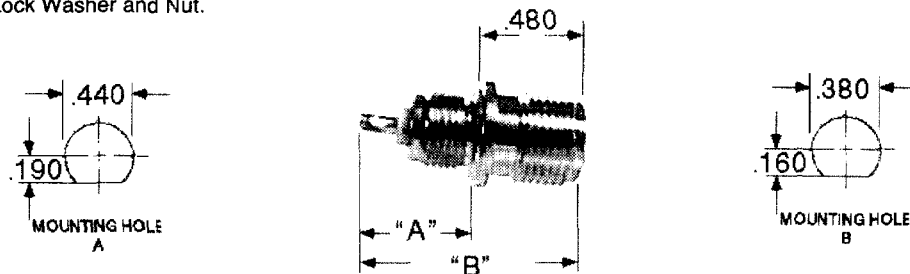

BNC/TNC Terminators

New commercial grade BNC and TNC Terminators are available in 50, 75, and 93 ohm impedance and utilize teflon insulators, gold plated contacts, and nickel plated brass bodies.

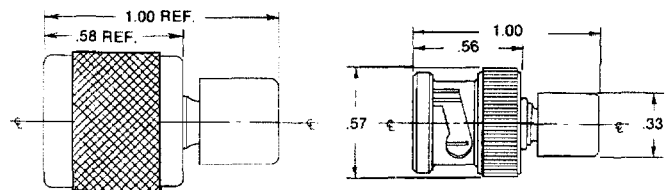
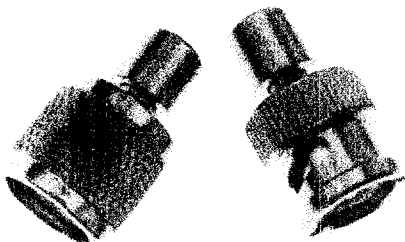

PART # **	IMPEDANCE	POWER RATING *
BNC 6719B	50 ohms $\pm 10\%$.5 Watts
BNC 67193B	50 ohms $\pm 1\%$.5 Watts
BNC 67191B	75 ohms $\pm 10\%$.5 Watts
BNC 67194B	75 ohms $\pm 1\%$.5 Watts
BNC 67192B	93 ohms $\pm 1\%$.5 Watts
TNC 6719B	50 ohms $\pm 10\%$.5 Watts
TNC 67193B	50 ohms $\pm 1\%$.5 Watts
TNC 67191B	75 ohms $\pm 10\%$.5 Watts
TNC 67194B	75 ohms $\pm 1\%$.5 Watts
TNC 67192B	75 ohms $\pm 1\%$.5 Watts

**Also available with chain. Add WC to part number.

*1/4 and 1 watt resistors available upon request.

Ntt-Smith 632 Arch Street Meadville, Pa. 16335
 Phone (814) 724-6440 FAX (814) 333-1912
 Quality Connectors and Cable Assemblies