

Wall Industries, Inc.

JR SERIES

2:1 Wide Input Voltage Ranges
Standard 2.0" x 1.0" x 0.4" Package
Single and Dual Outputs
10 Watt DC/DC Power Converters



FEATURES

- 10 Watts Maximum Output Power
- Single and Dual Outputs
- Standard 2.0" x 1.0" x 0.4" Package
- 2:1 Wide Input Voltage Ranges
- High Efficiency up to 87%
- No Minimum Load Requirement
- 1600VDC I/O Isolation
- Positive or Negative Remote ON/OFF Control Option
- Fixed Switching Frequency: 300KHz
- Over Voltage, Over Load, and Short Circuit Protected
- Extended Operating Temperature Range Available
- Six-Sided Continuous Shielding
- CE Mark Meets 2006/95/EC, 93/68/EEC, and 2004/108/EC
- UL60950-1, EN60950-1, and IEC60950-1 Safety Approvals
- Compliant to RoHS EU Directive 2002/95/EC
- UL94V-0 Compliant

APPLICATIONS

- Wireless Networks
- Telecom / Datacom
- Measurement Equipment
- Industry Control Systems
- Semiconductor Equipment

OPTIONS

- Positive Remote ON/OFF (Suffix "P")
- Negative Remote ON/OFF (Suffix "R")
- Extended Operating Temperature Range (Suffix "-I")
- Heatsink (Suffix "HS")

DESCRIPTION

The JR series of DC/DC power converters provides 10 watts of output power in a 2.0 x 1.0 x 0.4 inch industry standard package and footprint. This series has single and dual output models with 2:1 wide input voltage ranges of 9-18VDC, 18-36VDC, and 36-75VDC. Some features include high efficiency up to 87%, 1600VDC I/O isolation, and six-sided shielding. All models are also protected against over voltage, over load, and short circuit conditions. This series is RoHS and UL94V-0 compliant and has UL60950-1, EN60950-1, and IEC60950-1 safety approvals.



SPECIFICATIONS: JR SERIES						
All specifications are based on 25°C, Nominal Input Voltage, and Maximum Output Current unless otherwise noted. We reserve the right to change specifications based on technological advances.						
SPECIFICATION	TEST CONDITIONS		Min	Nom	Max	Unit
INPUT SPECIFICATIONS						
Input Voltage Range (See Note 1)	5 VDC nominal input models (minimum order quantities apply)		4.5	5	9	VDC
	12VDC nominal input models		9	12	18	
	24VDC nominal input models		18	24	36	
	48VDC nominal input models		36	48	75	
Input Surge Voltage (100ms max)	5 VDC nominal input models				15	VDC
	12VDC nominal input models				36	
	24VDC nominal input models				50	
	48VDC nominal input models				100	
Input Reflected Ripple Current				30		mAp-p
Input Filter			Pi type			
OUTPUT SPECIFICATIONS						
Output Voltage			See Table			
Line Regulation	Low line to high line at full load			±0.2		%
Load Regulation	No load to full load		Single Output Models	±0.5		%
			Dual Output Models	±1		
Cross Regulation (Dual Output Models)	Asymmetrical load 25% to 100% full load			±5		%
Voltage Accuracy				±1		%
Output Power					10	W
Output Current			See Table			
Minimum Load			0			%
Ripple & Noise (20MHz Bandwidth)	Nominal Vin and full load		Single Output Models	50		mVp-p
			Dual Output Models	75		
Transient Response Recovery Time	25% load step change			250		µs
Start-Up Time	Nominal Vin and constant resistive load		Power Up	20		ms
Temperature Coefficient					±0.02	%/°C
PROTECTION						
Over Voltage Protection	Zener diode clamp		3.3V output models		3.9	VDC
			5V output models		6.2	
			12V output models		15	
			15V output models		18	
Over Load Protection	% of full load at nominal input				150	%
Short Circuit Protection			hiccup, automatic recovery			
GENERAL SPECIFICATIONS						
Efficiency	Nominal Vin and full load		See Table			
Switching Frequency	Full load to minimum load		270	300	330	KHz
Isolation Voltage	Input to Output		1600			VDC
	Input to Case		1600			
	Output to Case		1600			
Isolation Resistance			1			GΩ
Isolation Capacitance					300	pF
REMOTE ON/OFF (See Note 7)						
Positive Logic (Suffix P)	DC/DC ON		Open or 3.5V < Vr < 12V			
	DC/DC OFF		Short or 0V < Vr < 1.2V			
Negative Logic (Suffix R)	DC/DC ON		Short or 0V < Vr < 1.2V			
	DC/DC OFF		Open or 3.5V < Vr < 12V			
Input Current of Remote Control Pin	Nominal Vin		-0.5		+1.0	mA
Remote Off State Input Current	Nominal Vin			20		mA
ENVIRONMENTAL SPECIFICATIONS						
Operating Ambient Temperature	Standard		With derating	-25	+85	°C
	"I" Version (suffix -I)		Without derating	-40	+85	
Maximum Case Temperature					+100	°C
Storage Temperature				-55	+105	°C
Thermal Impedance (See Note 9)	Natural convection				12	°C/Watt
	Natural convection with heatsink				10	
Relative Humidity (non-condensing)			5		95	% RH
Thermal Shock			MIL-STD-810F			
Vibration			MIL-STD-810F			
MTBF (See Note 2)	BELLCORE TR-NWT-000332		1,976,000 hours			
	MIL-HDBK-217F		1,416,000 hours			
PHYSICAL SPECIFICATIONS						
Weight			0.95oz (27g)			
Case Material			Nickel-coated copper			
Base Material			Non-conductive black plastic			
Potting Material			Epoxy (UL94V-0)			
Dimensions (L x W x H)			2.00 x 1.00 x 0.40 inches (50.8 x 25.4 x 10.2 mm)			
SAFETY & EMC CHARACTERISTICS						
Safety Approvals			UL60950-1, EN60950-1, IEC60950-1			
EMI (See Note 10)	EN55022		Class A			
ESD	EN61000-4-2		Air Contact	±8KV ±6KV		Perf. Criteria B
Radiated Immunity	EN61000-4-3			10 V/m		Perf. Criteria A
Fast Transient (See Note 11)	EN61000-4-4			±2KV		Perf. Criteria B
Surge (See Note 11)	EN61000-4-5			±1KV		Perf. Criteria B
Conducted Immunity	EN61000-4-6			10 Vrms		Perf. Criteria A

MODEL SELECTION TABLES

SINGLE OUTPUT MODELS										
Model ⁽¹⁾ Number	Input Voltage Range	Output Voltage	Output Current		Input Current		Output ⁽⁵⁾ Ripple & Noise	Output Power	Efficiency ⁽⁵⁾	Maximum ⁽⁶⁾ Capacitive Load
			Min. Load	Full Load	No Load ⁽⁴⁾	Full Load ⁽³⁾				
JR5S5-2000	5 VDC (4.5 – 9 VDC)	5 VDC	0mA	2000mA	-	2500mA	50mVp-p	10W	79%	7900µF
JR5S12-830		12 VDC	0mA	830mA	-	2350mA	50mVp-p	10W	82%	2200µF
JR5S15-660		15VDC	0mA	670mA	-	2348mA	50mVp-p	10W	82%	1470µF
JR12S33-2000	12 VDC (9 – 18 VDC)	3.3 VDC	0mA	2000mA	17mA	724mA	50mVp-p	6.6W	80%	6800µF
JR12S5-2000		5 VDC	0mA	2000mA	21mA	1082mA	50mVp-p	10W	81%	4700µF
JR12S12-830		12 VDC	0mA	830mA	38mA	1037mA	50mVp-p	10W	84%	690µF
JR12S15-660		15 VDC	0mA	670mA	36mA	1046mA	50mVp-p	10W	84%	470µF
JR24S33-2000	24 VDC (18 – 36 VDC)	3.3 VDC	0mA	2000mA	15mA	362mA	50mVp-p	6.6W	80%	6800µF
JR24S5-2000		5 VDC	0mA	2000mA	22mA	534mA	50mVp-p	10W	82%	4700µF
JR24S12-830		12 VDC	0mA	830mA	18mA	519mA	50mVp-p	10W	84%	690µF
JR24S15-660		15 VDC	0mA	670mA	36mA	523mA	50mVp-p	10W	84%	470µF
JR48S33-2000	48 VDC (36 – 75 VDC)	3.3 VDC	0mA	2000mA	11mA	181mA	50mVp-p	6.6W	80%	6800µF
JR48S5-2000		5 VDC	0mA	2000mA	14mA	260mA	50mVp-p	10W	84%	4700µF
JR48S12-830		12 VDC	0mA	830mA	14mA	253mA	50mVp-p	10W	86%	690µF
JR48S15-660		15 VDC	0mA	670mA	10mA	252mA	50mVp-p	10W	87%	470µF

DUAL OUTPUT MODELS										
Model ⁽¹⁾ Number	Input Voltage Range	Output Voltage	Output Current		Input Current		Output ⁽⁵⁾ Ripple & Noise	Output Power	Efficiency ⁽⁵⁾	Maximum ⁽⁶⁾ Capacitive Load
			Min. Load	Full Load	No Load ⁽⁴⁾	Full Load ⁽³⁾				
JR5D5-1000	5 VDC (4.5 – 9 VDC)	±5 VDC	0mA	±1000mA	-	2461mA	75mVp-p	10W	80%	±5060µF
JR5D12-420		±12 VDC	0mA	±416mA	-	2503mA	75mVp-p	10W	80%	±1034µF
JR5D15-330		±15VDC	0mA	±333mA	-	2393mA	75mVp-p	10W	81%	±660µF
JR12D5-1000	12 VDC (9 – 18 VDC)	±5 VDC	0mA	±1000mA	39mA	1042mA	75mVp-p	10W	84%	±680µF
JR12D12-420		±12 VDC	0mA	±416mA	47mA	1053mA	75mVp-p	10W	83%	±330µF
JR12D15-330		±15 VDC	0mA	±333mA	45mA	1041mA	75mVp-p	10W	84%	±110µF
JR24D5-1000	24 VDC (18 – 36 VDC)	±5 VDC	0mA	±1000mA	28mA	527mA	75mVp-p	10W	83%	±680µF
JR24D12-420		±12 VDC	0mA	±416mA	24mA	513mA	75mVp-p	10W	85%	±330µF
JR24D15-330		±15 VDC	0mA	±333mA	31mA	520mA	75mVp-p	10W	84%	±110µF
JR48D5-1000	48 VDC (36 – 75 VDC)	±5 VDC	0mA	±1000mA	16mA	260mA	75mVp-p	10W	84%	±680µF
JR48D12-420		±12 VDC	0mA	±416mA	19mA	254mA	75mVp-p	10W	86%	±330µF
JR48D15-330		±15 VDC	0mA	±333mA	16mA	256mA	75mVp-p	10W	85%	±110µF

NOTES

- Models with a 4.5~9VDC input voltage range require a minimum order.
- BELLCORE TR-NWT-000332. Case 1: 50% Stress, Temperature at 40°C.
MIL-HDBK-217F Notice2 @Ta=25°C, Full load (Ground, Benign, controlled environment).
- Maximum value at nominal input voltage and full load.
- Typical value at nominal input voltage and no load.
- Typical value at nominal input voltage and full load.
- Test by minimum Vin and constant resistive load.
- The on/off control pin is referenced to -Vin.
To order positive logic remote on/off, add the suffix "P" to the model number (Ex: JR24S15-660P).
To order negative logic remote on/off, add the suffix "R" to the model number (Ex: JR24S15-660R).
- "I" type models are more efficient; therefore, they can be operated over a more extensive temperature range than the standard version.
To order extended operating temperature range, add the suffix "-I" to the model number (Ex: JR24S15-660-I).
- Heatsink is optional and P/N: 7G-0020C-F.
- The JR series can meet EN55022 Class A with external capacitors in parallel connected to the input pins.
Recommended: 12Vin: 4.7µF/25V 1210 MLCC
24Vin: 2.2µF/50V 1812 MLCC
48Vin: 1.5µF/100V 1812 MLCC
- An external input filter capacitor is required if the module has to meet EN61000-4-4, EN61000-4-5. The filter capacitor suggested is Nippon chemi-con KY series, 220µF /100V, ESR 48mΩ.

CAUTION: This power module is not internally fused. An input line fuse must always be used.

CHARACTERISTICS

JR48S5-2000 Derating Curve

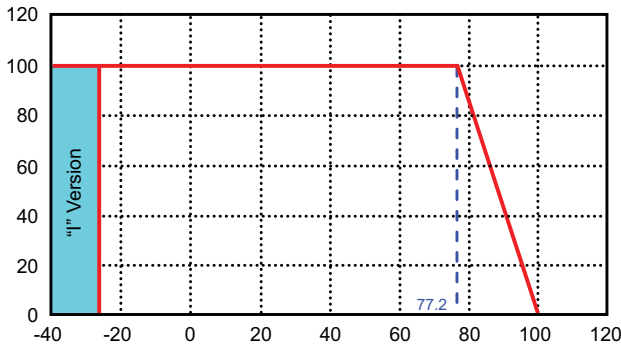

JR48S5-2000 Derating Curve with Heatsink

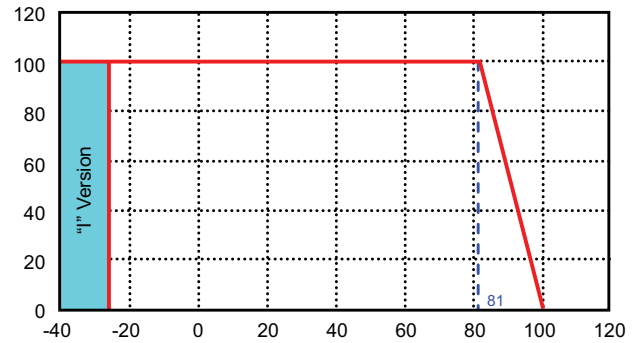

JR48S5-2000 Efficiency vs Input Voltage

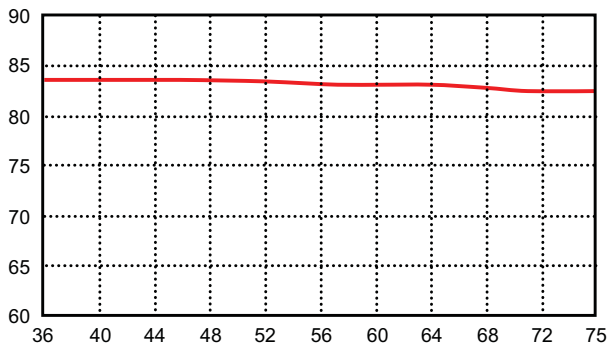

JR48S5-2000 Efficiency vs Output Load

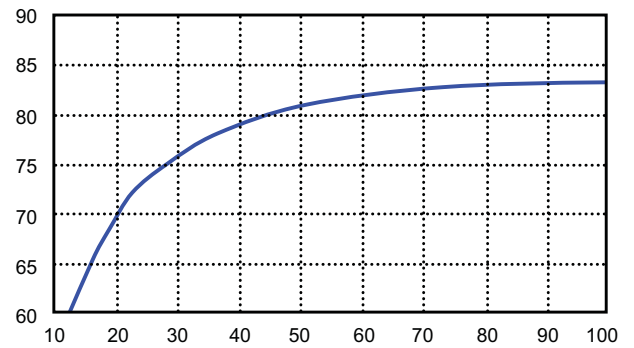

EMI FILTER

Recommended Filter for EN55022 Class B Compliance

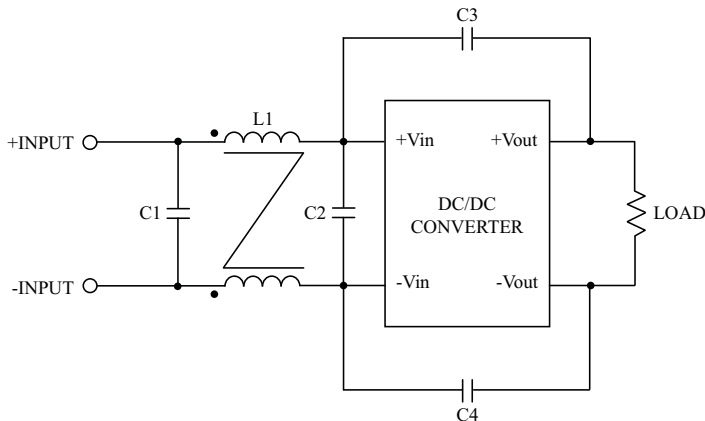

Recommended EN55022 Class B Filter Circuit Layout

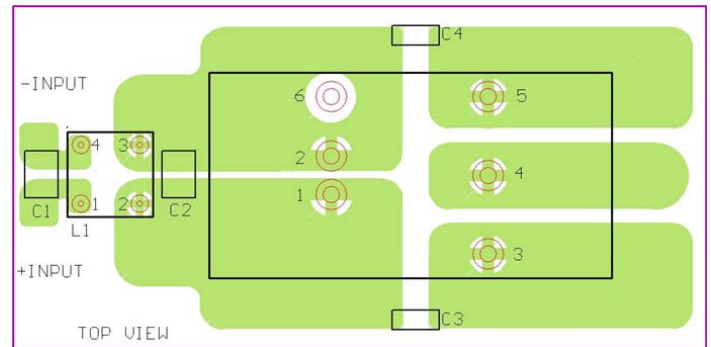

The components used in the figure above are as follows:

Model	C1	C2	C3	C4	L1
12VDC nominal input	3.3µF/50V 1812 MLCC	N/A	1000P/2KV MLCC	1000P/2KV MLCC	325µH Common Choke PMT-050
24VDC nominal input	2.2µF/50V 1812 MLCC	N/A	1000P/2KV MLCC	1000P/2KV MLCC	325µH Common Choke PMT-050
48VDC nominal input	2.2µF/100V 1812 MLCC	2.2µF/100V 1812 MLCC	1000P/2KV MLCC	1000P/2KV MLCC	325µH Common Choke PMT-050

MECHANICAL DRAWING

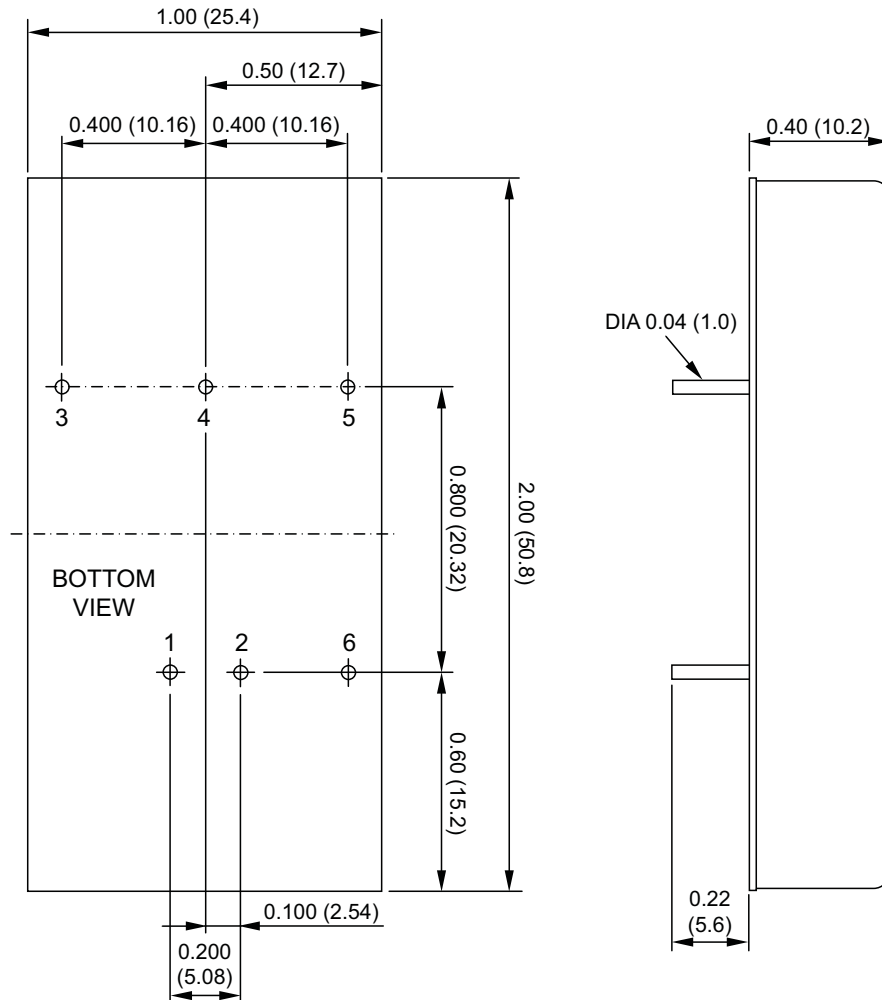

Unit: inches (mm)

PIN CONNECTIONS		
Pin	Single	Dual
1	+Input	+Input
2	-Input	-Input
3	+Output	+Output
4	No Pin	Common
5	-Output	-Output
6	CTRL (optional)	CTRL (optional)

Tolerance: X.XX±0.02 (X.X±0.5)
X.XXX±0.01 (X.XX±0.25)

Pin Pitch Tolerance: ±0.01 (±0.25)

COMPANY INFORMATION

Wall Industries, Inc. has created custom and modified units for over 50 years. Our in-house research and development engineers will provide a solution that exceeds your performance requirements on-time and on budget. Our ISO9001-2008 certification is just one example of our commitment to producing a high quality, well-documented product for our customers.

Our past projects demonstrate our commitment to you, our customer. Wall Industries, Inc. has a reputation for working closely with its customers to ensure each solution meets or exceeds form, fit and function requirements. We will continue to provide ongoing support for your project above and beyond the design and production phases. Give us a call today to discuss your future projects.

Contact **Wall Industries** for further information:

Phone: ☎ (603)778-2300
Toll Free: ☎ (888)587-9255
Fax: ☎ (603)778-9797
E-mail: sales@wallindustries.com
Web: www.wallindustries.com
Address: 5 Watson Brook Rd.
 Exeter, NH 03833