

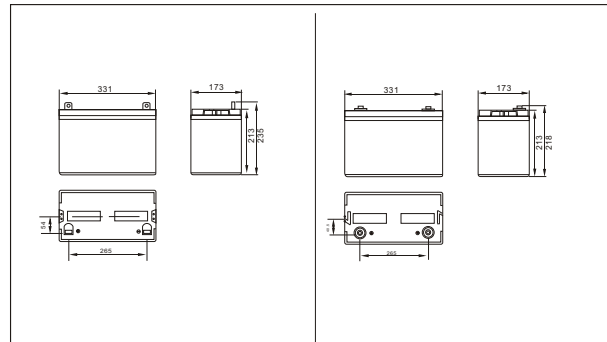

Sw121000(12V100AH)



Outer dimensions (mm)



Specifications

Nominal Voltage	12 V		
Rated capacity (10 hour rate)	100 Ah		
Dimensions	Total Height	T10	235 mm (9.25inches)
		T16	218 mm (8.58 inches)
	Height	213 mm (8.39inches)	
	Length	331 mm (13.0inches)	
	Width	173 mm (6.81 inches)	
Weight Approx	30.8 Kg (68.1 lbs)		

Terminal Type (mm)

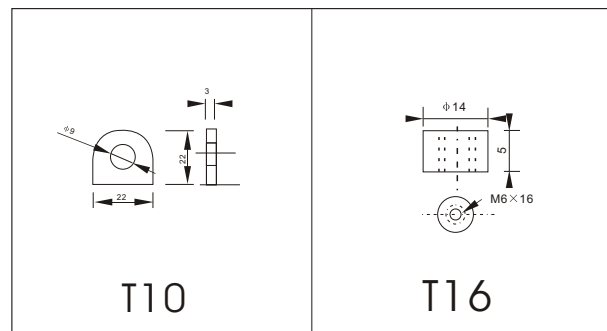

Characteristics

Capacity 25°C(77°F)	10 hour rate(10.0A) 5 hour rate(16.0A) 1 hour rate(60.0 A)	100 AH 80 AH 60 AH
Internal Resistance	Full charged Battery at 25°C(77°F)	approx 4.2 m Ω
Capacity affected by Temperature (10hour rate)	40°C(104°F) 25°C(77°F) 0°C(32°F) -15°C(5°F)	102% 100% 85% 65%
Self-Discharge at 25°C(77°F)	Capacity after 3 month storage Capacity after 6 month storage Capacity after 12 month storage	91% 82% 64%
Terminal	T10、T16	
Charge (constant Voltage)	Cycle	Initial Charging Current less than 40 A Voltage 14.10-14.40V
	Float	Voltage 13.50-13.80V

Discharge Curves 25°C(77°F)

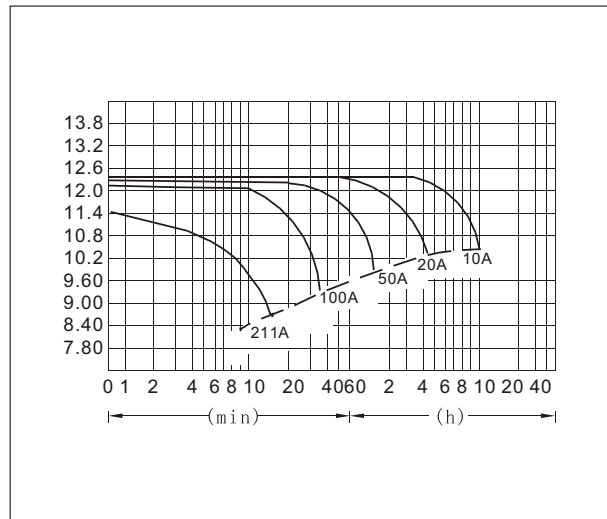

Constant Current(Amp) and Constant Power(Watt) Discharge Table at 25°C(77°F)

Time		5min	10min	15min	30min	1h	2h	3h	4h	5h	8h	10h	20h
960V	A	320.3	211.0	170.1	114.0	60.0	35.0	25.7	20.0	16.5	11.7	10.5	5.7
	W	3305.5	2253.5	1823.8	1225.7	648.0	384.3	286.0	225.0	187.6	134.1	121.3	65.9
1020V	A	310.2	190.4	160.2	109.0	56.4	33.4	25.0	19.5	16.2	11.4	10.3	5.5
	W	3312.9	2126.0	1792.6	1223.6	637.9	385.0	289.5	226.7	188.9	133.4	121.0	64.5
1050V	A	300.1	170.3	140.1	102.0	54.6	32.6	24.4	19.2	16.0	11.3	10.1	5.5
	W	3277.1	1937.3	1598.8	1173.8	632.3	378.1	284.3	224.6	187.6	132.9	119.5	65.0
1080V	A	289.2	160.5	130.2	94.0	52.8	31.8	23.8	18.9	15.6	11.0	10.0	5.4
	W	3244.8	1850.9	1499.9	1089.1	614.6	372.4	280.6	223.2	184.4	130.4	118.9	64.3
1110V	A	279.5	150.4	120.2	84.0	51.0	31.0	23.0	18.4	15.2	10.7	9.5	5.1
	W	3169.5	1741.6	1399.1	982.8	599.8	366.4	273.2	219.1	181.4	128.1	114.7	61.8

● Curves of cycle life(30°C)

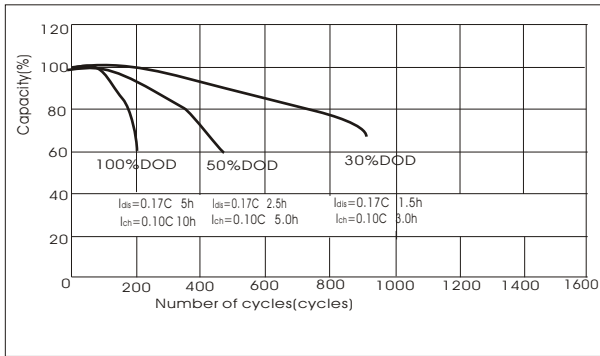

● Curves of cycle life(40°C)

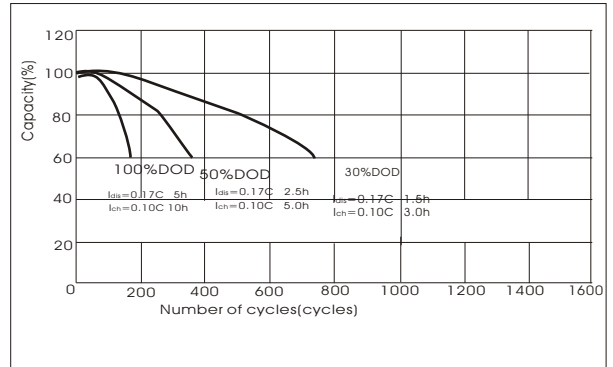

● Self-discharge characteristics(0-40°C)

