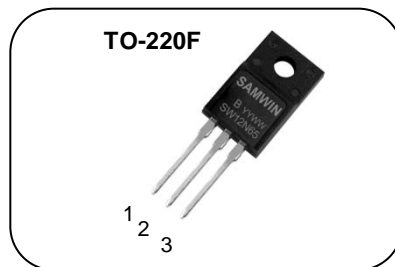
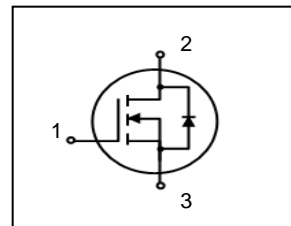

N-channel TO-220F MOSFET**Features**

- High ruggedness
- $R_{DS(ON)}$ (Max 0.85 Ω)@ $V_{GS}=10V$
- Gate Charge (Typical 28nC)
- Improved dv/dt Capability
- 100% Avalanche Tested

**1. Gate 2. Drain 3. Source**

BV_{DSS} : 650V
 I_D : 12.0A
 $R_{DS(ON)}$: 0.85ohm

**General Description**

This power MOSFET is produced with advanced VDMOS technology of SAMWIN. This technology enable power MOSFET to have better characteristics, such as fast switching time, low on resistance, low gate charge and especially excellent avalanche characteristics. It is mainly suitable for half bridge or full bridge resonant topology like a electronic ballast, and also low power switching mode power appliances.

Order Codes

Item	Sales Type	Marking	Package	Packaging
1	SW F 12N65B	SW12N65	TO-220F	TUBE

Absolute maximum ratings

Symbol	Parameter	Value	Unit
V_{DSS}	Drain to Source Voltage	650	V
I_D	Continuous Drain Current (@ $T_C=25^\circ C$)	12.0*	A
	Continuous Drain Current (@ $T_C=100^\circ C$)	7.6*	A
I_{DM}	Drain current pulsed (note 1)	48	A
V_{GS}	Gate to Source Voltage	± 30	V
E_{AS}	Single pulsed Avalanche Energy (note 2)	790	mJ
E_{AR}	Repetitive Avalanche Energy (note 1)	104	mJ
dv/dt	Peak diode Recovery dv/dt (note 3)	4.5	V/ns
P_D	Total power dissipation (@ $T_C=25^\circ C$)	54	W
	Derating Factor above 25°C	0.43	W/°C
T_{STG}, T_J	Operating Junction Temperature & Storage Temperature	-55 ~ + 150	°C
T_L	Maximum Lead Temperature for soldering purpose, 1/8 from Case for 5 seconds.	300	°C

*. Drain current is limited by junction temperature.

Thermal characteristics

Symbol	Parameter	Value	Unit
R_{thjc}	Thermal resistance, Junction to case	2.3	°C/W
R_{thcs}	Thermal resistance, Case to Sink	-	°C/W
R_{thja}	Thermal resistance, Junction to ambient	45.3	°C/W

Electrical characteristic ($T_C = 25^\circ\text{C}$ unless otherwise specified)

Symbol	Parameter	Test conditions	Min.	Typ.	Max.	Unit
Off characteristics						
BV_{DSS}	Drain to source breakdown voltage	$V_{GS}=0V, I_D=250\mu A$	650			V
$\Delta BV_{DSS} / \Delta T_J$	Breakdown voltage temperature coefficient	$I_D=250\mu A$, referenced to 25°C		0.8		$V/^\circ\text{C}$
I_{DSS}	Drain to source leakage current	$V_{DS}=650V, V_{GS}=0V$			1	μA
		$V_{DS}=520V, T_C=125^\circ\text{C}$			50	μA
I_{GSS}	Gate to source leakage current, forward	$V_{GS}=30V, V_{DS}=0V$			100	nA
	Gate to source leakage current, reverse	$V_{GS}=-30V, V_{DS}=0V$			-100	nA
On characteristics						
$V_{GS(TH)}$	Gate threshold voltage	$V_{DS}=V_{GS}, I_D=250\mu A$	2.0		4.0	V
$R_{DS(ON)}$	Drain to source on state resistance	$V_{GS}=10V, I_D = 6A$		0.7	0.85	Ω
G_{fs}	Forward Transconductance	$V_{DS} = 20 V, I_D = 6 A$	7			S
Dynamic characteristics						
C_{iss}	Input capacitance	$V_{GS}=0V, V_{DS}=25V, f=1\text{MHz}$		1450		pF
C_{oss}	Output capacitance			160		
C_{riss}	Reverse transfer capacitance			35		
$t_{d(on)}$	Turn on delay time	$V_{DS}=325V, I_D=12A, R_G=25\Omega$ (note 4, 5)		23	60	ns
t_r	Rising time			38	80	
$t_{d(off)}$	Turn off delay time			63	130	
t_f	Fall time			36	80	
Q_g	Total gate charge	$V_{DS}=520V, V_{GS}=10V, I_D=12A$ (note 4, 5)		28	50	nC
Q_{gs}	Gate-source charge			9		
Q_{gd}	Gate-drain charge			9		

Source to drain diode ratings characteristics

Symbol	Parameter	Test conditions	Min.	Typ.	Max.	Unit
I_S	Continuous source current	Integral reverse p-n Junction diode in the MOSFET			12	A
I_{SM}	Pulsed source current				48	A
V_{SD}	Diode forward voltage drop.	$I_S=12A, V_{GS}=0V$			1.5	V
T_{rr}	Reverse recovery time	$I_S=12A, V_{GS}=0V,$		456		ns
Q_{rr}	Reverse recovery Charge	$di_f/dt=100A/\mu s$		6.2		μC

※. Notes

1. Repetitive rating : pulse width limited by junction temperature.
2. $L = 11\text{mH}, I_{AS} = 12A, V_{DD} = 50V, R_G=25\Omega$, Starting $T_J = 25^\circ\text{C}$
3. $I_{SD} \leq 12.0A, di/dt = 100A/\mu s, V_{DD} \leq BV_{DSS}$, Starting $T_J = 25^\circ\text{C}$
4. Pulse Test : Pulse Width $\leq 300\mu s$, duty cycle $\leq 2\%$
5. Essentially independent of operating temperature.

Fig. 1. On-state characteristics

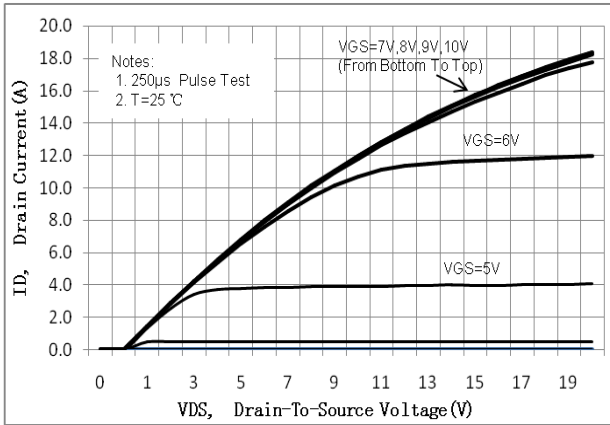

Fig. 2. On-resistance variation vs. drain current and gate voltage

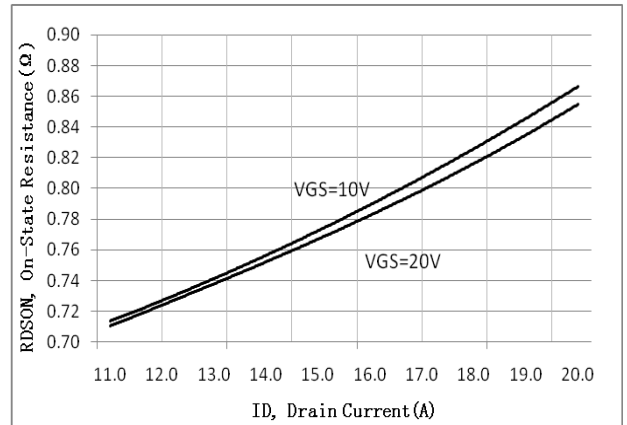

Fig. 3. Gate charge characteristics

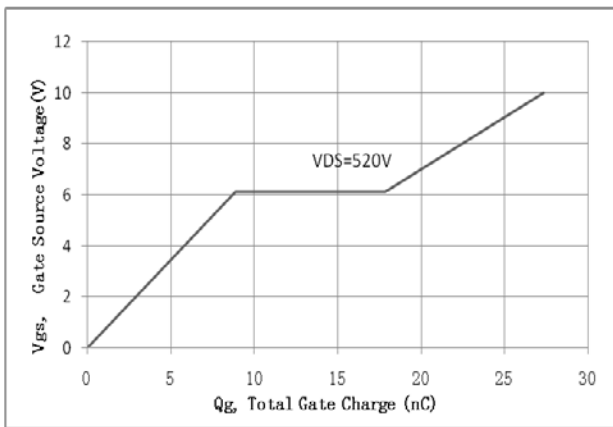

Fig. 4. On state current vs. diode forward voltage

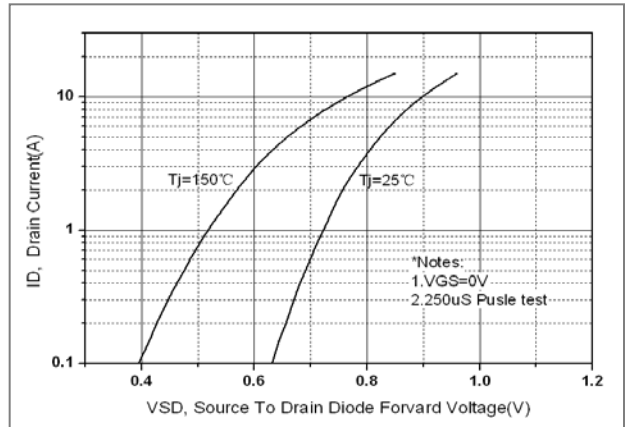

Fig 5. Breakdown Voltage Variation vs. Junction Temperature

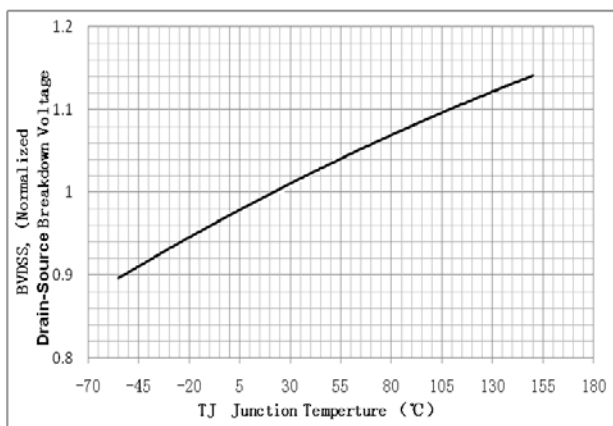

Fig. 6. On resistance variation vs. junction temperature



Fig. 7. Maximum safe operating area

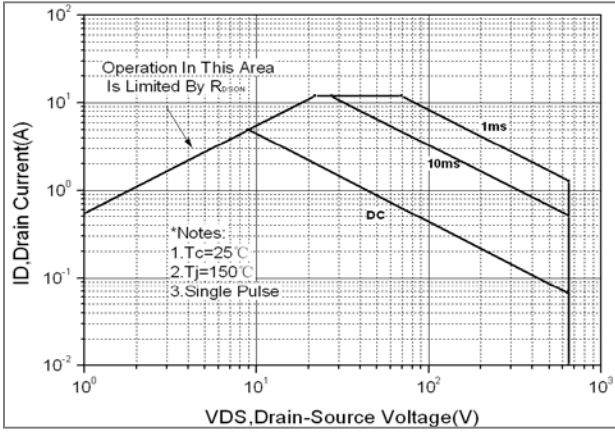

Fig. 8. Transient thermal response curve

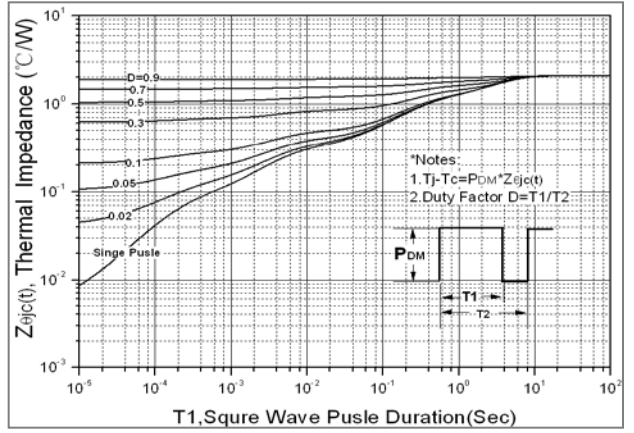

Fig. 9. Gate charge test circuit & waveform

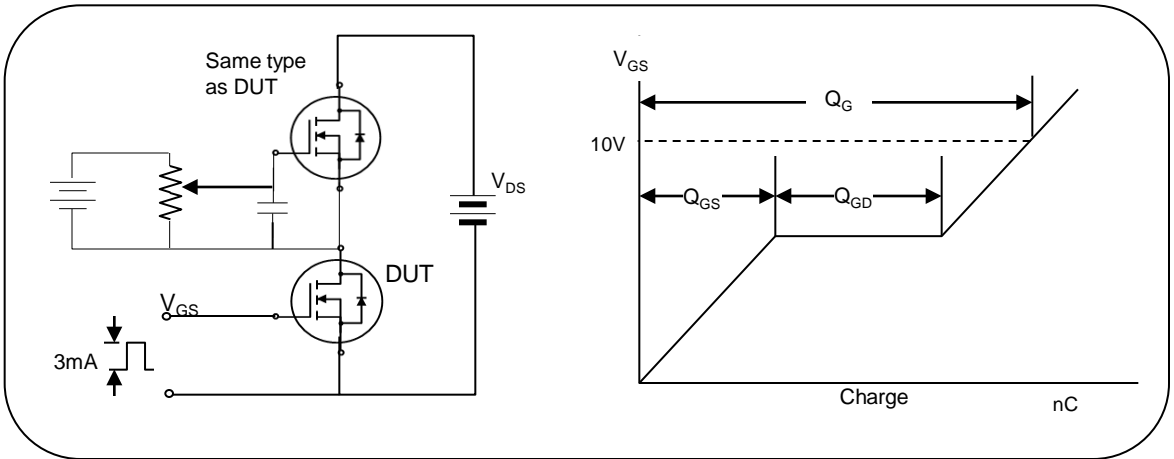

Fig. 10. Switching time test circuit & waveform

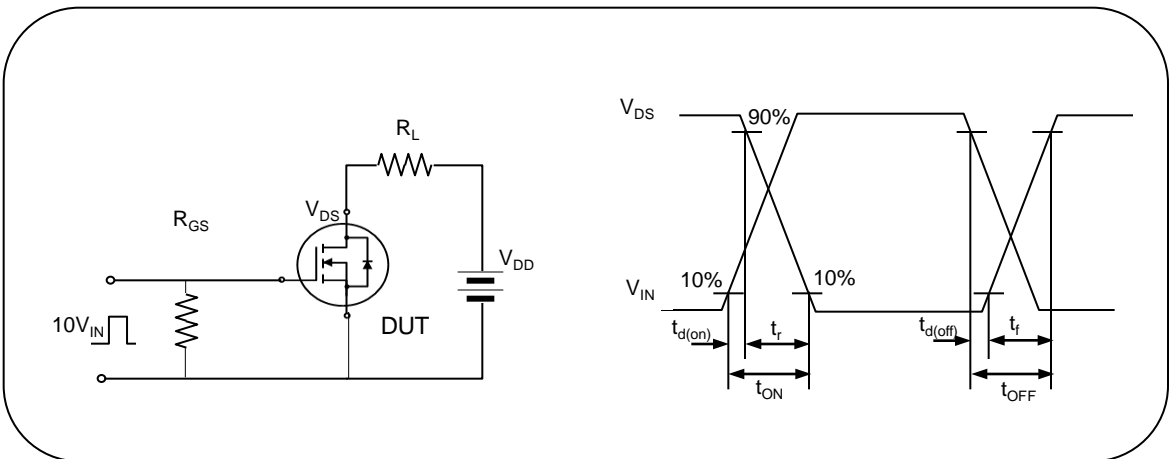

Fig. 11. Unclamped Inductive switching test circuit & waveform

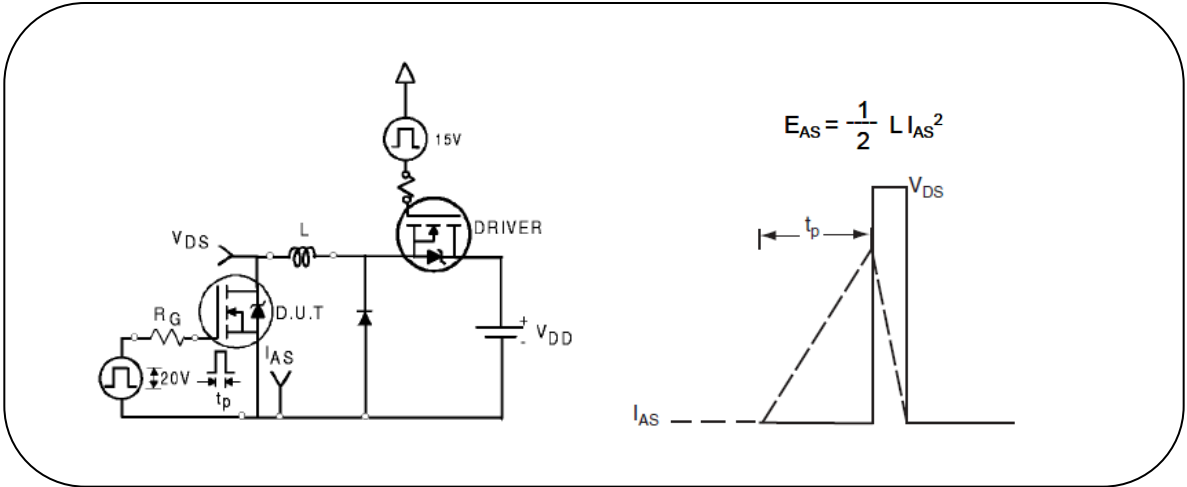

Fig. 12. Peak diode recovery dv/dt test circuit & waveform

