

# 1N5711, 1N5712, 5082-2800 Series

## Schottky Barrier Diodes for General Purpose Applications



### Data Sheet

#### Description/Applications

The 1N5711, 1N5712, 5082-2800/10/11 are passivated Schottky barrier diodes which use a patented "guard ring" design to achieve a high breakdown voltage. Packaged in a low cost glass package, they are well suited for high level detecting, mixing, switching, gating, log or A-D converting, video detecting, frequency discriminating, sampling, and wave shaping.

The 5082-2835 is a passivated Schottky diode in a low cost glass package. It is optimized for low turn-on voltage. The 5082-2835 is particularly well suited for the UHF mixing needs of the CATV marketplace.

#### Features

- Low Turn-On Voltage As Low as 0.34 V at 1 mA
- Pico Second Switching Speed
- High Breakdown Voltage Up to 70 V
- Matched Characteristics Available

#### Outline 15

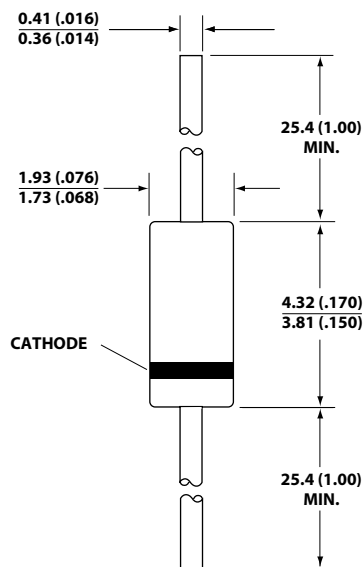

DIMENSIONS IN MILLIMETERS AND (INCHES).

#### Maximum Ratings

Junction Operating and Storage Temperature Range

1N5711, 1N5712, 5082-2800/10/11 ..... -65°C to +200°C

5082-2835 ..... -60°C to +150°C

DC Power Dissipation

(Measured in an infinite heat sink at  $T_{CASE} = 25^{\circ}C$ )

Derate linearly to zero at maximum rated temp.

1N5711, 1N5712, 5082-2800/10/11 ..... 250 mW

5082-2835 ..... 150 mW

Peak Inverse Voltage .....  $V_{BR}$

## Package Characteristics

### Outline 15

Lead Material .....	Dumet
Lead Finish .....	95-5% Tin-Lead
Max. Soldering Temperature .....	260°C for 5 sec
Min. Lead Strength .....	4 pounds pull
Typical Package Inductance	
1N5711, 1N5712:.....	2.0 nH
2800 Series:.....	2.0 nH
Typical Package Capacitance	
1N5711, 1N5712:.....	0.2 pF
2800 Series:.....	0.2 pF

The leads on the Outline 15 package should be restricted so that the bend starts at least 1/16 inch from the glass body.

Outline 15 diodes are available on tape and reel. The tape and reel specification is patterned after RS-296-D.

## Electrical Specifications at $T_A = 25^\circ\text{C}$

### General Purpose Diodes

Part Number	Package Outline	Min. Breakdown Voltage	Max. Forward Voltage	$V_F = 1\text{ V Max. at Forward Current}$	Max. Reverse Leakage Current		Max. Capacitance
		$V_{BR} (V)$	$V_F (mV)$	$I_F (mA)$	$I_R (nA) \text{ at } V_R (V)$		$C_T (pF)$
5082-2800	15	70	410	15	200	50	2.0
1N5711	15	70	410	15	200	50	2.0
5082-2810	15	20	410	35	100	15	1.2
1N5712	15	20	550	35	150	16	1.2
5082-2811	15	15	410	20	100	8	1.2
5082-2835	15	8*	340	10*	100	1	1.0
Test Conditions		$I_R = 10 \mu A$ $*I_R = 100 \mu A$	$I_F = 1\text{ mA}$	$*V_F = 0.45\text{ V}$			$V_R = 0\text{ V}$ $f = 1.0\text{ MHz}$

Note: Effective Carrier Lifetime ( $\tau$ ) for all these diodes is 100 ps maximum measured with Krakauer method at 5 mA except for 5082-2835 which is measured at 20 mA.

## Matched Pairs and Quads

Basic Part Number 5082-	Matched Pair Unconnected	Matched Quad Unconnected	Batch Matched <sup>[1]</sup>	Test Conditions
2800	5082-2804 $\Delta V_F = 20 \text{ mV}$	5082-2805 $\Delta V_F = 20 \text{ mV}$		$\Delta V_F$ at $I_F = 0.5, 5 \text{ mA}$ * $I_F = 10 \text{ mA}$ $\Delta C_O$ at $f = 1.0 \text{ MHz}$
2811			5082-2826 $\Delta V_F = 10 \text{ mV}$ $\Delta C_O = 0.1 \text{ pF}$	$\Delta V_F$ at $I_F = 10 \text{ mA}$ $\Delta C_O$ at $f = 1.0 \text{ MHz}$
2835			5082-2080 $\Delta V_F = 10 \text{ mV}$ $\Delta C_O = 0.1 \text{ pF}$	$\Delta V_F$ at $I_F = 10 \text{ mA}$ $\Delta C_O$ at $f = 1.0 \text{ MHz}$

Note:

1. Batch matched devices have a minimum batch size of 50 devices.

## SPICE Parameters

Parameter	Units	5082-2800	5082-2810	5082-2811	5082-2835
$B_V$	V	75	25	18	9
$C_{J0}$	pF	1.6	0.8	1.0	0.7
$E_G$	eV	0.69	0.69	0.69	0.69
$I_{BV}$	A	$10E-5$	$10E-5$	$10E-5$	$10E-5$
$I_S$	A	$2.2 \times 10E^{-9}$	$1.1 \times 10E^{-9}$	$0.3 \times 10E^{-8}$	$2.2 \times 10E^{-8}$
N		1.08	1.08	1.08	1.08
$R_S$	$\Omega$	25	10	10	5
$P_B$	V	0.6	0.6	0.6	0.56
$P_T$		2	2	2	2
M		0.5	0.5	0.5	0.5

## Typical Parameters

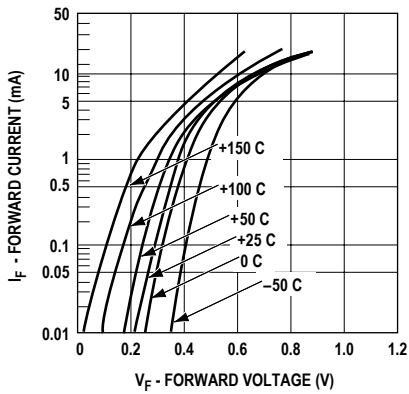

**Figure 1. I-V Curve Showing Typical Temperature Variation for 5082-2800 or 1N5711 Schottky Diodes.**

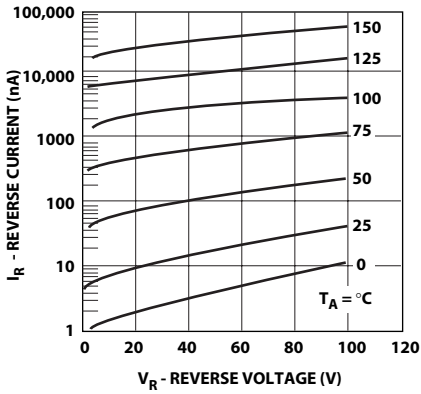

**Figure 2. (5082-2800 OR 1N5711) Typical Variation of Reverse Current ( $I_R$ ) vs. Reverse Voltage ( $V_R$ ) at Various Temperatures.**

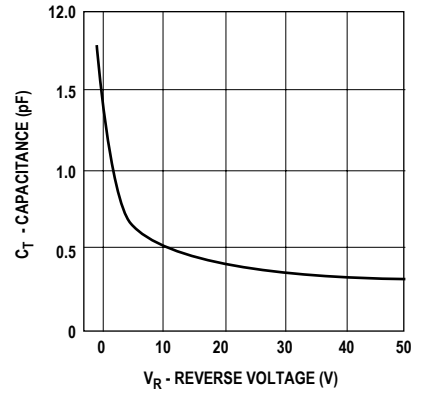

**Figure 3. (5082-2800 or 1N5711) Typical Capacitance ( $C_T$ ) vs. Reverse Voltage ( $V_R$ ).**

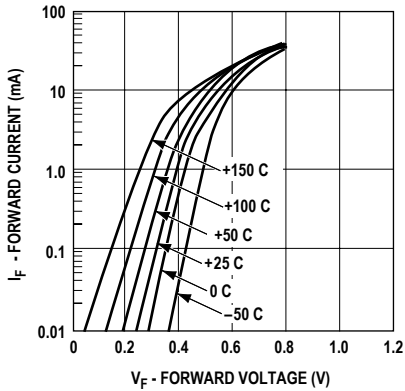

**Figure 4. I-V Curve Showing Typical Temperature Variation for the 5082-2810 or 1N5712 Schottky Diode.**

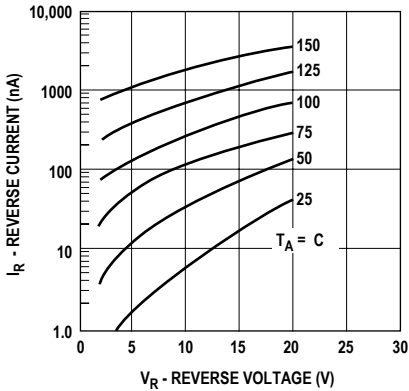

**Figure 5. (5082-2810 or 1N5712) Typical Variation of Reverse Current ( $I_R$ ) vs. Reverse Voltage ( $V_R$ ) at Various Temperatures.**

### Notes:

Typical values were derived using limited samples during initial product characterization and may not be representative of the overall distribution

Typical Parameters, *continued*

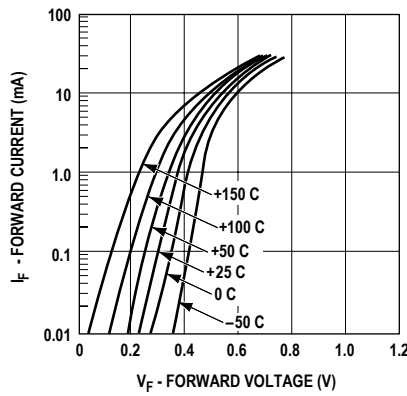

Figure 6. I-V Curve Showing Typical Temperature Variation for the 5082-2811 Schottky Diode.

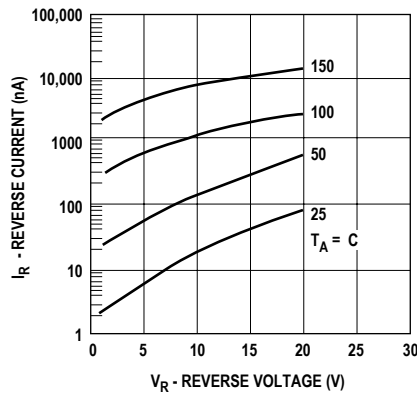

Figure 7. (5082-2811) Typical Variation of Reverse Current ( $I_R$ ) vs. Reverse Voltage ( $V_R$ ) at Various Temperatures.

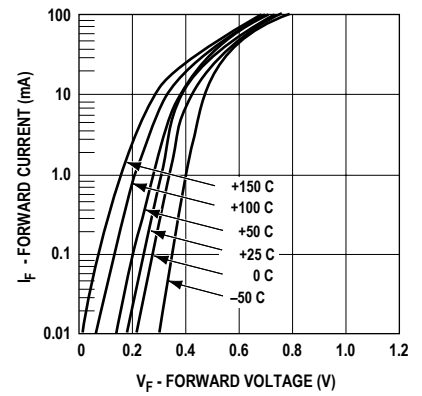

Figure 8. I-V Curve Showing Typical Temperature Variations for 5082-2835 Schottky Diode.

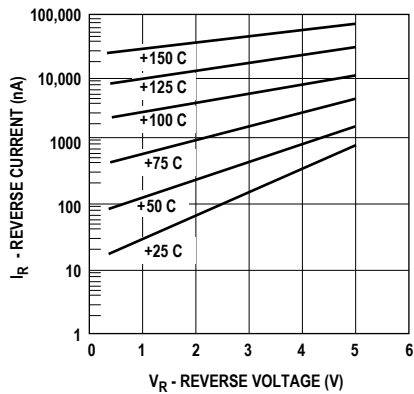

Figure 9. (5082-2835) Typical Variation of Reverse Current ( $I_R$ ) vs. Reverse Voltage ( $V_R$ ) at Various Temperatures.

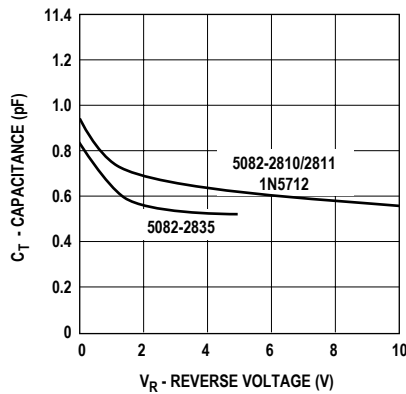

Figure 10. Typical Capacitance ( $C_T$ ) vs. Reverse Voltage ( $V_R$ ).

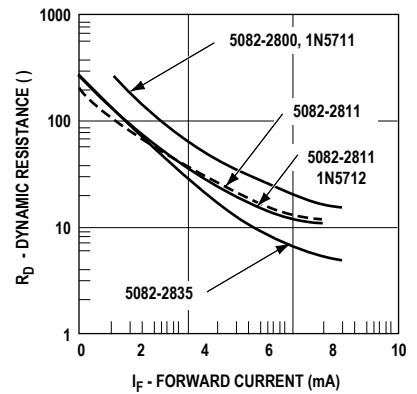

Figure 11. Typical Dynamic Resistance ( $R_D$ ) vs. Forward Current ( $I_F$ ).

Notes:

Typical values were derived using limited samples during initial product characterization and may not be representative of the overall distribution

### Tape Dimensions and Product Orientation

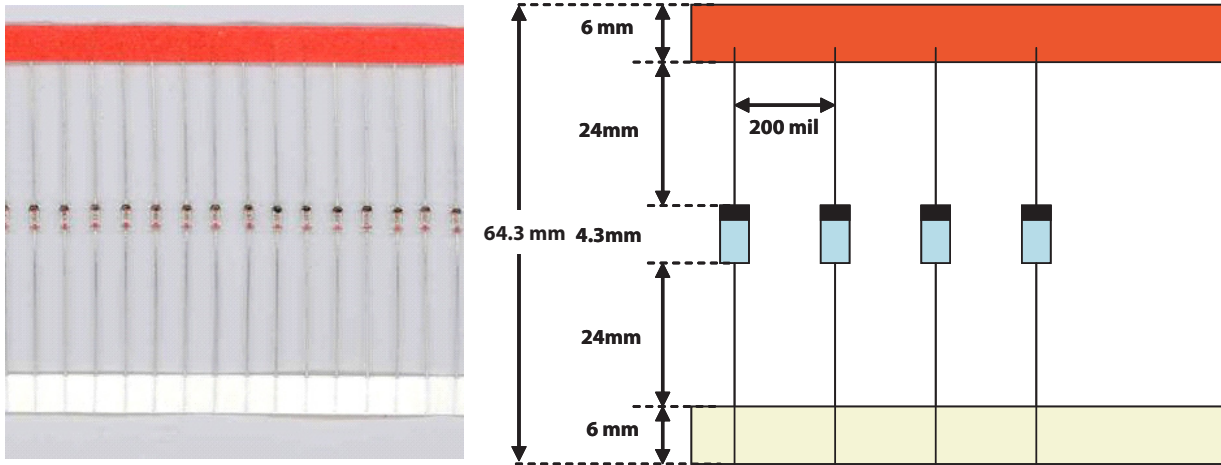

Figure 13.

### RFD Reel Dimensions for T25/T50

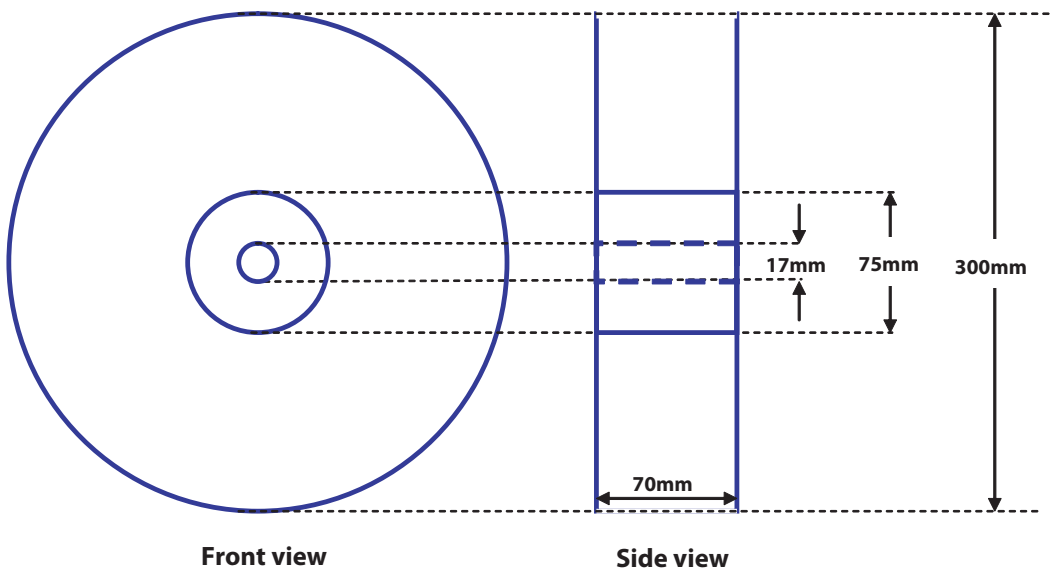

Figure 14.

### Diode Package Marking

1N5xxx                      5082-xxxx

would be marked:

1Nx                              xx

xxx                              xx

YWW                            YWW

where xxxx are the last four digits of the 1Nxxxx or the 5082-xxxx part number.

Y is the last digit of the calendar year. WW is the work week of manufacture.

Examples of diodes manufactured during workweek 45 of 1999:

1N5712                      5082-3080

would be marked:

1N5                              30

712                              80

945                              945

### Part Number Ordering Information

Part Number	No. of devices	Container
5082-28xx#T25/1N57xx#T25	2500	Tape & Reel
5082-28xx#T50/ 1N57xx#T50	5000	Tape & Reel
5082-28xx/ 1N57xx	100	Antistatic bag

For product information and a complete list of distributors, please go to our web site: [www.avagotech.com](http://www.avagotech.com)

Avago, Avago Technologies, and the A logo are trademarks of Avago Technologies, Limited in the United States and other countries. Data subject to change. Copyright © 2006 Avago Technologies, Limited. All rights reserved. Obsoletes 5989-3680EN AV02-0429EN - June 6, 2007

