



Micro Commercial Components

Micro Commercial Components
 20736 Marilla Street Chatsworth
 CA91311
 Phone: (818) 701-4933
 Fax: (818) 701-4939

ESD5V0J4

5 Volts ESD Protector

Features

- For sensitive ESD protection
- Excellent clamping capability
- Low leakage
- ESD rating of class 3(>16KV)per Human Body Mode
- For space saving application
- Fast response ,response time less than 1ns.
- Case Material: Molded Plastic. UL Flammability Classification Rating 94V-0

Maximum Ratings

- Operating Junction & Storage Temperature: -55°C to +150°C
- Maximum Thermal Resistance; 833°C/W Junction To Ambient

Parameter	Symbol	Limits	unit
IEC61000-4-2(ESD) Air Contact		±30 ±30	KV
ESD Voltage per human body mode per machine mode		16 400	KV V
Power Dissipation(Note 1)	Pd	150	mw
Peak Power Dissipation@8/20us	Ppk	200	W

1.Only 1 diode under power. For all 4 diodes under power, PD will be 25%. Mounted on FR--4 board with min pad.

Pin Configuration

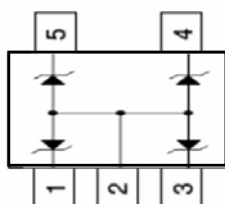

SOT-353

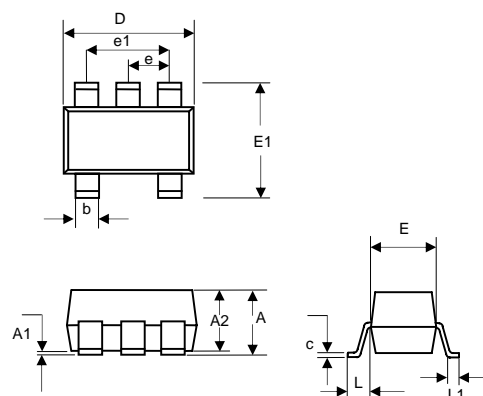

DIM	INCHES		MM	
	MIN	MAX	MIN	MAX
A	.035	.043	0.90	1.10
A1	.00	.004	.00	.100
A2	.035	.039	.900	1.00
b	.006	.014	.150	.350
c	.003	.006	.080	.150
D	.079	.087	2.0	2.2
E	.045	.053	1.15	1.35
E1	.085	.096	2.15	2.45
e	.026 TYP		.650 TYP	
e1	.047	.055	1.2	1.4
L	.021 REF		.525 REF	
L1	.010	.018	.260	.460

ELECTRICAL CHARACTERISTICS ($T_A = 25^\circ\text{C}$ unless otherwise noted, $V_F = 0.9\text{ V Max. @ } I_F = 10\text{mA}$ for all types)

Device*	Device Marking	V_{RWM} (V)	I_R (μA) @ V_{RWM}	V_{BR} (V) @ I_T		I_T	V_F (V) @ $I_F = 200\text{mA}$	V_C (V) @ Max $I_{PP} = 5\text{A}$	C (pF)
		Max	Max	Min	Max	mA	Max	Max	Typ
ESD5V0J4	12	5.0	5	6.0	7.2	1.0	1.25	12.5	90

TYPICAL CHARACTERISTICS

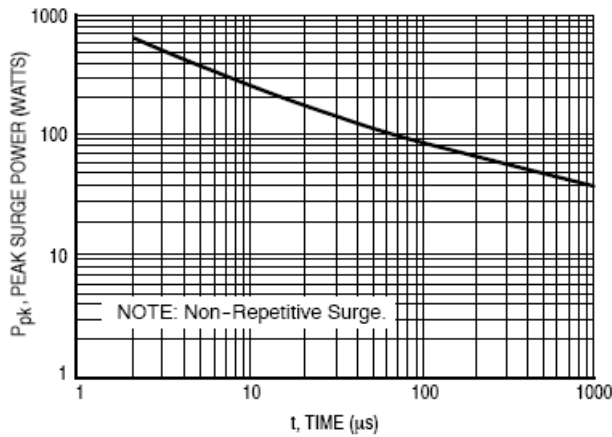

Figure 1. Pulse Width

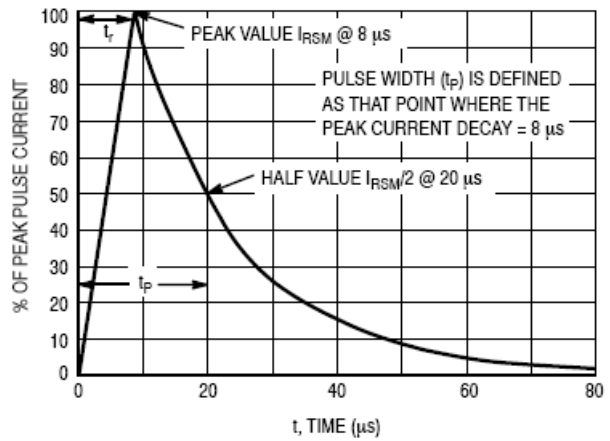

Figure 2. $8 \times 20 \mu\text{s}$ Pulse Waveform

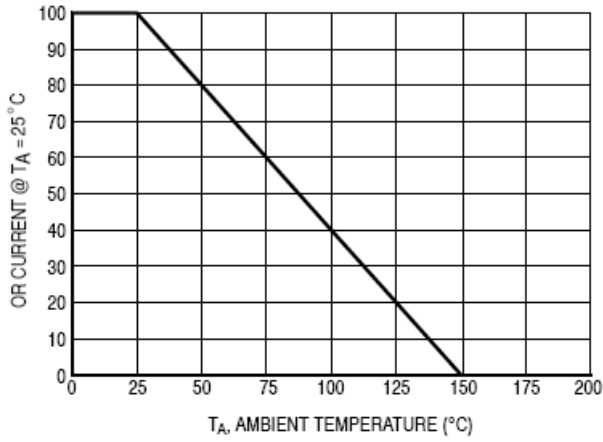

Figure 3. Pulse Derating Curve

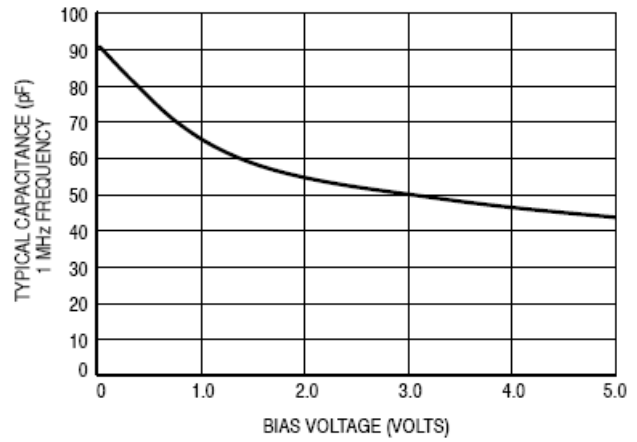

Figure 4. Capacitance

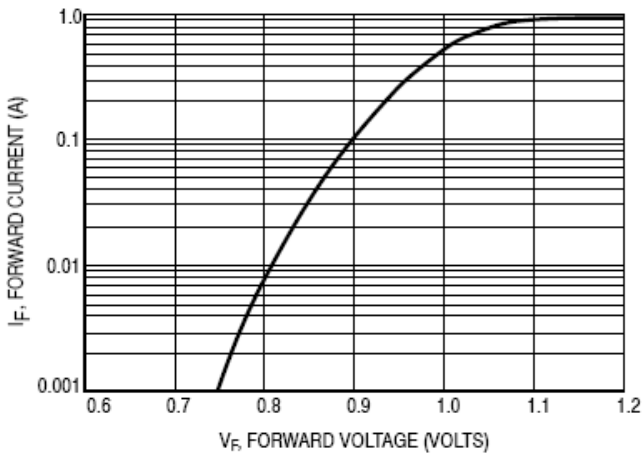

Figure 5. Forward Voltage

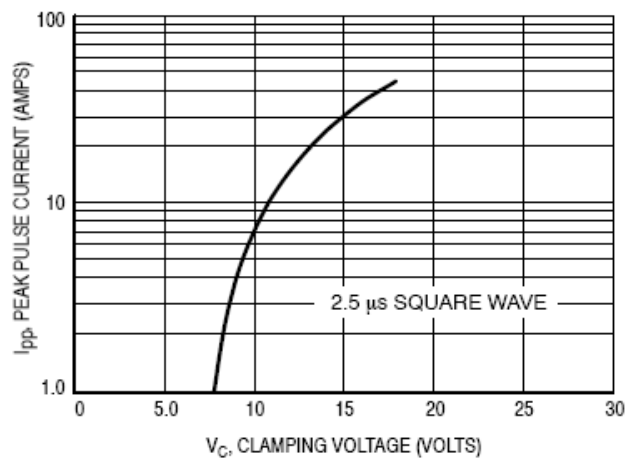

Figure 6. Clamping Voltage versus Peak Pulse Current (Reverse Direction)

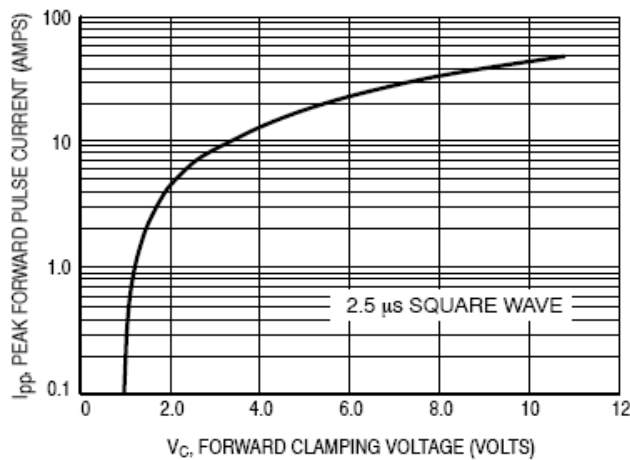

Figure 7. Clamping Voltage versus Peak Pulse Current (Forward Direction)



Micro Commercial Components

*****IMPORTANT NOTICE*****

Micro Commercial Components Corp. reserves the right to make changes without further notice to any product herein to make corrections, modifications, enhancements, improvements, or other changes. *Micro Commercial Components Corp.* does not assume any liability arising out of the application or use of any product described herein; neither does it convey any license under its patent rights, nor the rights of others. The user of products in such applications shall assume all risks of such use and will agree to hold *Micro Commercial Components Corp.* and all the companies whose products are represented on our website, harmless against all damages.

*****APPLICATIONS DISCLAIMER*****

Products offer by *Micro Commercial Components Corp.* are not intended for use in Medical, Aerospace or Military Applications.