

• **Low Frequency Power Amplifier**

- Complement to KSC2859

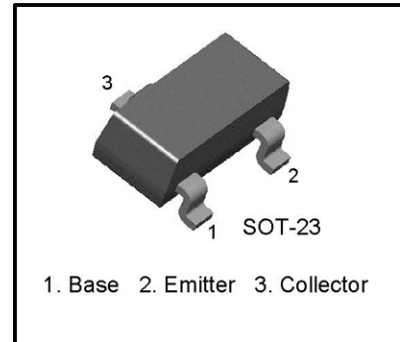

**PNP Epitaxial Silicon Transistor**

• **Absolute Maximum Ratings**  $T_a=25^\circ\text{C}$  unless otherwise noted

Symbol	Parameter	Ratings	Units
$V_{CBO}$	Collector-Base Voltage	-35	V
$V_{CEO}$	Collector-Emitter Voltage	-30	V
$V_{EBO}$	Emitter-Base Voltage	-5	V
$I_C$	Collector Current	-500	mA
$P_C$	Collector Power Dissipation	150	mW
$T_J$	Junction Temperature	150	$^\circ\text{C}$
$T_{STG}$	Storage Temperature	-55 ~ 150	$^\circ\text{C}$

• **Electrical Characteristics**  $T_a=25^\circ\text{C}$  unless otherwise noted

Symbol	Parameter	Test Condition	Min.	Typ.	Max.	Units
$I_{CBO}$	Collector Cut-off Current	$V_{CB} = -35\text{V}, I_E = 0$			-0.1	$\mu\text{A}$
$I_{EBO}$	Emitter Cut-off Current	$V_{EB} = -5\text{V}, I_C = 0$			-0.1	$\mu\text{A}$
$h_{FE1}$ $h_{FE2}$	DC Current Gain	$V_{CE} = -1\text{V}, I_C = -100\text{mA}$ $V_{CE} = -6\text{V}, I_C = -400\text{mA}$	70 25		240	
$V_{CE(sat)}$	Collector-Emitter Saturation Voltage	$I_C = -100\text{mA}, I_B = -10\text{mA}$		-0.1	-0.25	V
$V_{BE(on)}$	Base-Emitter On Voltage	$V_{CE} = -1\text{V}, I_C = -100\text{mA}$		-0.8	-1.0	V
$f_T$	Current Gain Bandwidth Product	$V_{CE} = -6\text{V}, I_C = -20\text{mA}$		200		MHz
$C_{ob}$	Output Capacitance	$V_{CB} = -6\text{V}, I_E = 0, f = 1\text{MHz}$		13		pF

•  **$h_{FE}$  Classification**

Classification	O	Y
$h_{FE1}$	70 ~ 140	120 ~ 240

Marking

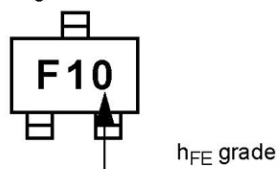

Typical Characteristics

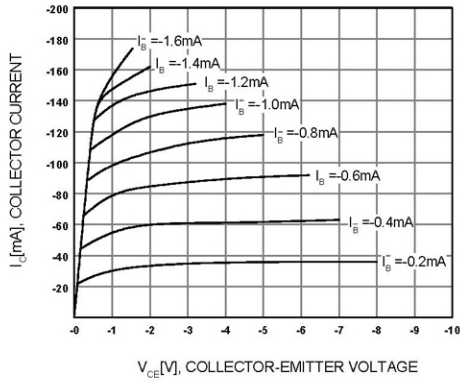

Figure 1. Static Characteristic

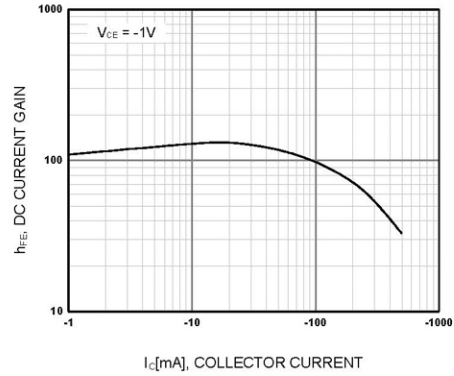

Figure 2. DC current Gain

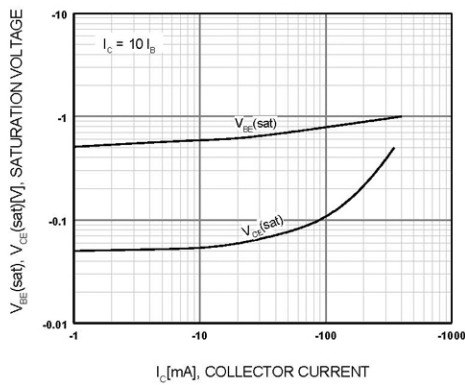

Figure 3. Base-Emitter Saturation Voltage  
Collector-Emitter Saturation Voltage

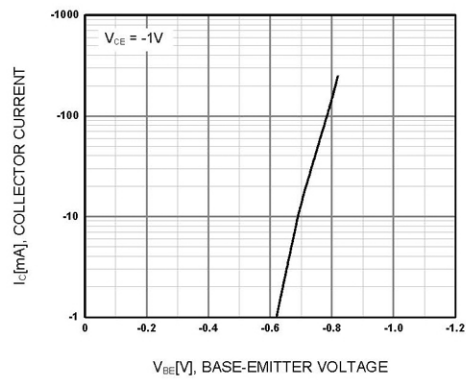

Figure 4. Base-Emitter On Voltage

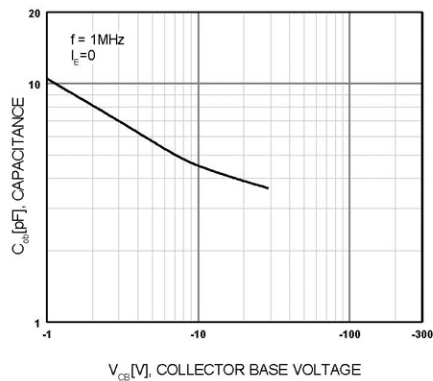

Figure 5. Collector Output Capacitance

## Package Dimensions

### SOT-23

