



Features

- Formerly J.W. Miller® model
- Available in E12 series
- Low profile of only 3.2 mm
- Low inductance values
- RoHS compliant*

Applications

- Input/output of DC/DC converters
- Power supplies for:
 - Portable communication equipment
 - Camcorders
 - LCD TVs
 - Car radios

PM43 Series - SMD Power Inductor

Electrical Specifications

Bourns Part No.	Inductance 1 kHz		Q Ref.	Test Frequency (MHz)	SRF Min. (MHz)	RDC (Ω)	I rms Max. (A)	I sat Typ. (A)
	(μH)	Tol. %						
PM43-1R0M-RC	1.0	± 20	28	7.96	150	0.033	3.80	5.50
PM43-1R4M-RC	1.4	± 20	28	7.96	110	0.038	3.30	5.10
PM43-1R8M-RC	1.8	± 20	28	7.96	90	0.042	2.91	4.40
PM43-2R2M-RC	2.2	± 20	28	7.96	80	0.047	2.60	3.90
PM43-2R7M-RC	2.7	± 20	28	7.96	75	0.052	2.43	3.50
PM43-3R3M-RC	3.3	± 20	28	7.96	65	0.058	2.15	3.00
PM43-3R9M-RC	3.9	± 20	28	7.96	55	0.076	1.98	2.70
PM43-4R7M-RC	4.7	± 20	28	7.96	50	0.094	1.70	2.60
PM43-5R6M-RC	5.6	± 20	28	7.96	45	0.10	1.60	2.40
PM43-6R8M-RC	6.8	± 20	28	7.96	40	0.12	1.41	2.10
PM43-8R2M-RC	8.2	± 20	28	7.96	36	0.13	1.26	1.90
PM43-100M-RC	10	± 20	28	2.52	33	0.18	1.15	1.70
PM43-120M-RC	12	± 20	28	2.52	30	0.21	1.05	1.60
PM43-150M-RC	15	± 20	28	2.52	28	0.24	0.92	1.40
PM43-180M-RC	18	± 20	25	2.52	23	0.34	0.84	1.30
PM43-220M-RC	22	± 20	25	2.52	20	0.38	0.76	1.20
PM43-270K-RC	27	± 10	23	2.52	17	0.52	0.71	1.00
PM43-330K-RC	33	± 10	23	2.52	15	0.54	0.64	0.99
PM43-390K-RC	39	± 10	20	2.52	14	0.59	0.59	0.92
PM43-470K-RC	47	± 10	20	2.52	13	0.84	0.54	0.78
PM43-560K-RC	56	± 10	20	2.52	12	0.94	0.50	0.74
PM43-680K-RC	68	± 10	20	2.52	11	1.12	0.46	0.68

General Specifications

Test Voltage 1 V
 Reflow Soldering .. 230 °C, 50 sec. max.
 Operating Temperature -40 °C to +125 °C
 (Temperature rise included)
 Storage Temperature -40 °C to +125 °C
 Resistance to Soldering Heat 260 °C for 5 sec.

Materials

Core Ferrite DR
 Wire Enameled copper wire 130
 Terminal Ag/Ni/Sn
 Rated Current Ind. drop 10 % typ. at Isat
 Temperature Rise 40 °C max
 at rated I rms
 Packaging 1500 pcs. per reel

Product Dimensions

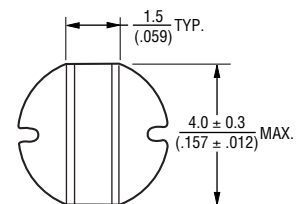
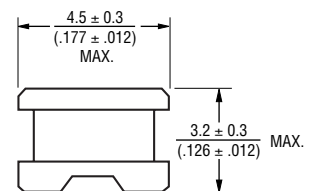

Typical Part Marking

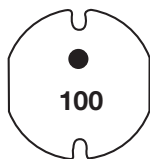

Electrical Schematic

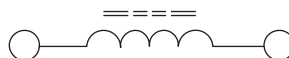

Recommended Layout

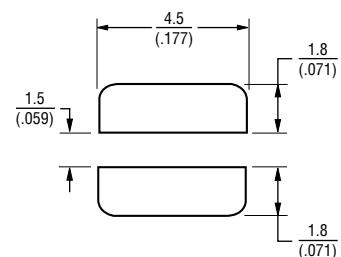

DIMENSIONS: $\frac{\text{MM}}{\text{(INCHES)}}$

*RoHS Directive 2002/95/EC Jan. 27, 2003 including annex and RoHS Recast 2011/65/EU June 8, 2011. Specifications are subject to change without notice. Customers should verify actual device performance in their specific applications.

PM43 Series - SMD Power Inductor

BOURNS®

Packaging Specifications

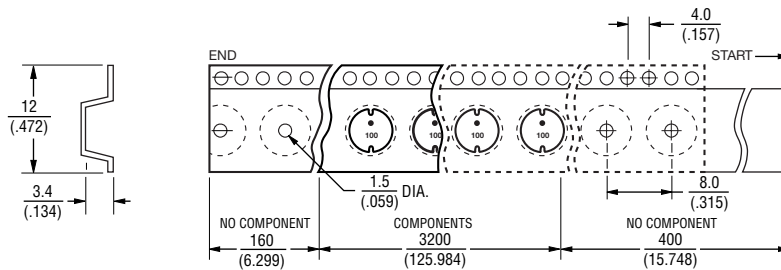
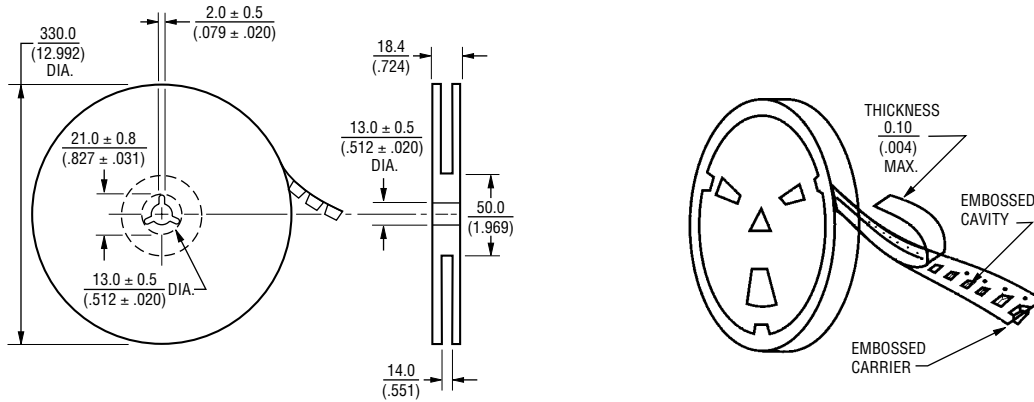

USER DIRECTION OF FEED →

QTY: 1500 PCS. PER REEL

DIMENSIONS: $\frac{\text{MM}}{\text{(INCHES)}}$

REV. 05/09

Specifications are subject to change without notice.
Customers should verify actual device performance in their specific applications.