

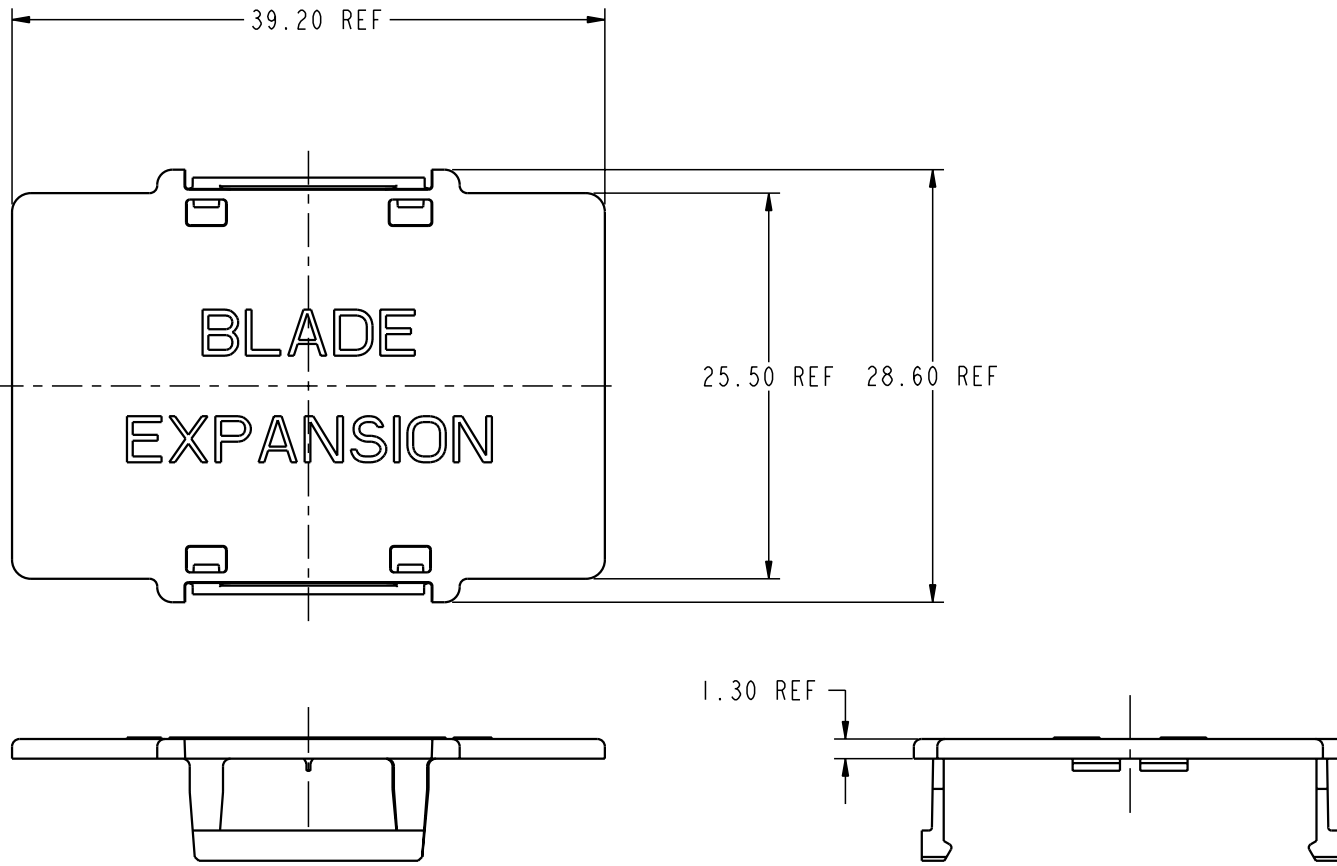



Tous droits strictement reserves. Reproduction ou communication a des tiers interdite sous quelque forme que ce soit sans autorisation ecrite du proprietaire. Propriete de c FCI. Droits de reproduction FCI.

All rights strictly reserved. Reproduction or issue to third parties in any form whatever is not permitted without written authority from the proprietor. Property of FCI. Copyright FCI.

A
FCI

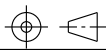

mat'l code				SEE NOTE 1		tolerances unless otherwise specified		CUSTOMER		 www.fciconnect.com	
ltr	ecr no.	dr	date	linear	0.X ±0.3		COPY		title GIG-Array 200 POS. PROTECTIVE CAP		
A	V04-1041	TAB	10/19/04		0.XX ±0.10		projection				
					0.XXX ±0.050						
				angles	0° ±2°		 MM		product family GIG-Array code 213		
				dr	T. BRUNGARD	08/04/04	scale 2:1		size A		sheet 1 of 2
				enr	M. STRAWSER	07/19/04			dwg no 10042774		
				chr	M. STRAWSER	08/04/04					
				appd	M. STRAWSER	08/04/04					
sheet index	revision sheet	A	A								
1	2										

Pro/E

cage code 22526

PDM: Rev:A

STATUS: Released

Printed: Oct 30, 2004

Tous droits strictement reserves. Reproduction ou communication a des tiers interdite sous quelque forme que ce soit sans autorisation écrite du propriétaire. Propriete de c FCI. Droits de reproduction FCI.

FCI

All rights strictly reserved. Reproduction or issue to third parties in any form whatever is not permitted without written authority from the proprietor. Property of FCI. Copyright FCI.

PRODUCT NUMBER	COMMENTS
10042774-001	NO VERBIAGE
10042774-002	BLADE EXPANSION VERBIAGE ③
10042774-003	SPECIAL PACKAGING AND BLADE EXPANSION VERBIAGE ③

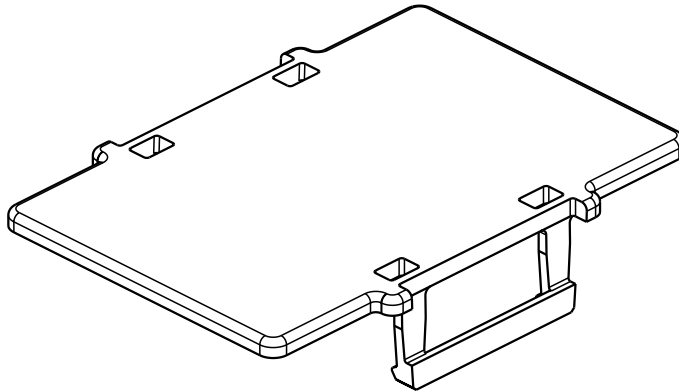

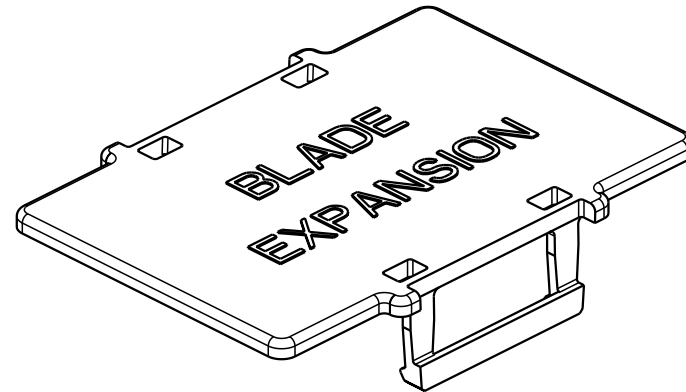

10042774-001
SCALE 2:1



10042774-002 & -003
SCALE 2:1

NOTES:

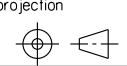
- ① MATERIAL:
LCP
COLOR: BLACK
UL RATING: 94 V-0
- 2. THIS PROTECTIVE CAP SHOULD NOT BE USED AS A PICK & PLACE CAP DURING REFLOW.
- ③ RAISED ENGRAVING "BLADE EXPANSION" USE 12pt. HELVETICA FONT, CENTER JUSTIFIED.

mat'l code				SEE NOTE 1		tolerances unless otherwise specified		CUSTOMER		 www.fciconnect.com	
ltr	ecr no.	dr	date	linear	0.X ±0.3		COPY		projection	title	
A	-	-	-		0.XX ±0.10					GIG-Array 200 POS. PROTECTIVE CAP	
					0.XXX ±0.050					product family GIG-Array code 213	
				angles	0° ±2°		scale		size dwg no		
				dr	T. BRUNGARD	08/04/04	1:1		A 10042774		
				enr	M. STRAWSER	07/19/04			sheet 2		
				chr	M. STRAWSER	08/04/04					
				appd	M. STRAWSER	08/04/04					
sheet index	revision sheet										

Pro/E

cage code 22526

PDM: Rev:A

STATUS: **Released**

Printed: Oct 30, 2004