



**Features**

- Frequency Range 2000MHz to 2800MHz
- Full Internal Matching and No External Bias Inductors
- 6-Bit Digital Step Attenuator
- SPI Serial Control Programming
- Max Gain = 41dB@2.6GHz
- Gain Control Range = 31.5dB (0.5dB Step Size)
- High OIP3/P1dB = +41dBm/28dBm
- Single +5V Supply
- Small 28-Pin, 6.0mmx6.0mm, MCM
- Power-up Programming

**Applications**

- Cellular, 3G Infrastructure
- WiBro, WiMax, LTE
- Microwave Radio
- High-linearity Power Control

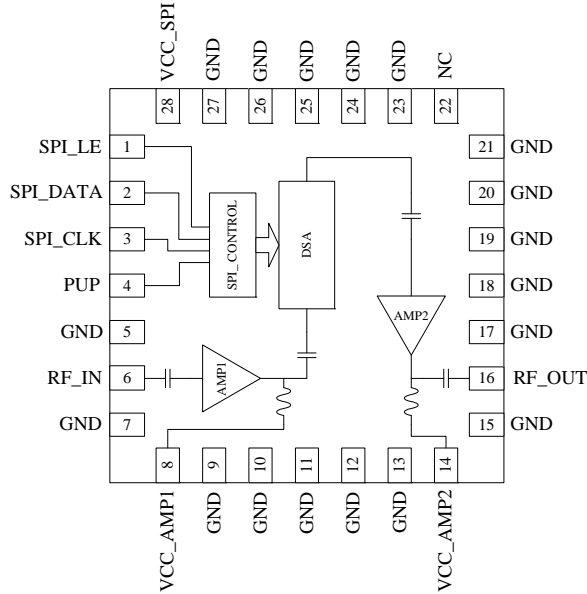

Functional Block Diagram

**Product Description**

RFMD's RFDA2046 is a digital controlled variable gain amplifier featuring high linearity over the entire gain control range with noise figure less than 5.2dB in its maximum gain state. The gain of the 6-bit digital step attenuator is programmed with a serial mode control interface (SPI). The RFDA2046 is packaged in a small 6.0mmx6.0mm leadless laminate MCM, which contains plated through thermal vias for ultra-low thermal resistance. This module is easy to use with no external matching components required.

**Ordering Information**

RFDA2046TR13	13" Reel with 2500 pieces
RFDA2046TR7	7" Reel with 750 pieces
RFDA2046SR	7" Sample reel with 100 pieces
RFDA2046SB	Sample bag of 5 pieces
RFDA2046PCK-410	2000MHz to 2800MHz PCBA with 5 pieces

**Optimum Technology Matching® Applied**

- |   |                                      |  |                                    |
|---|--------------------------------------|--|------------------------------------|
| <input checked="" type="checkbox"/> GaAs HBT  | <input type="checkbox"/> SiGe BiCMOS | <input checked="" type="checkbox"/> GaAs pHEMT | <input type="checkbox"/> GaN HEMT  |
| <input type="checkbox"/> GaAs MESFET          | <input type="checkbox"/> Si BiCMOS   | <input checked="" type="checkbox"/> Si CMOS    | <input type="checkbox"/> BiFET HBT |
| <input checked="" type="checkbox"/> InGaP HBT | <input type="checkbox"/> SiGe HBT    | <input type="checkbox"/> Si BJT                | <input type="checkbox"/> LDMSO     |

RF MICRO DEVICES®, RFMD®, Optimum Technology Matching®, Enabling Wireless Connectivity™, PowerStar®, POLARIS™ TOTAL RADIO™ and UltimateBlue™ are trademarks of RFMD, LLC. BLUETOOTH is a trademark owned by Bluetooth SIG, Inc., U.S.A. and licensed for use by RFMD. All other trade names, trademarks and registered trademarks are the property of their respective owners. ©2006, RF Micro Devices, Inc.

## Absolute Maximum Ratings

Parameter	Rating	Unit
Supply Voltage	+5.5	V <sub>DC</sub>
DC Supply Current	760	mA
Power Dissipation	3200	mW
Max RF Input Power for Long Term Operation (50Ω)	-5	dBm
Max RF Input Power for Short Term Operation (50Ω)	+20	dBm
Operating Temperature (T <sub>CASE</sub> )	-40 to +85	°C
Storage Temperature	-40 to +150	°C
Junction Temperature	+150	°C
ESD Rating (HBM)	500 (Class 1B)	V
Moisture Sensitivity Level	MSL3	



**Caution!** ESD sensitive device.

Exceeding any one or a combination of the Absolute Maximum Rating conditions may cause permanent damage to the device. Extended application of Absolute Maximum Rating conditions to the device may reduce device reliability. Specified typical performance or functional operation of the device under Absolute Maximum Rating conditions is not implied.

The information in this publication is believed to be accurate and reliable. However, no responsibility is assumed by RF Micro Devices, Inc. ("RFMD") for its use, nor for any infringement of patents, or other rights of third parties, resulting from its use. No license is granted by implication or otherwise under any patent or patent rights of RFMD. RFMD reserves the right to change component circuitry, recommended application circuitry and specifications at any time without prior notice.



RFMD Green: RoHS compliant per EU Directive 2002/95/EC, halogen free per IEC 61249-2-21, < 1000ppm each of antimony trioxide in polymeric materials and red phosphorus as a flame retardant, and <2% antimony in solder.

Parameter	Specification			Unit	Condition
	Min.	Typ.	Max.		
<b>Overall</b>					T=25 °C, V <sub>CC</sub> =V <sub>DD</sub> =5V, Standard Application Circuit, Measured at 2600MHz
Frequency Range	2000		2800	MHz	
Max Gain		41		dB	Attenuation=0dB
Gain Control Range		31.5		dB	
Step Accuracy	+/- (0.1+5% attenuation setting)			dB	Major state error up to 2800MHz
P1dB		28		dBm	Attenuation=0dB
Output IP3		41.0		dBm	P <sub>OUT</sub> =19dBm/tone, 1MHz spacing
Control Interface		6		bit	SPI interface
Settling Time		250		ns	t <sub>ON</sub> , t <sub>OFF</sub> (10%/90% RF)
Noise Figure		5.2		dB	Attenuation=0dB
Impedance		50		Ω	
Input Return Loss		15		dB	
Output Return Loss		12		dB	
Total Supply Voltage	4.75	5.0	5.25	V	
Supply Current		360		mA	From V <sub>CC_SPI</sub> , V <sub>CC_AMP1</sub> and V <sub>CC_AMP2</sub>
Thermal Resistance		27		°C/W	

## Typical RF Performance at Key Operating Frequencies

Parameter	Unit	2000MHz	2400MHz	2500MHz	2600MHz	2700MHz	2800MHz
Max Small Signal Gain	dB	40	40	40	41	41	41
Output P1dB	dBm	28	28	28	28	28	27.5
Output IP3 [1]	dBm	38	40	41	41	40	39
Input Return Loss	dB	14	15	15	15	15	15
Output Return Loss	dB	11	14	14	12	11	8
Noise Figure	dB	5.2	5.2	5.2	5.2	5.2	5.2

Note: [1]OIP3 is tested at P<sub>out</sub>=19dBm/Tone and 1MHz spacing

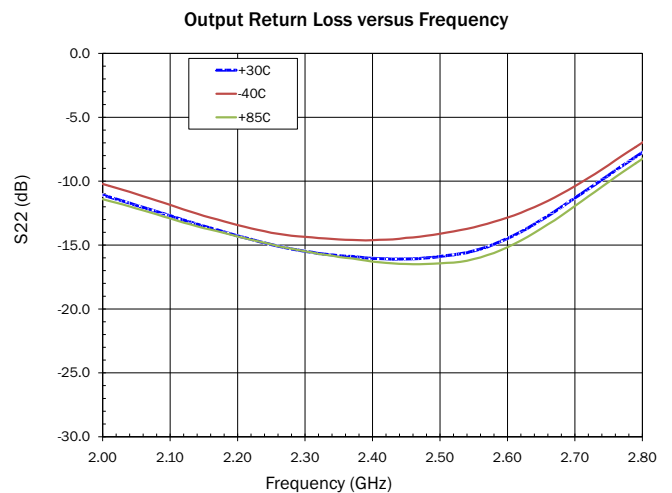
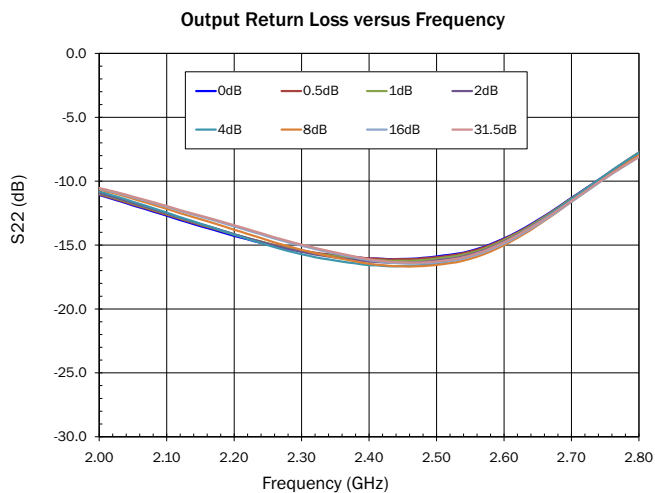
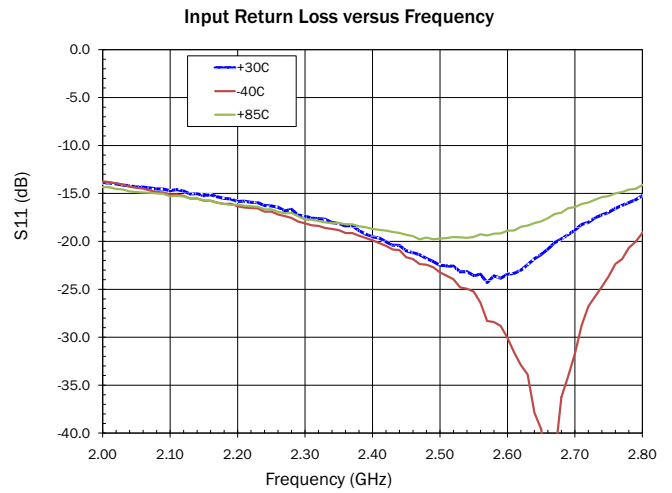
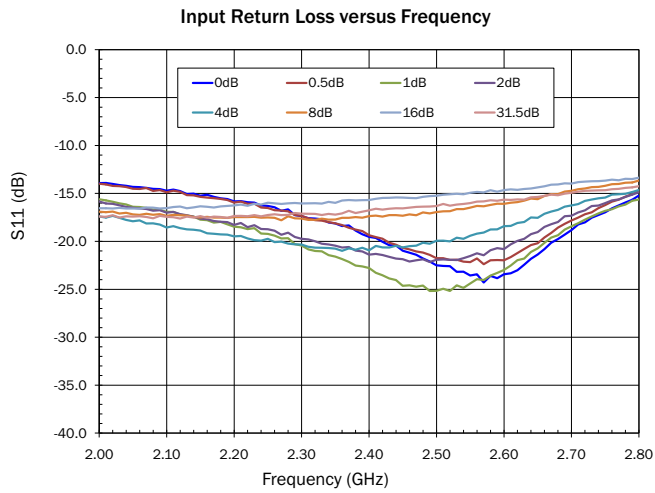
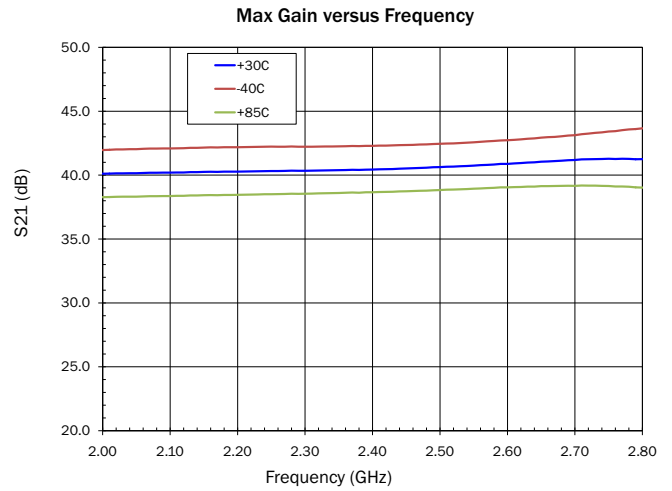
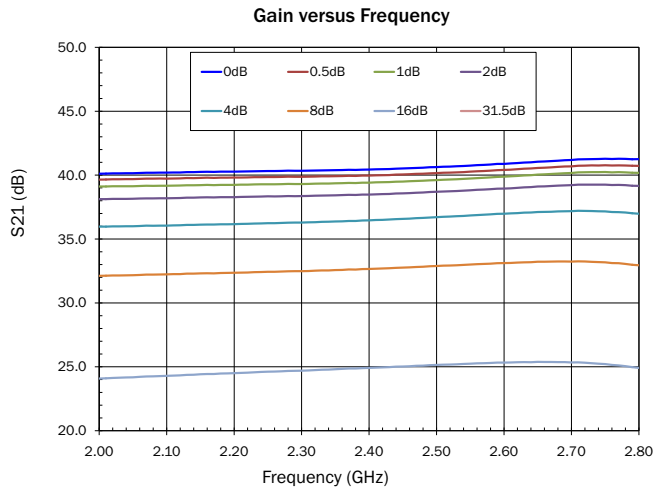

Isolation versus Frequency

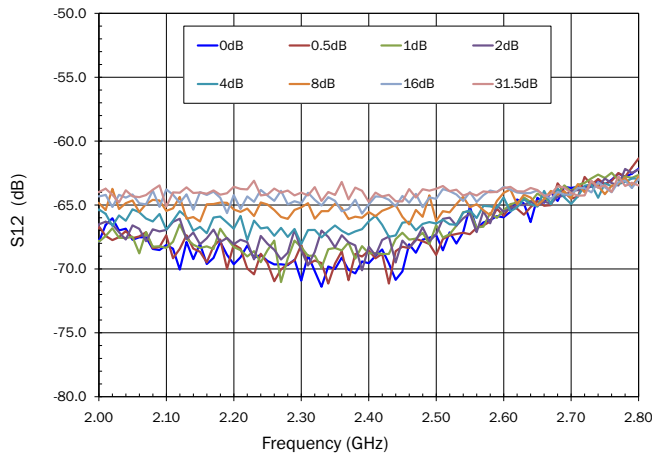

Isolation versus Frequency

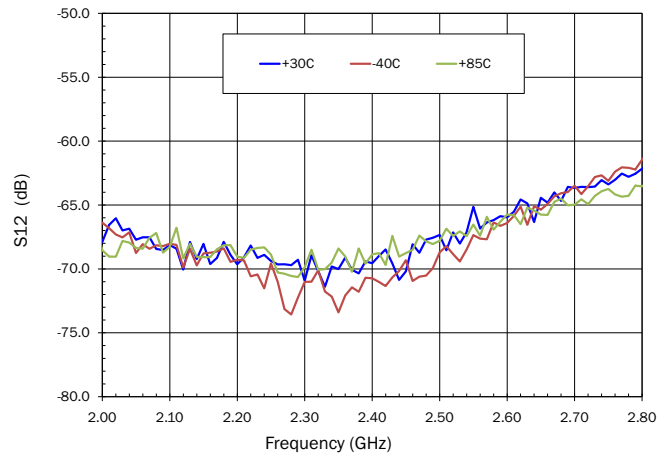

Normalized Phase Error versus Frequency

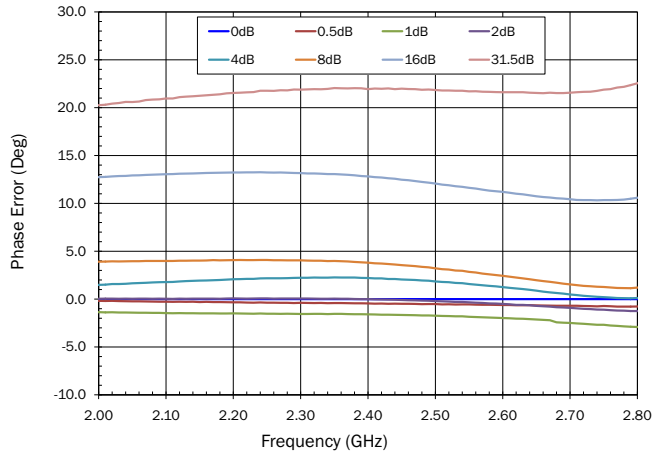

Successive Step Error versus Attenuation State

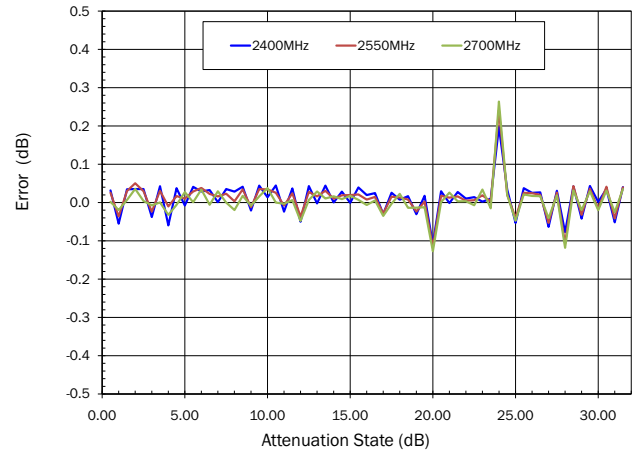

Bit Error versus Frequency

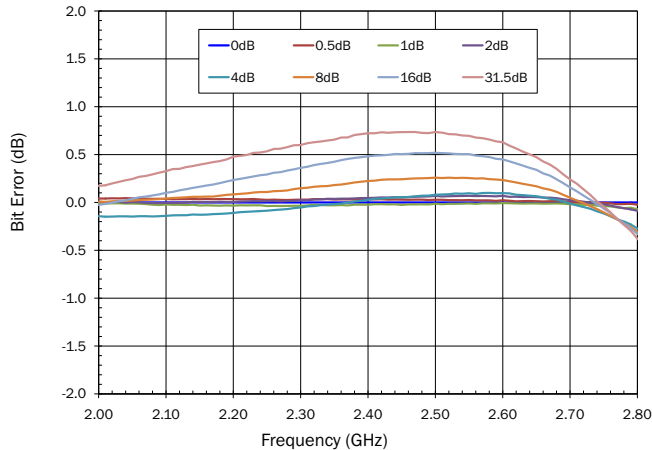

Bit Error versus Attenuation State

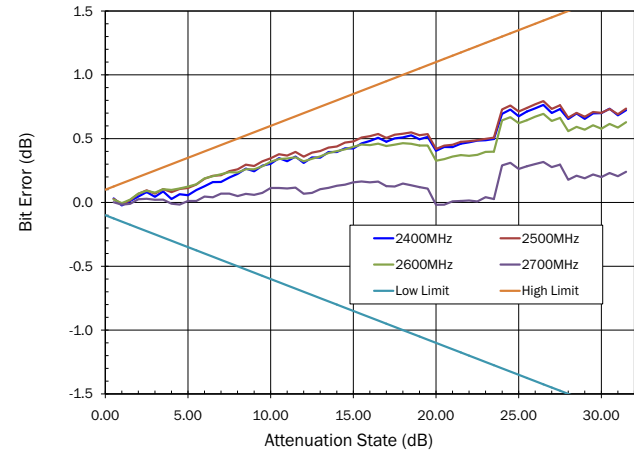

**Normalized Attenuation versus Frequency**

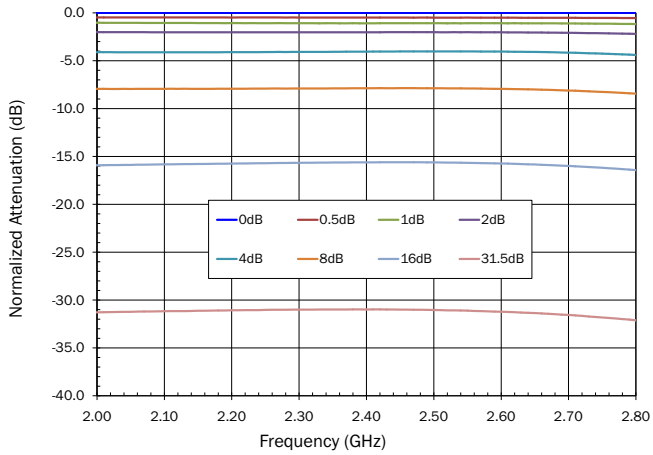

**Successive Step Error versus Attenuation State**

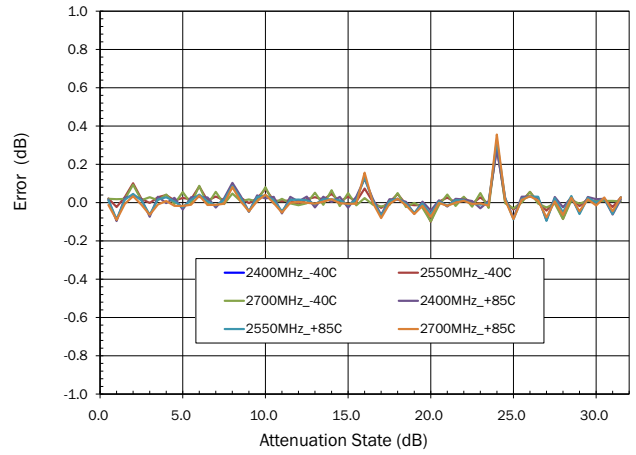

**Output P1dB versus Frequency**

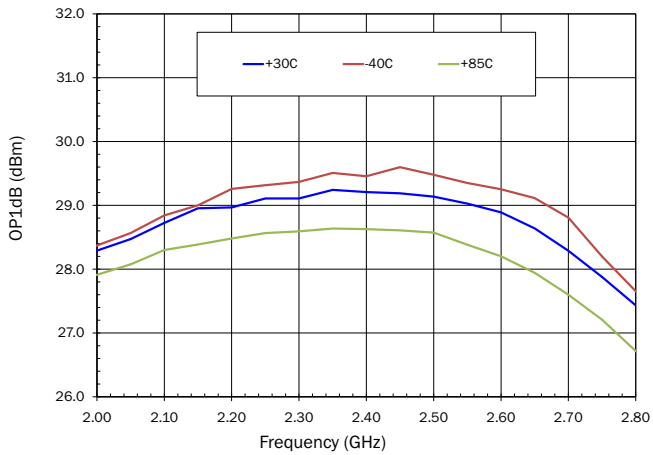

**Output IP3 versus Frequency**

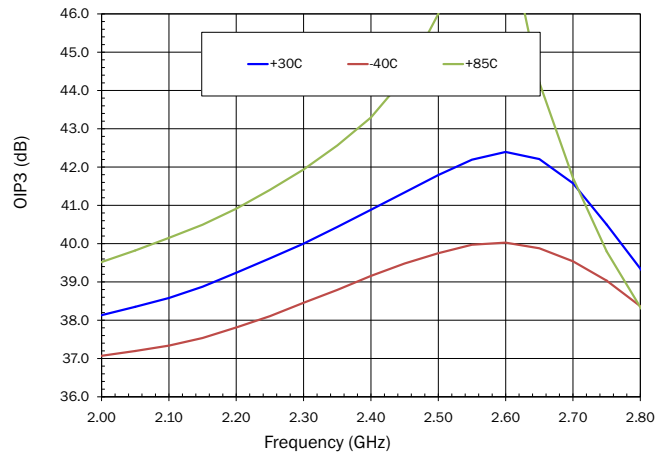

**Noise Figure versus Frequency**

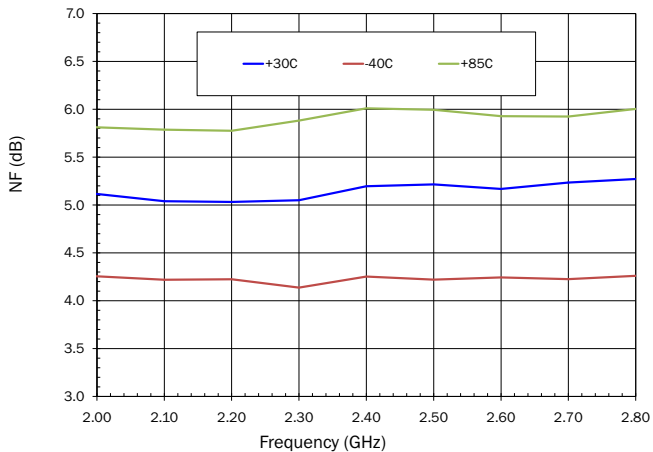

**Current versus Frequency**

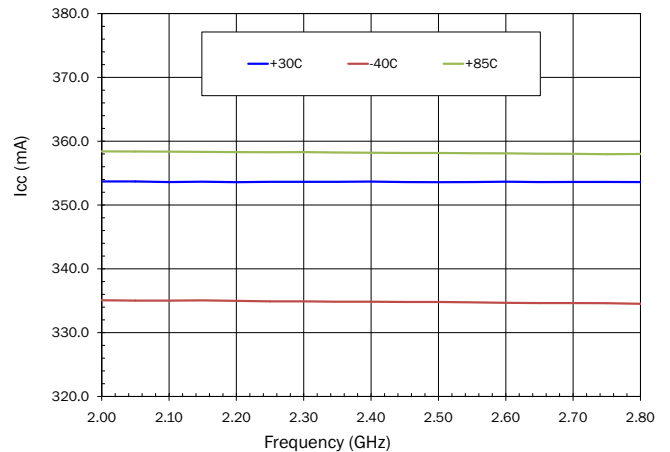

Truth Table

Control Bit						Gain Relative to Maximum Gain
D5	D4	D3	D2	D1	D0	
1	1	1	1	1	1	0dB
1	1	1	1	1	0	-0.5dB
1	1	1	1	0	1	-1dB
1	1	1	0	1	1	-2dB
1	1	0	1	1	1	-4dB
1	0	1	1	1	1	-8dB
0	1	1	1	1	1	-16dB
0	0	0	0	0	0	-31.5dB

## Serial Port Interface

### SPI Timing Diagram

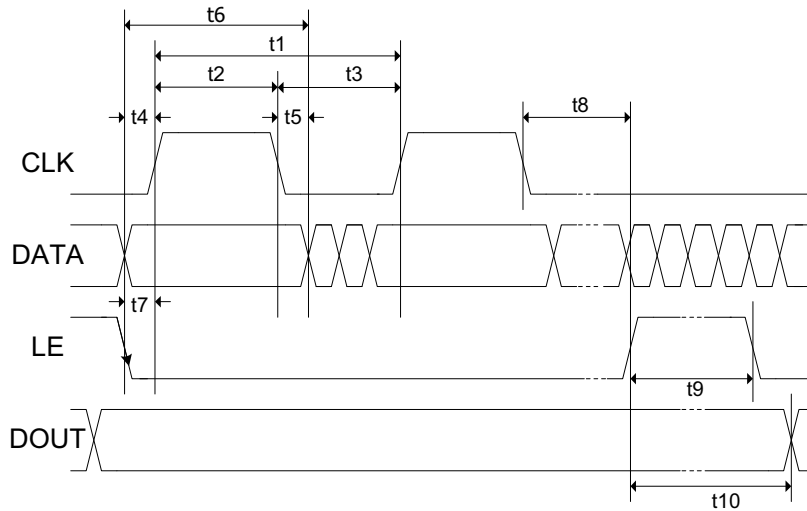

### Programming Example: 6-Bit

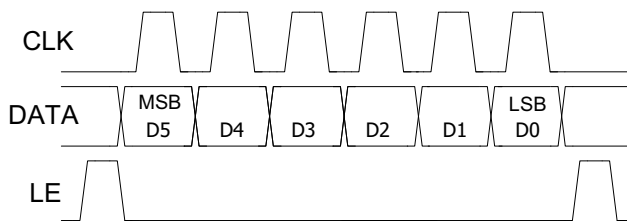

### SPI Timing Diagram Specifications

Parameter	Limit	Unit	Comment
t1	25	MHz max	CLK Frequency
t2	20	ns min	CLK High
t3	20	ns min	CLK Low
t4	5	ns min	DATA to CLK Setup Time
t5	5	ns min	DATA to CLK Hold Time
t6	30	ns min	DATA Valid
t7	5	ns min	LE to CLK Setup Time
t8	5	ns min	CLK to LE Setup Time
t9	10	ns min	LE Pulse Width
t10	20	ns max	Output Set

Power-up Programming Truth Table	
PUP	Attenuator Setting
Low	Attenuation at max, 31.5dB
High	Attenuation at min, 0dB

Logic Voltage Levels	
State	Logic
Low	0V to 0.8V
High	2.0V to 5.0V

## Pin Names and Description

Pin	Function	Description
1	SPI_LE	Serial Latch Enable Input
2	SPI_DATA	Serial Data Input
3	SPI_CLK	Serial Clock Input
4	PUP	Power-up Programming Pin
5	GND	RF/DC Ground Connection
6	RF_IN	RF Input
7	GND	RF/DC Ground Connection
8	VCC_AMP1	Supply Voltage for Amplifier 1
9	GND	RF/DC Ground Connection
10	GND	RF/DC Ground Connection
11	GND	RF/DC Ground Connection
12	GND	RF/DC Ground Connection
13	GND	RF/DC Ground Connection
14	VCC_AMP2	Supply Voltage for Amplifier 2
15	GND	RF/DC Ground Connection
16	RF_OUT	RF Output
17	GND	RF/DC Ground Connection
18	GND	RF/DC Ground Connection
19	GND	RF/DC Ground Connection
20	GND	RF/DC Ground Connection
21	GND	RF/DC Ground Connection
22	NC	Do Not Connect, Leave Open Circuit
23	GND	RF/DC Ground Connection
24	GND	RF/DC Ground Connection
25	GND	RF/DC Ground Connection
26	GND	RF/DC Ground Connection
27	GND	RF/DC Ground Connection
28	VCC_SPI	Supply Voltage for SPI and DSA Chip



**Package Drawing**  
6.0mmx6.0mm Laminate Module

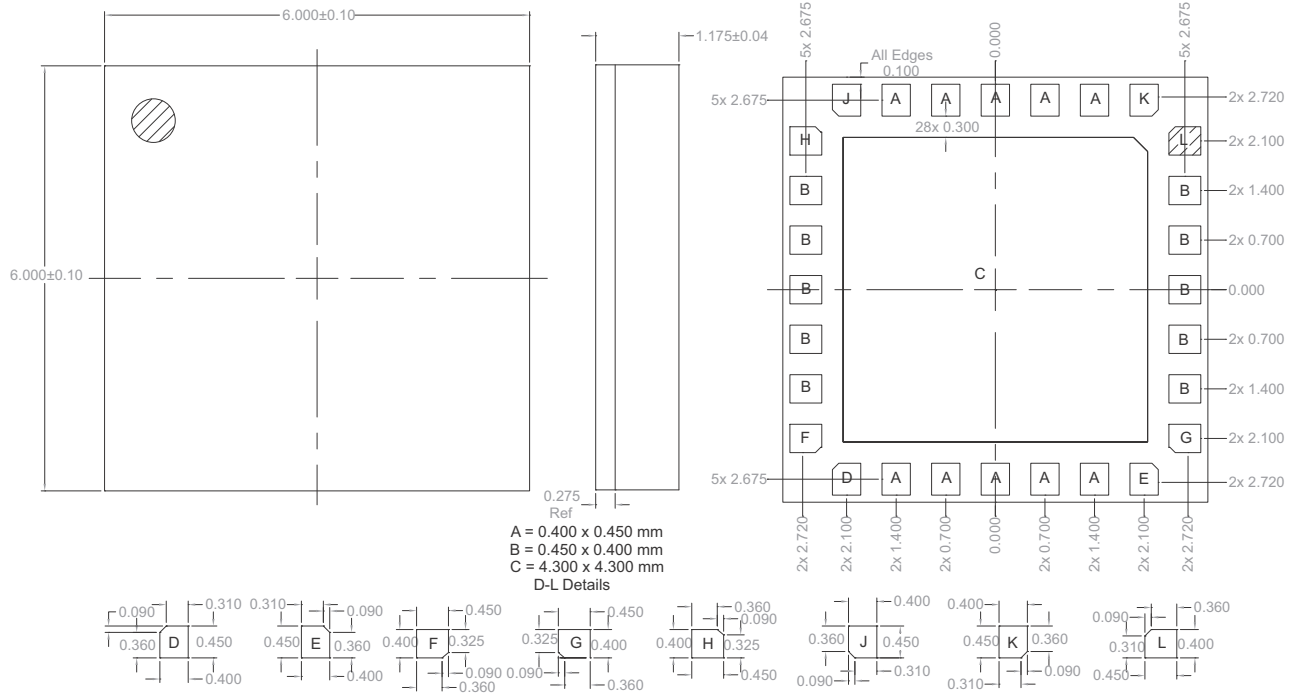

Notes:  
1. Shaded area represents Pin 1 location

**Evaluation Board Assembly Drawing**

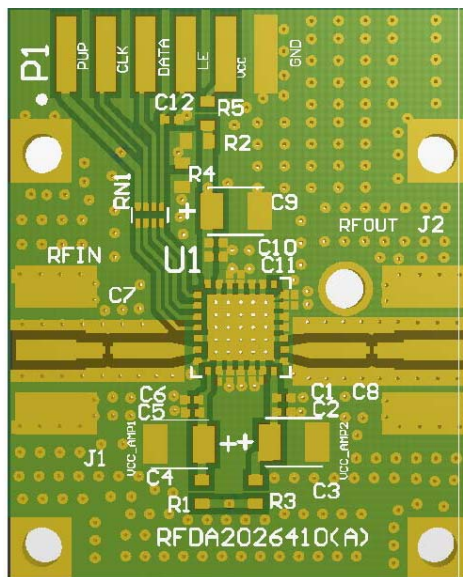

### Branding Diagram

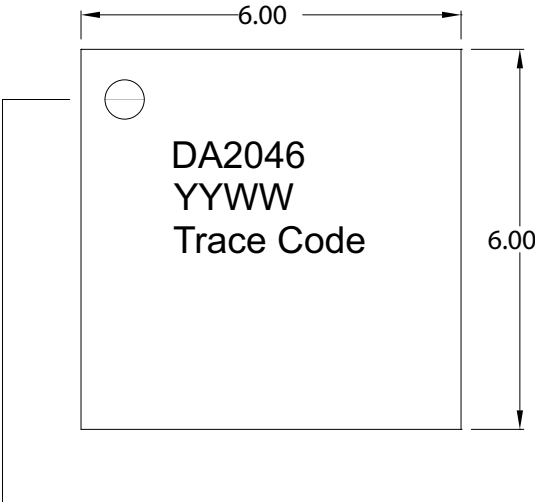

Pin 1 Indicator

Fill in the YYWW Notation with the Date Code

YY = Year

WW = Week

Trace Code to be assigned by SubCon

## Evaluation Board Schematic

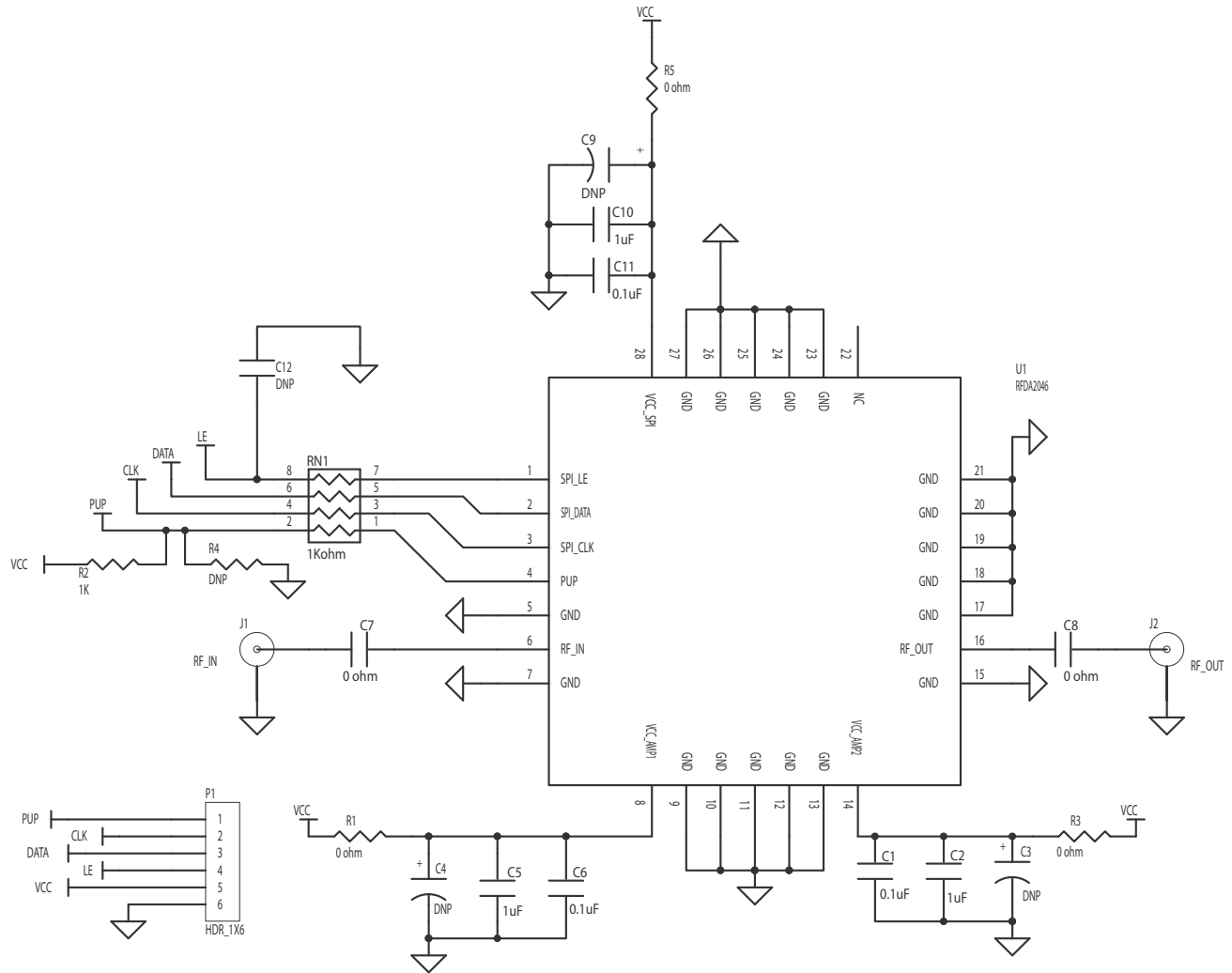

## Evaluation Board Bill of Materials

Description	Reference Designator	Manufacturer	Manufacturer's P/N
CAP, 0.1uF, 10%, 10V, X7R, 0402	C1, C6, C11	Murata Electronics	GRM155R71C104KA88D
CAP, 1uF, 10%, 10V, X7R, 0402	C2, C5, C10	Murata Electronics	GRM155R61A105KE15D
RES, 0 Ω, 0402	C7, C8	Kamaya, Inc	RMC1/16SJPTH
RES, 1K, 5%, 1/16, 0603	R2	Panasonic Industrial Co	ERJ-3GEYJ102
RES ARRAY, 4-ELEM, 1K, 5%, SMD 4x0402	RN1	KOA	CN1E4KTTD102J
RES, 0Ω, 0603	R1, R3, R5	Kamaya, Inc	RMC1/16JPTP
Not Placed	C3, C4, C9, C12		
CONN, HDR, ST, PLRZD, 6-PIN, 0.100"	P1	ITW Pancon	MPSS100-6-C
RFDA2026 PCB	PCB	RFMD	267192
RFDA2046	U1	RFMD	RFDA2046
CONN, SMA, END LNCH, FLT, 0.062"	J1, J2	Emerson Network Power	142-0701-821