

## GM2123

### CMOS Positive Voltage Regulator

#### Description

The GM2123 series of positive, linear regulators feature low quiescent current (30 $\mu$ A typ.) with low dropout voltage, making them ideal for battery applications. These rugged devices have both Thermal Shutdown, and Current Fold-back to prevent device failure under the "Worst" of operating conditions. The GM2123 is stable with an output capacitance of 2.2 $\mu$ F or greater.

#### Features

- Very Low Dropout Voltage
- Guaranteed 300mA output
- Over-Temperature Shutdown
- Current Limiting
- Short Circuit Current Fold-back
- Factory Pre-set Output Voltage
- Highly Accurate $\pm$  1.5%
- Low Temperature Coefficient

#### Applications

- Battery Powered Widgets
- Instrumentation
- Wireless Devices
- Cordless Phones
- PC Peripherals
- Portable Electronics
- Electronic Scales

#### Package Dimensions

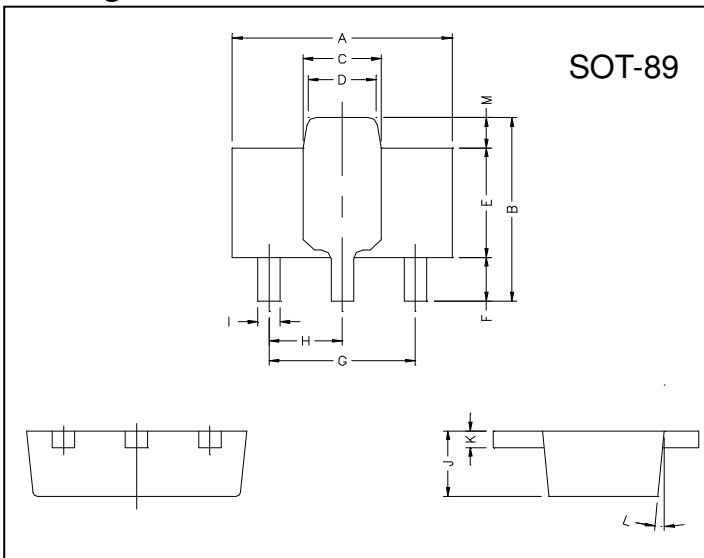

#### Block Diagram

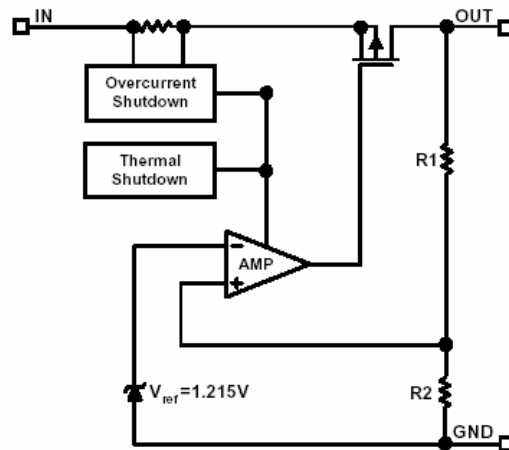

#### Marking :

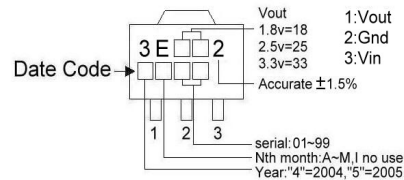

REF.	Millimeter		REF.	Millimeter	
	Min.	Max.		Min.	Max.
A	4.4	4.6	G	3.00	REF.
B	4.05	4.25	H	1.50	REF.
C	1.50	1.70	I	0.40	0.52
D	1.30	1.50	J	1.40	1.60
E	2.40	2.60	K	0.35	0.41
F	0.89	1.20	L	5°	TYP.
			M	0.70	REF.

#### Typical Application Circuit

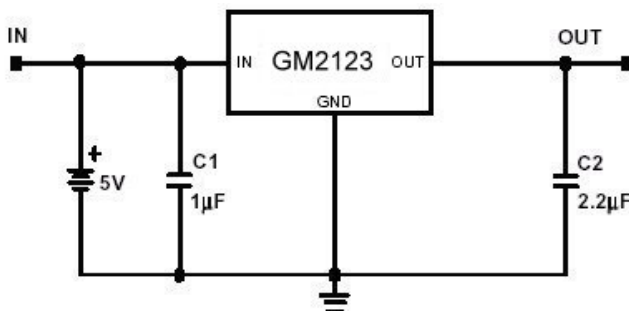

**Absolute Maximum Ratings**

Parameter	Symbol	Ratings	Unit
Input Voltage	V <sub>IN</sub>	8	V
Output Current	I <sub>OUT</sub>	PD/(V <sub>IN</sub> -V <sub>O</sub> )	mA
Output Voltage	V <sub>OUT</sub>	1.3~5	V
Operating Ambient Temperature	T <sub>opr</sub>	-40 ~ +85	°C
Junction Temperature	T <sub>j</sub>	-40 ~ +125	°C
Maximum Junction Temperature	T <sub>j Max</sub>	150	°C
Thermal Resistance	θ <sub>jc</sub>	38	°C/W
	θ <sub>ja</sub>	180	°C/W
Power Dissipation(ΔT=100°C)	PD	550	mW
EDS Classification		B	

**Electrical Characteristics Ta=25°C**

Parameter	Symbol	Condition	Min	TYP	Max	Unit	
Output Voltage	V <sub>OUT(E)</sub> (Note1)	V <sub>IN</sub> =V <sub>OUT(T)</sub> +1V, I <sub>O</sub> =1mA	-1.5%	V <sub>OUT(T)</sub> (Note2)	1.5%	V	
Output Current	I <sub>O</sub>	V <sub>IN</sub> =V <sub>OUT(T)</sub> +2V, V <sub>OUT</sub> ≥V <sub>OUT(E)</sub> *0.96	300	-	-	mA	
Current Limit	I <sub>LIM</sub>	V <sub>O</sub> >1.2V	300	450	-	mA	
Load Regulation	REG <sub>LOAD</sub>	V <sub>IN</sub> =V <sub>OUT(T)</sub> +2V, I <sub>O</sub> =1mA to 300mA	-1	0.2	1	%	
Dropout Voltage	V <sub>DROPOUT</sub>	I <sub>O</sub> =300mA V <sub>O</sub> =V <sub>OUT(E)</sub> -2%	1.3V≤V <sub>OUT(T)</sub> ≤2.0V	-	-	1300	mV
		2.0V<V <sub>OUT(T)</sub> ≤2.8V	-	-	400		
		2.8V<V <sub>OUT(T)</sub>	-	-	300		
Quiescent Current	I <sub>Q</sub>	V <sub>IN</sub> =V <sub>OUT(T)</sub> +1V	-	30	50	μA	
Line Regulation	REG <sub>LINE</sub>	I <sub>O</sub> =1mA V <sub>IN</sub> =V <sub>OUT(T)</sub> +1 to V <sub>OUT(T)</sub> +2	1.3V≤V <sub>OUT(T)</sub> ≤1.4V	-0.2	-	0.2	%
			1.4V<V <sub>OUT(T)</sub> ≤2.0V	-0.15	-	0.15	
			2.0V<V <sub>OUT(T)</sub> <4.0V	-0.1	0.02	0.1	
			4.0V≤V <sub>OUT(T)</sub>	-0.4	0.2	0.4	
Input Voltage	V <sub>IN</sub>		Note3	-	7	V	
Over Temperature Shutdown	OTS		-	150	-	°C	
Over Temperature Hysteresis	OTH		-	30	-	°C	
Output Voltage Temperature Coefficient	TC		-	30	-	ppm/°C	
Short Circuit Current(Note4)	I <sub>SC</sub>	V <sub>IN</sub> =V <sub>OUT(T)</sub> +1V V <sub>OUT</sub> =0V	-	150	300	mA	
Power Supply Rejection	PSRR	I <sub>O</sub> =100mA C <sub>O</sub> =2.2μF	f=1kHz	-	50	-	dB
			f=10kHz	-	20	-	
			f=100kHz	-	15	-	
Output Voltage Noise	e <sub>N</sub>	f=10Hz~100kHz I <sub>O</sub> =10mA				μVrms	

Note 1: V<sub>OUT(E)</sub> =Effective Output Voltage (i.e. the output voltage when "V<sub>OUT(T)</sub> +1.0V" is provided at the V<sub>IN</sub> pin while maintaining a certain I<sub>OUT</sub> value).

2: V<sub>OUT(T)</sub> =Specified Output Voltage

3: V<sub>IN(MIN)</sub> =V<sub>OUT</sub>+V<sub>DROPOUT</sub>

4: To prevent the Short Circuit Current protection feature from being prematurely activated, the input voltage must be applied before a current source load is applied.

## Ordering Information ( contd.)

Part Number	Marking	Output Voltage	Part Number	Marking	Output Voltage
GM2123-13	3E132 XXXX	1.3V	GM2123-15	3E152 XXXX	1.5V
GM2123-18	3E182 XXXX	1.8V	GM2123-19	3E192 XXXX	1.9V
GM2123-20	3E202 XXXX	2.0V	GM2123-25	3E252 XXXX	2.5V
GM2123-27	3E272 XXXX	2.7V	GM2123-28	3E282 XXXX	2.8V
GM2123-29	3E292 XXXX	2.9V	GM2123-30	3E302 XXXX	3.0V
GM2123-31	3E312 XXXX	3.1V	GM2123-33	3E332 XXXX	3.3V
GM2123-34	3E342 XXXX	3.4V	GM2123-35	3E352 XXXX	3.5V
GM2123-36	3E362 XXXX	3.6V	GM2123-37	3E372 XXXX	3.7V
GM2123-38	3E382 XXXX	3.8V	GM2123-50	3E502 XXXX	5.0V

## Characteristics Curve

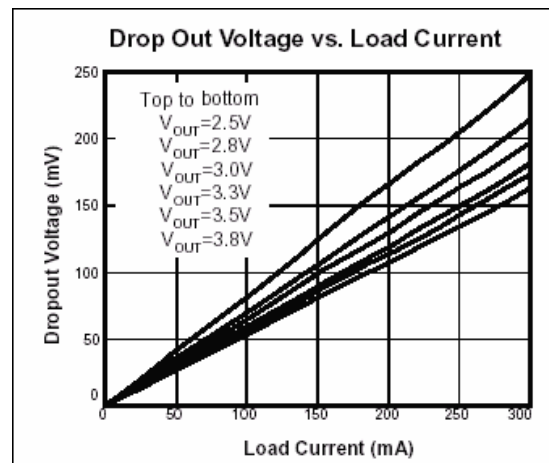
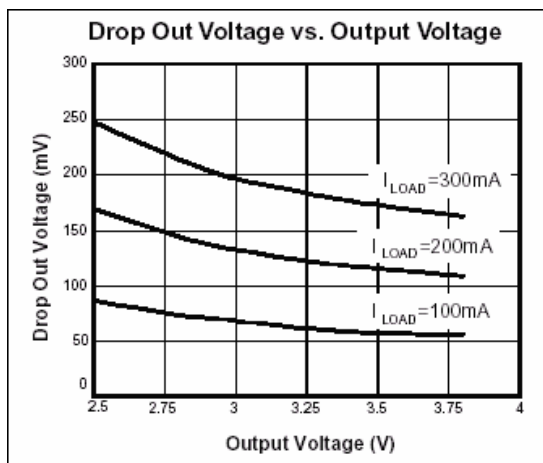
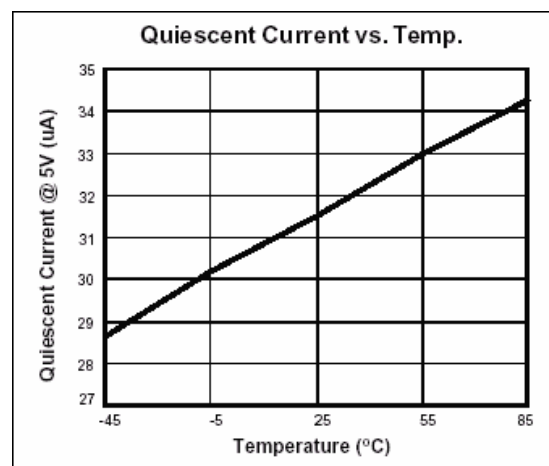
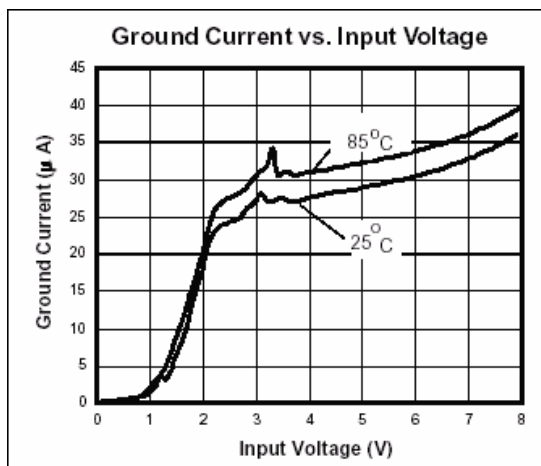

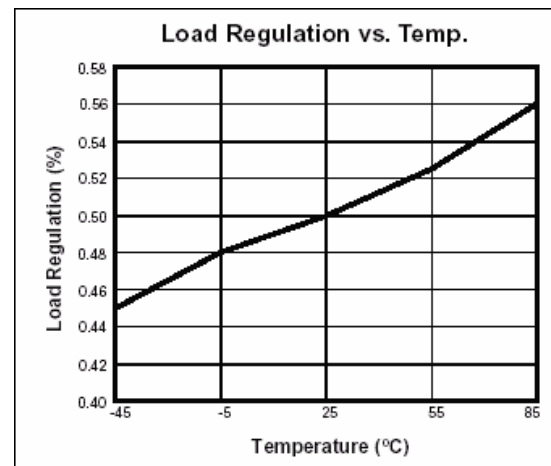
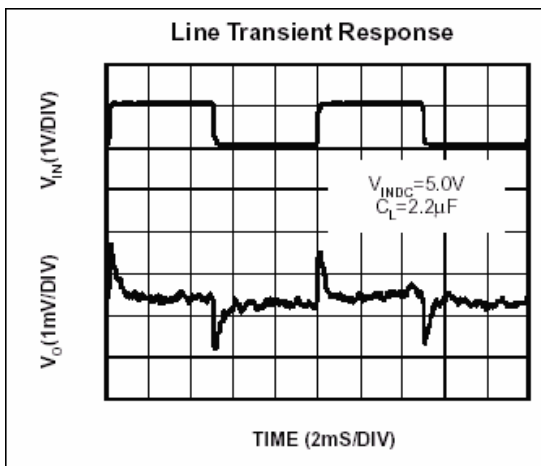
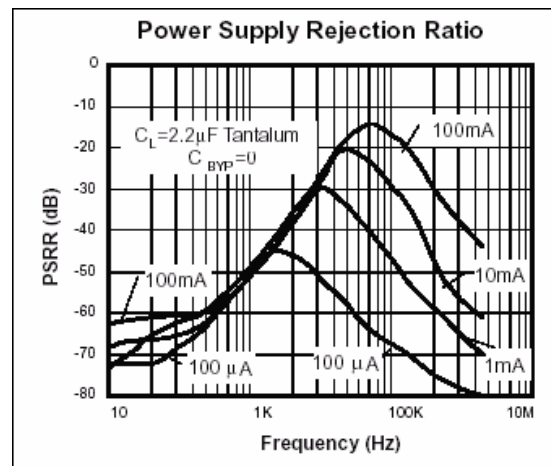
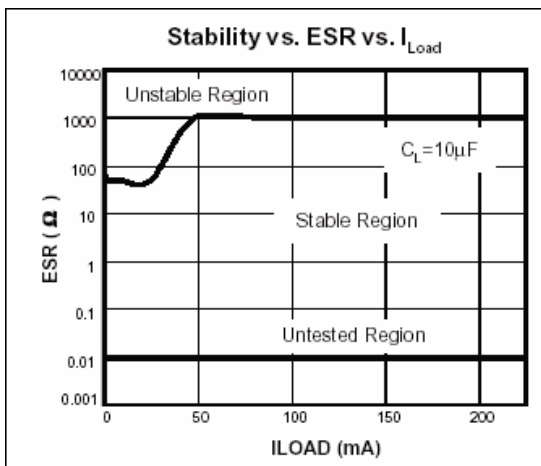
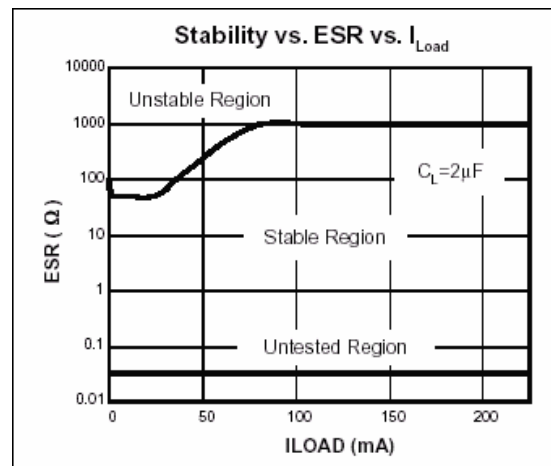
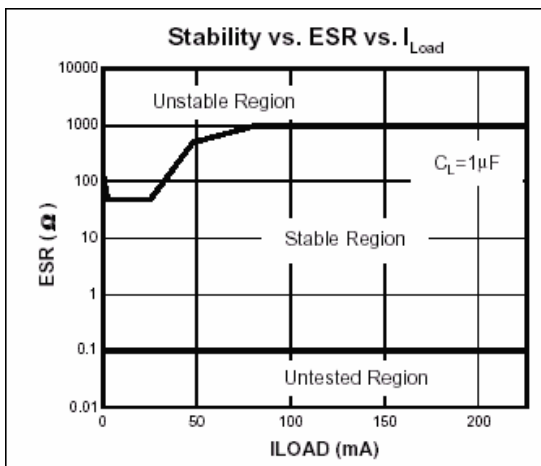

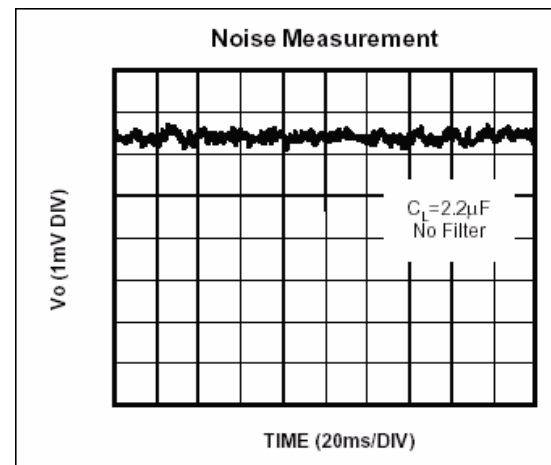
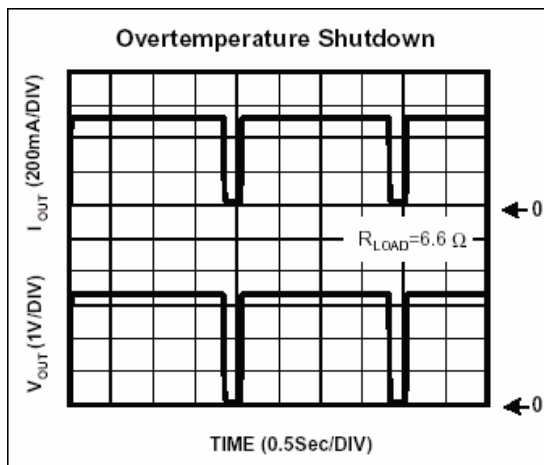
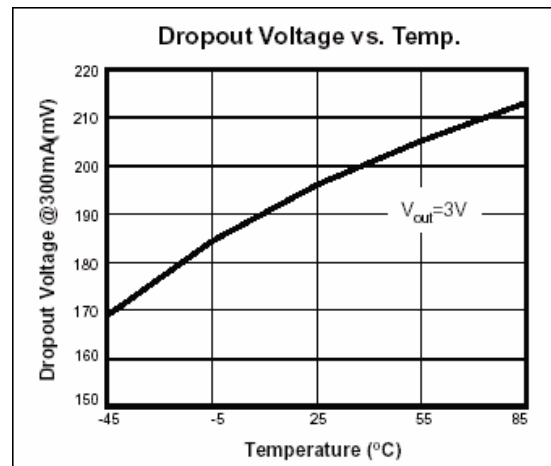
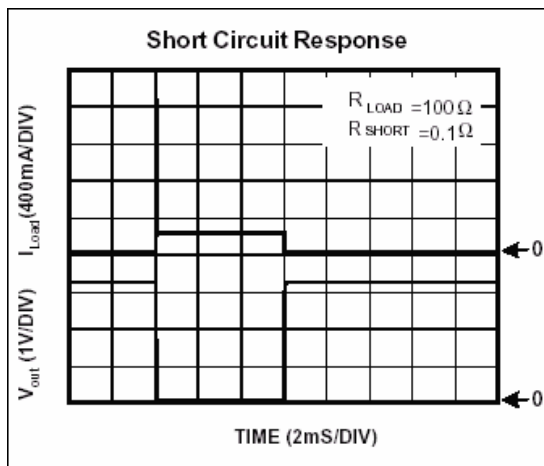
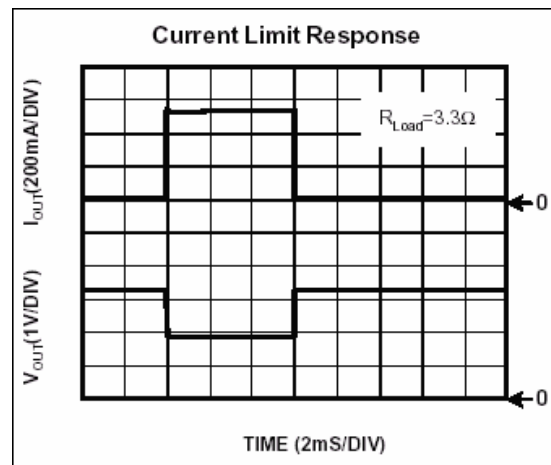
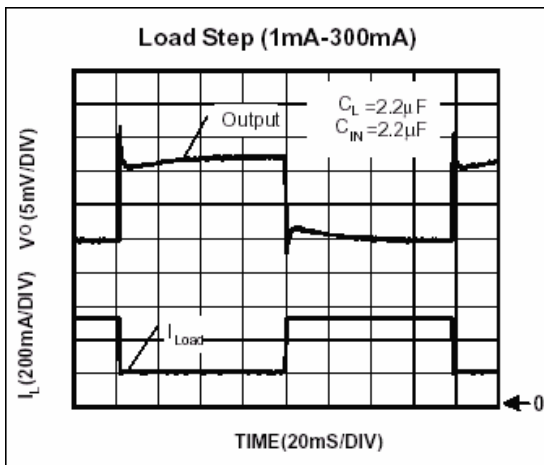

**Important Notice:**

- All rights are reserved. Reproduction in whole or in part is prohibited without the prior written approval of GTM.
- GTM reserves the right to make changes to its products without notice.
- GTM semiconductor products are not warranted to be suitable for use in life-support Applications, or systems.
- GTM assumes no liability for any consequence of customer product design, infringement of patents, or application assistance.

**Head Office And Factory:**

- Taiwan: No. 17-1 Tatung Rd. Fu Kou Hsin-Chu Industrial Park, Hsin-Chu, Taiwan, R. O. C.
- TEL : 886-3-597-7061 FAX : 886-3-597-9220, 597-0785
- China: (201203) No.255, Jang-Jiang Tsai-Lueng RD. , Pu-Dung-Hsin District, Shang-Hai City, China
- TEL : 86-21-5895-7671 ~ 4 FAX : 86-21-38950165