



## Description

Fast Delivery Time

SXXXX Series are micro capacitance SIDACtor Protection Thyristor designed to protect telecommunications equipment such as ADSL Modems,Router, , Telephone, CCTV Camera,Digital Video Record,Video Capture Card,Twisted-pair video transmitter,CATV Splitter.....Etc.

SXXXX Series SIDACtor Protection Thyristor are used to enable equipment to meet various regulatory requirements including GR 1089, ITU K.20/21,IEC 61000-4-5, YD/T 1082,YD/T 993,YD/T 950,TIA-968-A ,TIA-968-B



## Features

Compared to surge suppression using other technologies, SXXXX Series devices offer absolute surge protection regardless of the surge current available and the rate of applied voltage (dv/dt). SXXXX Series devices:

- 100% Lead-Free(RoHs Compliant )
- Cannot be damaged by voltage
- Eliminate hysteresis and heat dissipation typically found with clamping devices
- Eliminate voltage overshoot caused by fast-rising transients
- Are non-degenerative
- Have low capacitance, making them ideal for high-speed transmission equipment

## Electrical Characteristics

Parameter	Definition
$V_{DRM}$	<b>Peak Off-state Voltage</b> — maximum voltage that can be applied while maintaining off state
$V_S$	<b>Switching Voltage</b> — maximum voltage prior to switching to on state
$I_H$	<b>Holding Current</b> — minimum current required to maintain on state
$I_S$	<b>Switching Current</b> — maximum current required to switch to on state
$I_T$	<b>On-state Current</b> — maximum rated continuous on-state current
$V_T$	<b>On-state Voltage</b> — maximum voltage measured at rated on-state current
Capacitance	<b>Off-state Capacitance</b> — typical capacitance measured in off state
$I_{DRM}$	<b>Leakage Current</b> — maximum peak off-state current measured at $V_{DRM}$
$I_{PP}$	<b>Peak Pulse Current</b> — maximum rated peak impulse current
$I_{TSM}$	<b>Peak One-cycle Surge Current</b> — maximum rated one-cycle AC current
di/dt	<b>Rate of Rise of Current</b> — maximum rated value of the acceptable rate of rise in current over time

## Electrical Characteristics



Part Number	$V_{DRM}$ @ $I_{DRM}=5 \mu A$	$V_S$ @ $100V/\mu s$	$I_H$	$I_S$	$I_T$	$V_T$ @ $I_T=2.2Amps$	Capacitance @ $1MHz, 2V$ bias
	$V_{min}$	$V_{max}$	$mA_{min}$	$mA_{max}$	$A_{max}$	$V_{max}$	pF
S008A	6	25	50	800	2.2	4	30
S23A	190	260	150	800	2.2	4	35
S26A	220	300	150	800	2.2	4	35
S31A	275	350	150	800	2.2	4	30
S35A	320	400	150	800	2.2	4	30

Notes:

-All measurements are made at an ambient temperature of 25°C .Ipp applies to -40°C through +85°C temperature range .

-Off-state capacitance(Co) is typical value.

\*For surge ratings,see next page.

## Surge Ratings



Series	$I_{pp}$ 2x10 $\mu$ s	$I_{pp}$ 8x20 $\mu$ s	$I_{pp}$ 10x160 $\mu$ s	$I_{pp}$ 10x560 $\mu$ s	$I_{pp}$ 10x1000 $\mu$ s	$I_{pp}$ 5x320 $\mu$ s	$I_{pp}$ 5x310 $\mu$ s	$I_{pp}$ 10x360 $\mu$ s	$I_{TSM}$ 50/60Hz	di/dt
	Amps	Amps	Amps	Amps	Amps	Amps	Amps	Amps	Amps	Amps/ $\mu$ s
A	150	150	90	50	45	75	75	75	20	500

## Thermal Considerations

Package	DO-214AC/SMA	Symbol	Parameter	Value	Unit
		$T_J$	Operating Junction Temperature Range	-40 to +150	$^{\circ}$ C
		$T_S$	Storage Temperature Range	-65 to +150	$^{\circ}$ C
		$R_{\theta JA}$	Junction to Ambient on prited circuit	90	$^{\circ}$ C /W

## Description of Part Number

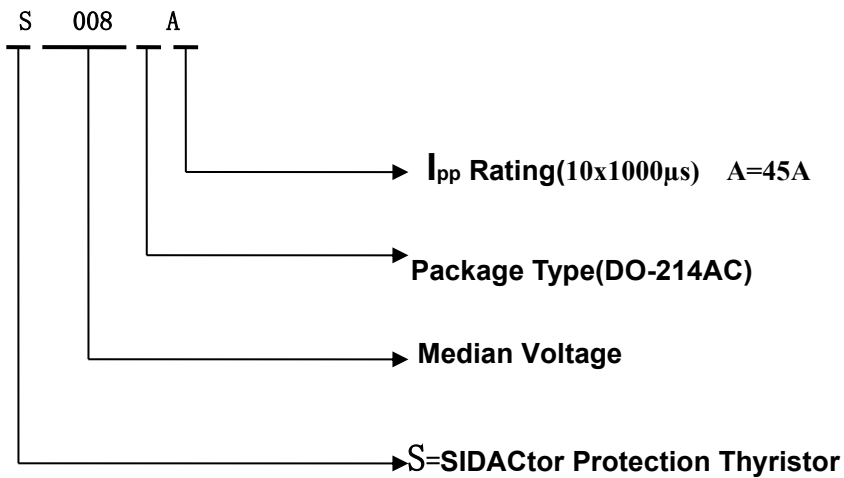

Dimensions - DO-214AC

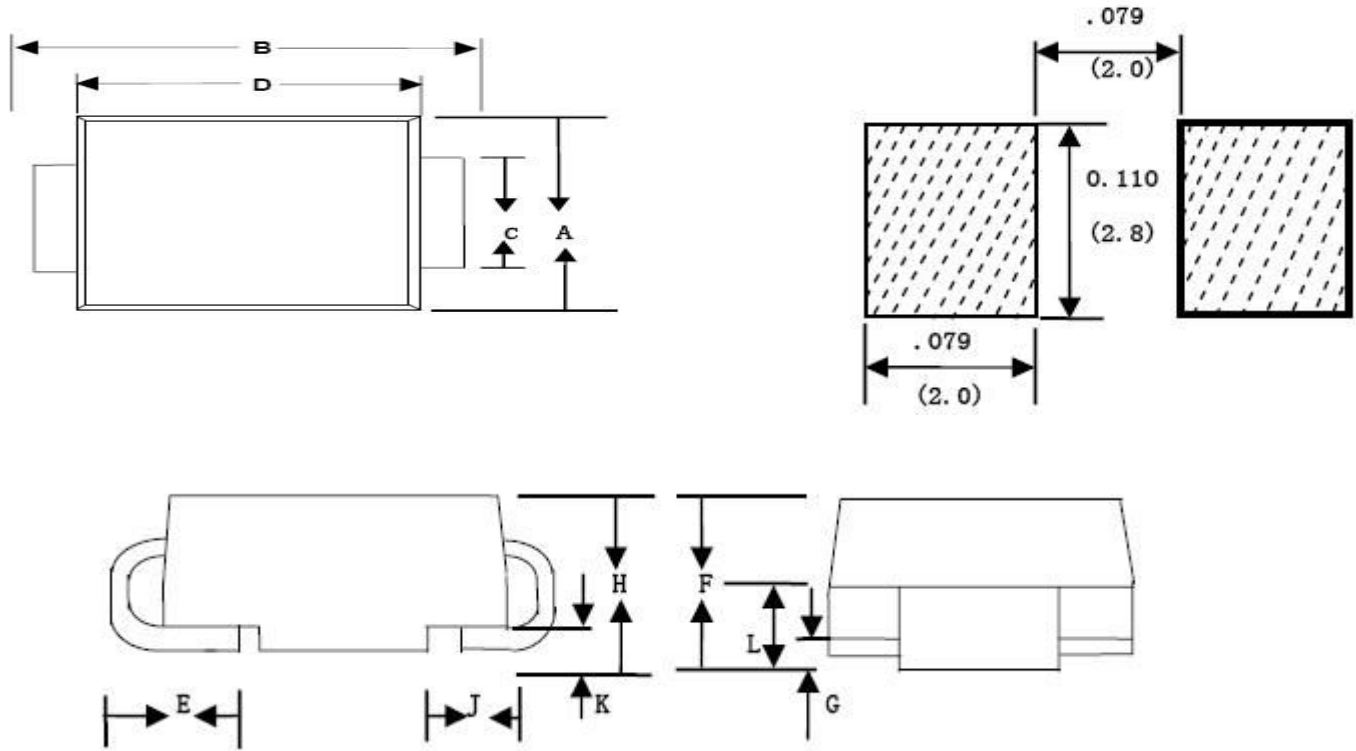

Dimension	Inches		Millimeters	
	Min	Max	Min	Max
A	0.098	0.114	2.50	2.90
B	0.188	0.208	4.80	5.28
C	0.055	0.062	1.40	1.60
D	0.157	0.181	4.00	4.60
E	0.030	0.060	0.76	1.52
F	0.078	0.096	2.00	2.44
H	0.080	0.104	2.05	2.64

## Packing Options



Package Type	Description	Packing Quantity	Industry Standard
A	DO-214AC Reel Pack	5000 PCS	EIA-481-D

## Characteristics Curve

### V-I Characteristics

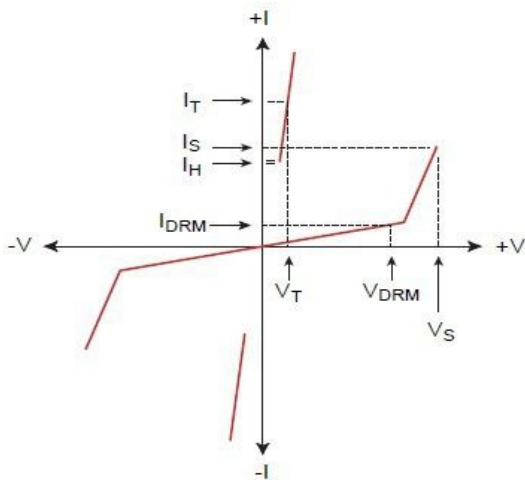

### Tr x Td Pulse Waveform

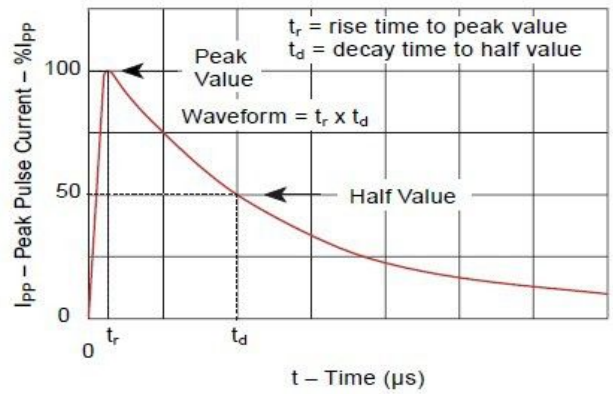

### Normalized Vs Change Versus Junction Temperature

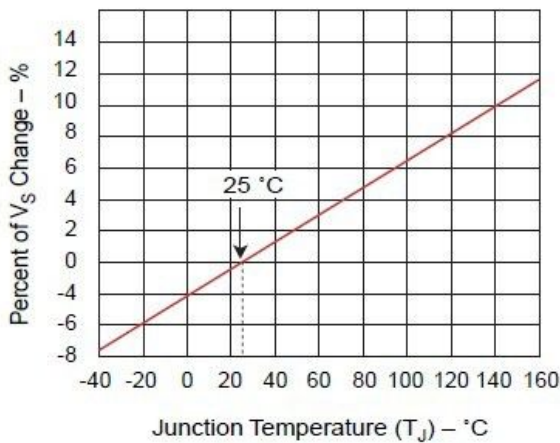

### Normalized DC Holding Current Versus Case Temperature

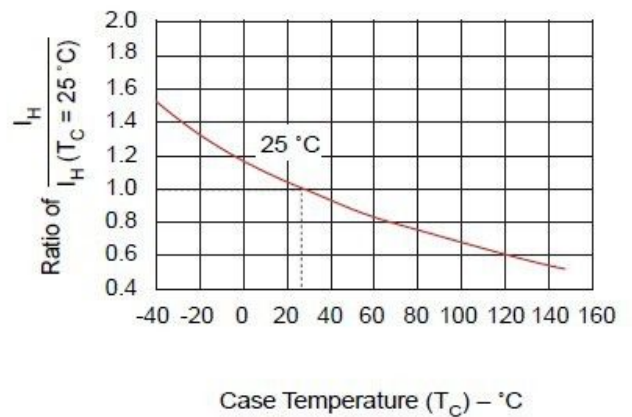

Sample pictures

S008A

**Fast Delivery Time**

