

SPECIFICATIONS

PARAMETERS	VALUES	UNITS
RATED VOLTAGE	3.6	Vp-p
OPERATING VOLTAGE RANGE	2.5 ~ 4.5	Vp-p
RATED CURRENT (MAX)	90	mA
COIL RESISTANCE	15 ± 3	OHM
MINIMUM SPL @ 10 CM	87	dB
RESONANT FREQUENCY	2,500 ± 500	Hz
OPERATING TEMPERATURE	-30 ~ +70	°C
STORAGE TEMPERATURE	-40 ~ +85	°C
HOUSING MATERIAL	LCP	-
TERMINAL MATERIAL	Sn PLATED PBS	-
WEIGHT	0.42	grams

THIS DOCUMENT CONTAINS DATA PROPRIETARY TO PROJECTS UNLIMITED, INC. ANY USE OR REPRODUCTION, IN ANY FORM, WITHOUT PRIOR WRITTEN PERMISSION OF PROJECTS UNLIMITED, INC. IS PROHIBITED.
©2003, Projects Unlimited Inc.

REVISION HISTORY

LTR	DESCRIPTION	DATE	APPROVED
-	RELEASED FROM ENGINEERING	1/4/2005	
A	CHANGED MATERIAL & TERMINAL MATERIAL	3/9/2005	G.V.
B	REMOVED LEAD FREE ADDED RoHS NOTE	8/10/2005	
C	ADDED RESONANT FREQ. TOLERANCE	5/16/2007	R.W.
D	REVISED TO INVENTOR 3-D DRAWING TEMPLATE	5/3/2010	B.R.

A (5 : 1)

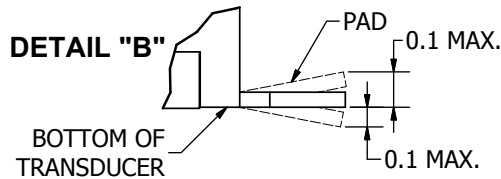
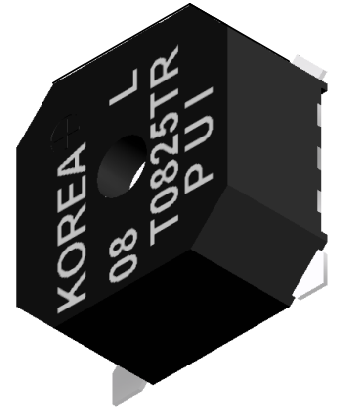
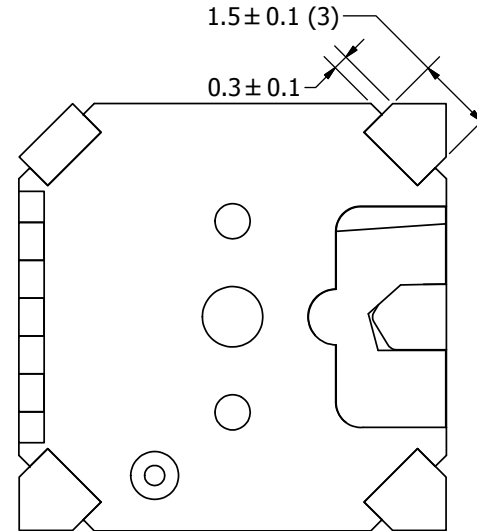
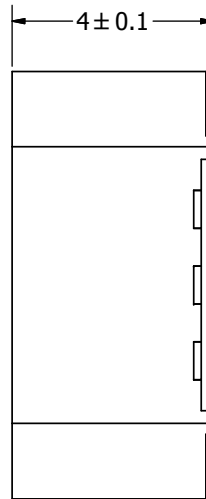
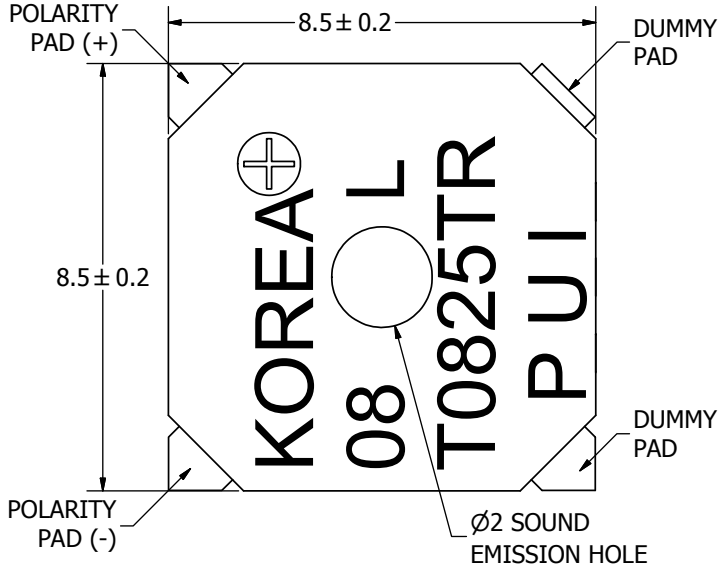
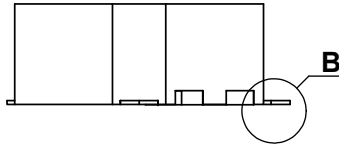

NOTES:

1. ALL DIMENSIONS ARE IN MILLIMETERS.
2. SPECIFICATIONS SUBJECT TO CHANGE OR WITHDRAWAL WITHOUT NOTICE.
3. THIS PART IS RoHS 2002/95/EC COMPLIANT.

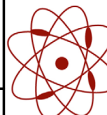
UNLESS OTHERWISE SPECIFIED: DIMENSIONS ARE IN MILLIMETERS, TOLERANCES ARE ±0.5 AND ANGLES ARE ±3°.	SIZE A3	Designed by	Date	Checked by	Date	Approved by	Date	Drawn Date
		R.A.C.	1/4/2005			R.W.	1/4/2005	5/3/2010
SMT-0825-T-R.idw		 pui audio a projects unlimited company			SMT-0825-T-R			
		Transducer (Electro-Mech)				Edition	Sheet	
						-	1 / 1	