



# TJA1085

FlexRay active star coupler

Rev. 1 — 23 October 2012

Product data sheet

## 1. General description

---

The TJA1085 is a FlexRay active star coupler that can connect up to 4 branches of a FlexRay network. The TJA1085 is compliant with the FlexRay electrical physical layer specification V3.0.1 (see [Ref. 1](#)).

Several TJA1085 devices can be connected via their TRXD0/1 interfaces to increase the number of branches in the network. A dedicated Communication Controller (CC) interface allows for integration into an ECU. The TJA1085 supports low-power management by offering bus wake-up capability along with battery supply and voltage regulator control. The TJA1085 meets industry standards for EMC/ESD performance and provides enhanced bus error detection, low current consumption and unmatched asymmetric delay performance.

The TJA1085 also fulfills the JASPAR requirements as defined by the Japanese car industry.

## 2. Features and benefits

---

### 2.1 General

- Compliant with FlexRay Electrical Physical Layer specification V3.0.1.
- Fulfills JASPAR requirements
- Automotive product qualification in accordance with AEC-Q100
- Data transfer rates from 2.5 Mbit/s to 10 Mbit/s
- Supports 60 ns minimum bit time at 400 mV differential voltage
- Low-power management for battery-supplied ECUs
- Very low current consumption in AS\_Sleep mode
- Leadless HVQFN44 package with improved Automated Optical Inspection (AOI) capability

### 2.2 Functional

- Supports autonomous active star operation independent of the host ensuring the TJA1085 remains active even if the host fails or is switched off
- Branches can be independently configured
- Branch extension via TRXD0/1 inner star interface
- 16-bit bidirectional SPI interface up to 2 Mbit/s for host communication
- Full host control over branch status
- Enhanced wake-up capability:
  - ◆ Remote wake-up via wake-up pattern and dedicated FlexRay data frames



- ◆ Local wake-up via pin LWU
- ◆ Wake-up source recognition
- ◆ configurable per branch
- Enhanced supply voltage monitoring on  $V_{IO}$ ,  $V_{CC}$ ,  $V_{BUF}$  and  $V_{BAT}$
- Auto I/O level adaptation to host controller supply voltage  $V_{IO}$
- Can be used in 14 V, 24 V and 48 V powered systems
- Enhanced bus error detection - detects short-circuit conditions on the bus
- Instant transmitter shut-down interface (BGE pin)
- Selective branch shut-down (partial networking)

### 2.3 Robustness

- Bus pins protected against  $\pm 8$  kV ESD pulses according to HBM and  $\pm 6$  kV ESD pulses according to IEC61000-4-2
- All pins protected against  $\pm 1000$  V ESD according to CDM
- All pins protected against  $\pm 200$  V ESD according to MM
- No reverse currents from the digital input pins to  $V_{IO}$  or  $V_{CC}$  when the TJA1085 is not powered up
- Bus pins short-circuit proof to battery voltage (14 V, 24 V or 48 V) and ground
- Overtemperature detection and protection
- Bus pins protected against transients in automotive environment (according to ISO 7637 class C)

### 2.4 Active star functional classes

- Active star - communication controller interface
- Active star - bus guardian interface
- Active star - voltage regulator control
- Active star - logic level adaptation
- Active star - host interface
- Active star - increased voltage amplitude transmitter

## 3. Ordering information

Table 1. Ordering information

Type number	Package		Version
	Name	Description	
TJA1085HN	HVQFN44	plastic thermal enhanced very thin quad flat package; no leads; 44 terminals; body $9 \times 9 \times 0.85$ mm	SOT1113-1

### 4. Block diagram

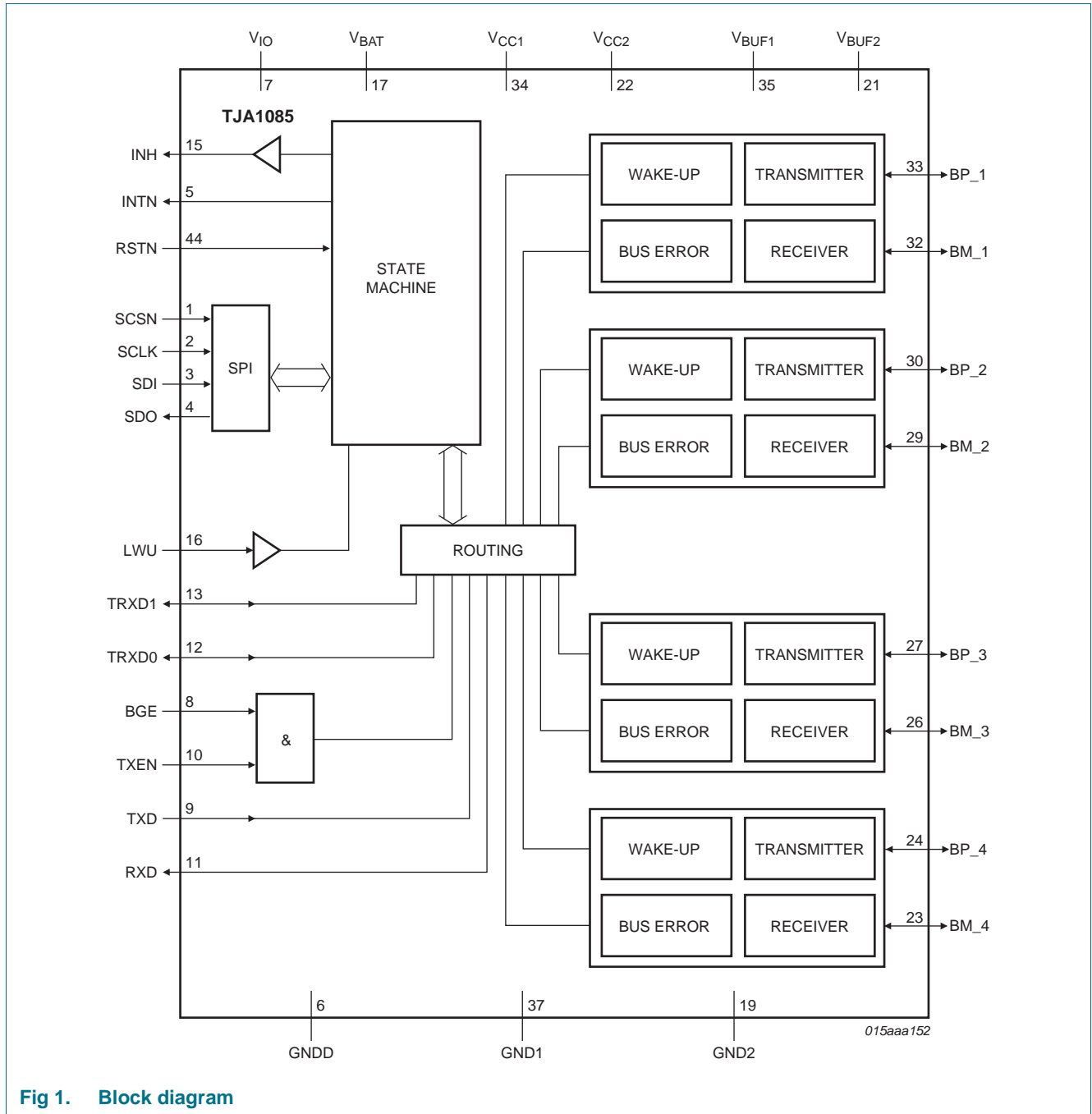
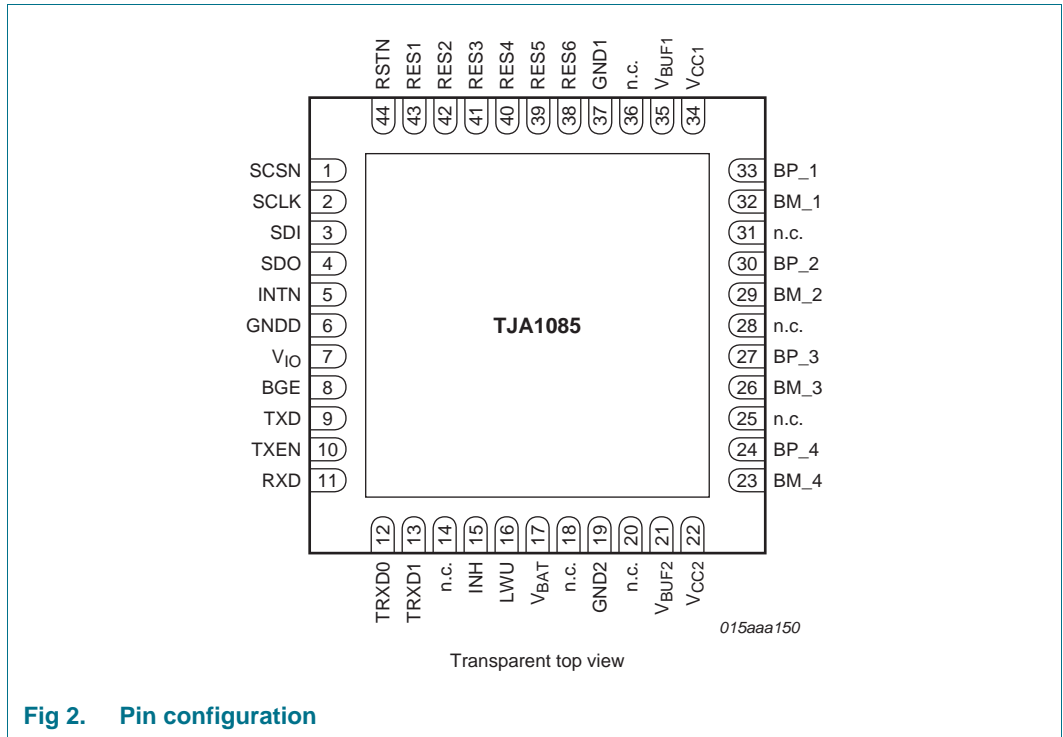

Fig 1. Block diagram

## 5. Pinning information

### 5.1 Pinning



### 5.2 Pin description

Table 2. Pin description

Symbol	Pin	Type <sup>[1]</sup>	Description
SCSN	1	I	SPI chip select input; internal pull-up
SCLK	2	I	SPI clock signal; internal pull-down
SDI	3	I	SPI data input; internal pull-down
SDO	4	O	SPI data output; 3-state output
INTN	5	O	interrupt output; open-drain output, low-side driver
GNDD	6	G	ground for digital circuits <sup>[2]</sup>
V <sub>IO</sub>	7	P	supply voltage for V <sub>IO</sub> voltage level adaptation
BGE	8	I	bus guardian enable input; internal pull-down
TXD	9	I	transmit data input; internal pull-down
TXEN	10	I	transmitter enable input; internal pull-up
RXD	11	O	receive data output
TRXD0	12	IO	data bus line 0 for inner star connection
TRXD1	13	IO	data bus line 1 for inner star connection
n.c.	14	-	not connected; to be connected to GND in application
INH	15	O	inhibit output; for switching external voltage regulator

Table 2. Pin description ...continued

Symbol	Pin	Type <sup>[1]</sup>	Description
LWU	16	I	local wake-up input; internal pull-up or pull-down (depends on voltage at pin LWU)
V <sub>BAT</sub>	17	P	battery supply voltage
n.c.	18	-	not connected; to be connected to GND in application
GND2	19	G	ground connection for branches 3 and 4 <sup>[2]</sup>
n.c.	20	-	not connected; to be connected to GND in application
V <sub>BUF2</sub>	21	P	buffer supply voltage for branches 3 and 4 <sup>[3]</sup>
V <sub>CC2</sub>	22	P	supply voltage for branches 3 and 4 <sup>[4]</sup>
BM_4	23	IO	bus line minus for branch 4 <sup>[5]</sup>
BP_4	24	IO	bus line plus for branch 4 <sup>[6]</sup>
n.c.	25	-	not connected; to be connected to GND in application
BM_3	26	IO	bus line minus for branch 3 <sup>[5]</sup>
BP_3	27	IO	bus line plus for branch 3 <sup>[6]</sup>
n.c.	28	-	not connected; to be connected to GND in application
BM_2	29	IO	bus line minus for branch 2 <sup>[5]</sup>
BP_2	30	IO	bus line plus for branch 2 <sup>[6]</sup>
n.c.	31	-	not connected; to be connected to GND in application
BM_1	32	IO	bus line minus for branch 1 <sup>[5]</sup>
BP_1	33	IO	bus line plus for branch 1 <sup>[6]</sup>
V <sub>CC1</sub>	34	P	supply voltage for branches 1 and 2 <sup>[4]</sup>
V <sub>BUF1</sub>	35	P	buffer supply voltage for branches 1 and 2 <sup>[3]</sup>
n.c.	36	-	not connected; to be connected to GND in application
GND1	37	G	ground connection for branches 1 and 2 <sup>[2]</sup>
RES6	38	-	reserved; to be connected to GND in application
RES5	39	-	reserved; to be connected to GND in application
RES4	40	-	reserved; to be connected to GND in application
RES3	41	-	reserved; to be connected to GND in application
RES2	42	-	reserved; to be connected to GND in application
RES1	43	-	reserved; to be connected to GND in application
RSTN	44	I	reset input; internal pull-up

[1] IO: input/output; O: output; I: input; P: power supply; G: ground.

[2] GND1, GND2, GNDD and the exposed center pad of HVQFN44 package must be connected together on the PCB; references in the data sheet to GND can be assumed to encompass GND1, GND2, GNDD and the exposed center pad of HVQFN4 unless stated otherwise.

[3] V<sub>BUF1</sub> and V<sub>BUF2</sub> must be connected together on the PCB; note that references in the data sheet to V<sub>BUF</sub> can be assumed to encompass V<sub>BUF1</sub> and V<sub>BUF2</sub> unless stated otherwise.

[4] V<sub>CC1</sub> and V<sub>CC2</sub> must be connected together on the PCB; note that references in the data sheet to V<sub>CC</sub> can be assumed to encompass V<sub>CC1</sub> and V<sub>CC2</sub> unless stated otherwise.

[5] References in the data sheet to BM (e.g. pin BM or V<sub>BM</sub>) can be assumed to encompass BM\_1, BM\_2, BM\_3 and BM\_4 unless stated otherwise.

[6] References in the data sheet to BP (e.g. pin BP or V<sub>BP</sub>) can be assumed to encompass BP\_1, BP\_2, BP\_3 and BP\_4 unless stated otherwise.

## 6. Functional description

### 6.1 Supply voltage

The TJA1085 state machine is adequately supplied if at least one of  $V_{BAT}$ ,  $V_{CC}$  or  $V_{BUF}$  is available. The internal supply voltage to the state machine is denoted by  $V_{DIG}$ .  $V_{BUF}$  is an auxiliary supply and is only needed for forwarding the wake-up pattern when  $V_{CC}$  is not available.

### 6.2 Host Control (HC) and Autonomous Power (AP) modes - APM flag

The APM flag determines whether the TJA1085 is host-controlled or is operating in Autonomous Power mode. It is in AP mode by default.

The TJA1085 sets the APM flag:

- at power-on
- when a wake-up event is detected (on TRXD0/1, local or remote)
- when a  $V_{CC}$  undervoltage event is detected in AS\_Normal mode
- when a  $V_{IO}$  undervoltage event lasts longer than  $t_{to(uvd)}(V_{IO})$

The host can set or reset the APM flag at any time.

### 6.3 Signal router

The signal router transfers data received on an input channel to all channels configured as outputs. If data is being received on more than one input channel at the same time, the channel that was first to signal activity is selected and data on the other channel/s is ignored. Whether or not the data on an output channel is transmitted depends on whether the output channel is enabled or disabled.

The TJA1085 contains the following data input channels:

- Branches 1 to 4
- TRXD0/1 interface (inner star interface)
- TXD/TXEN interface

The TJA1085 contains the following data output channels:

- Branches 1 to 4
- TRXD0/1 interface
- RXD pin

#### 6.3.1 TRXD collision

When the TRXD0/1 interface is configured as an output channel, a TRXD collision is detected ( $COLL\_TRXD = 1$ ) if pins TRXD0 and TRXD1 are both LOW for longer than  $t_{det(col)}(TRXD)$ , generating a CLAMP\_ERROR interrupt.

When a TRXD collision is detected, the TJA1085 transmits a DATA\_0 to all other active output channels (irrespective of the actual data on the selected input channel), until the selected input channel detects idle state.

## 6.4 Wake-up

The TJA1085 supports the following wake-up mechanisms:

- Remote wake-up via the bus (wake-up pattern or dedicated wake-up frame)
- Local wake-up via pin LWU
- Activity on the inner star interface (pins TRXD0 and TRXD1)

Any wake-up event will generate a WU interrupt. A remote wake-up on a branch will generate an EVENT\_BRx interrupt to indicate the branch where the wake-up pattern or dedicated data frame was detected.

The host can identify the wake-up source by polling the General Status register (WU\_TRXD = 1 for a TRXD0/1 wake-up; WU\_LOCAL = 1 for a local wake-up) and the Branch Status register (WU\_BRx = 1 for a remote wake-up).

### 6.4.1 Remote wake-up

When the TJA1085 is in AS\_Standby or AS\_Sleep, all branches are monitored for wake-up events. When a valid wake-up pattern or data frame is detected on a branch, the relevant WU\_BRx status bit is set and the wake-up pattern/data frame is forwarded to all other enabled branches.

A remote wake-up event occurring during an AS\_Normal-to-AS\_Standby or AS\_Normal-to-AS\_Sleep transition will also be detected, setting the relevant WU\_BRx status bit and generating WU and EVENT\_BRx interrupts.

#### 6.4.1.1 Bus wake-up via wake-up pattern

A wake-up pattern consists of at least two consecutive wake-up symbols. A wake-up symbol consists of a DATA\_0 phase lasting longer than  $t_{\text{det(wake)DATA}_0}$ , followed by an idle phase lasting longer than  $t_{\text{det(wake)idle}}$ , provided both wake-up symbols occur within a time span of  $t_{\text{det(wake)tot}}$  (see [Figure 3](#)). The transceiver also wakes up if the idle phases are replaced by DATA\_1 phases.

A wake-up event is not detected if an invalid wake-up pattern is received. See [Ref. 1](#) for more details on invalid wake-up patterns.

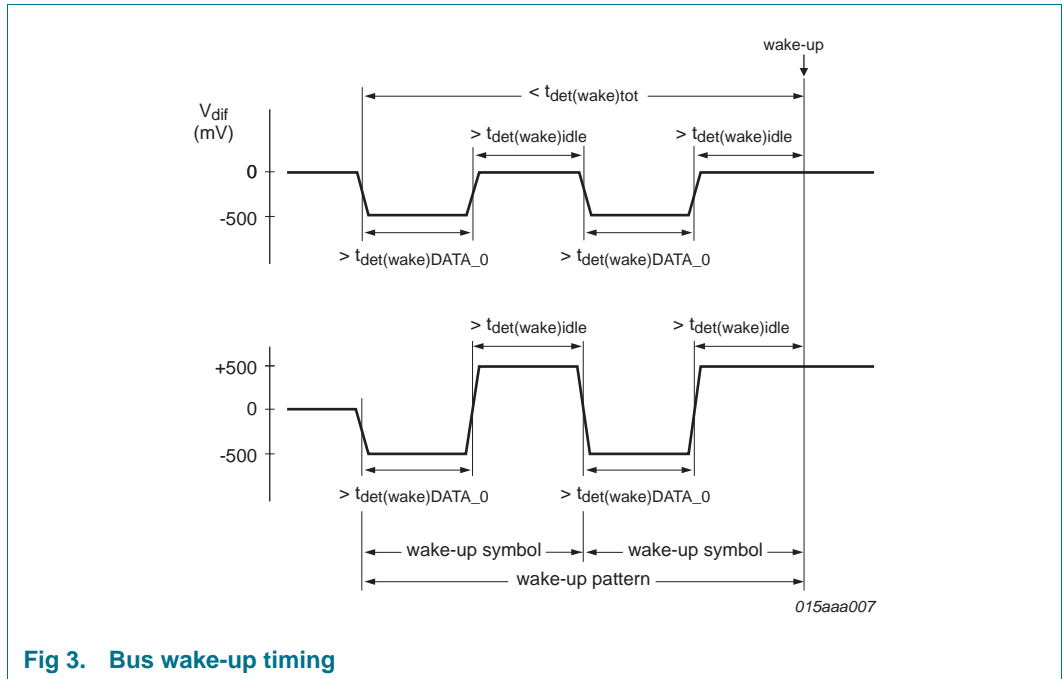

Fig 3. Bus wake-up timing

See [Ref. 1](#) for more details of the wake-up mechanism.

6.4.1.2 Bus wake-up via dedicated FlexRay data frame

The TJA1085 detects a wake-up event when a dedicated data frame emulating a valid wake-up pattern, as shown in [Figure 4](#), is received.

The Data\_0 and Data\_1 phases of the emulated wake-up symbol are interrupted by the Byte Start Sequence (BSS) preceding each byte in the data frame. With a data rate of 10 Mbit/s, the interruption has a maximum duration of 130 ns and does not prevent the transceiver from recognizing the wake-up pattern in the payload.

For longer interruptions at lower data rates (5 Mbit/s and 2.5 Mbit/s), the wake-up pattern should be used (see [Section 6.4.1.1](#)).



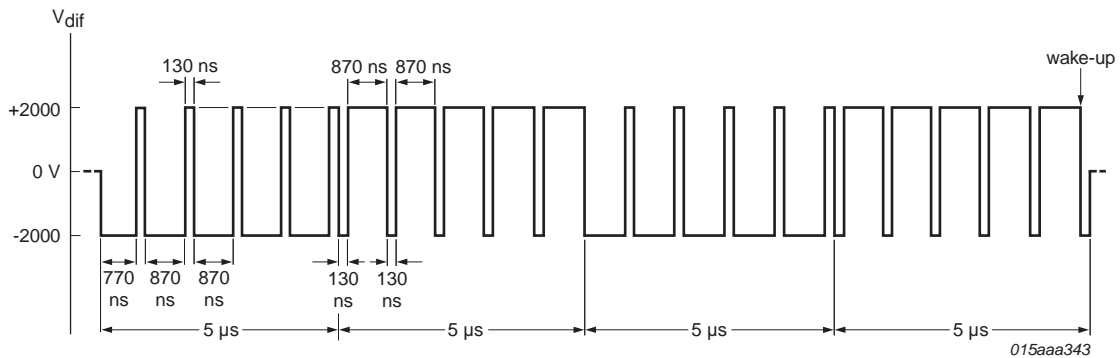

The duration of each interruption is 130 ns.

The transition time from DATA\_0 to DATA\_1 and vice versa is about 20 ns.

The TJA1085 wake-up flag is set on receipt of the following frame payload:

```
0xFF, 0xFF, 0xFF, 0xFF, 0xFF, 0x00, 0x00, 0x00, 0x00, 0x00,
0xFF, 0xFF, 0xFF, 0xFF, 0xFF, 0x00, 0x00, 0x00, 0x00, 0x00,
0xFF, 0xFF, 0xFF, 0xFF, 0xFF, 0x00, 0x00, 0x00, 0x00, 0x00,
0xFF, 0xFF, 0xFF, 0xFF, 0xFF
```

Fig 4. Minimum bus pattern for bus wake-up via dedicated FlexRay data frame

### 6.4.2 Local wake-up via pin LWU

Local wake-up is detected when the voltage on pin LWU is lower than  $V_{th(wake)(LWU)}$  for longer than  $t_{det(wake)(LWU)}$  (falling edge on pin LWU). When local wake-up is detected, the WU\_LOCAL status bit is set and a WU interrupt is generated. At the same time, the internal biasing of this pin is switched to pull-down.

If the voltage on pin LWU rises and remains above  $V_{th(wake)(LWU)}$  for longer than  $t_{det(wake)(LWU)}$  (rising edge on pin LWU), local wake-up is not detected and the biasing on pin LWU is switched to pull-up.

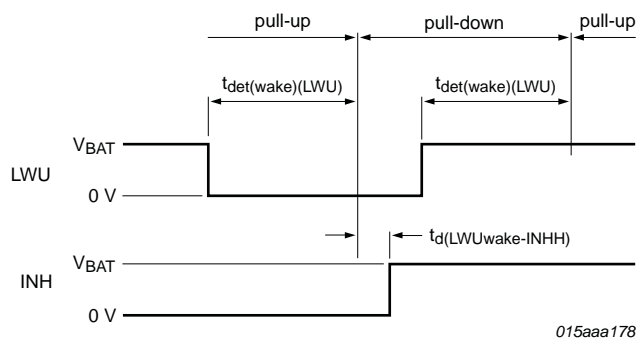

Fig 5. Local wake-up timing on pin LWU

### 6.4.3 Wake-up via the TRXD0/1 interface

If the voltage on pin TRXD0 or pin TRXD1 is LOW for longer than  $t_{det(wake)(TRXD)}$ , a WU interrupt is generated and the WU\_TRXD status bit is set.

## 6.5 Communication controller interface

### 6.5.1 Bus activity and idle detection

The following mechanisms for activity and idle detection are valid in normal power modes:

- If the absolute differential voltage on the bus lines is higher than  $|V_{i(dif)det(act)}|$  for  $t_{det(act)(bus)}$ , activity is detected on the bus lines
- If, after bus activity detection, the differential voltage on the bus lines is higher than  $V_{IH(dif)}$ , pin RXD will go HIGH
- If, after bus activity detection, the differential voltage on the bus lines is lower than  $V_{IL(dif)}$ , pin RXD will go LOW
- If the absolute differential voltage on the bus lines is lower than  $|V_{i(dif)det(act)}|$  for  $t_{det(idle)(bus)}$ , then idle is detected on the bus lines (pin RXD is switched HIGH or remains HIGH)

Additionally, activity and idle can be detected:

- if pin TXEN is LOW for longer than  $t_{det(act)(TXEN)}$ , activity is detected on pin TXEN
- if pin TXEN is HIGH for longer than  $t_{det(idle)(TXEN)}$ , idle is detected on pin TXEN
- if pin TRXD0 or TRXD1 is LOW for longer than  $t_{det(act)(TRXD)}$ , activity is detected on the TRXD0/1 interface
- if pins TRXD0 and TRXD1 are both HIGH for longer than  $t_{det(idle)(TRXD)}$ , idle is detected on the TRXD0/1 interface

**Table 3. Transmitter input signals: TXD, TXEN and BGE<sup>[1]</sup>**

TXD	TXEN	BGE	V <sub>IO</sub> UV detected	RXD	Bus	TRXD0	TRXD1	Operating mode
X	H	X	no	HIGH	idle	high ohmic <sup>[2]</sup>	high ohmic <sup>[2]</sup>	AS_Normal
X	X	L	no	HIGH	idle	high ohmic <sup>[2]</sup>	high ohmic <sup>[2]</sup>	AS_Normal
L	L	H	no	LOW	DATA_0	LOW	high ohmic <sup>[2]</sup>	AS_Normal
H	L	H	no	HIGH	DATA_1	high ohmic <sup>[2]</sup>	LOW	AS_Normal
X	X	X	no	HIGH	idle	high ohmic <sup>[2]</sup>	high ohmic <sup>[2]</sup>	AS_Standby, <sup>[3]</sup> AS_Sleep <sup>[3]</sup>
X	X	X	yes	LOW	idle	high ohmic <sup>[2]</sup>	high ohmic <sup>[2]</sup>	AS_Normal, AS_Standby, <sup>[3]</sup> AS_Sleep <sup>[3]</sup>
X	X	X	X	HIGH	float	high ohmic <sup>[2]</sup>	high ohmic <sup>[2]</sup>	AS_PowerOff, AS_Reset

[1] The transmitter is activated by a falling edge on pin TXD while TXEN is LOW and BGE is HIGH.

[2] Internal pull-up resistor (R<sub>pu</sub>) to V<sub>BUF</sub>.

[3] BP and BM biased to GND.

**Table 4. Bus as input**

Bus	V <sub>IO</sub> UV detected	RXD	TRXD0	TRXD1	Operating mode
DATA_0	no	LOW	LOW	high ohmic <sup>[1]</sup>	AS_Normal
DATA_1	no	HIGH	high ohmic <sup>[1]</sup>	LOW	AS_Normal
idle	no	HIGH	high ohmic <sup>[1]</sup>	high ohmic <sup>[1]</sup>	AS_Normal
X	no	HIGH	high ohmic <sup>[1]</sup>	high ohmic <sup>[1]</sup>	AS_Standby, AS_Sleep

Table 4. Bus as input

Bus	V <sub>IO</sub> UV detected	RXD	TRXD0	TRXD1	Operating mode
DATA_0	yes	LOW	LOW	high ohmic <sup>[1]</sup>	AS_Normal
DATA_1	yes	LOW	high ohmic <sup>[1]</sup>	LOW	AS_Normal
idle	yes	LOW	high ohmic <sup>[1]</sup>	high ohmic <sup>[1]</sup>	AS_Normal
X	yes	LOW	high ohmic <sup>[1]</sup>	high ohmic <sup>[1]</sup>	AS_Standby, AS_Sleep
X	X	HIGH	high ohmic <sup>[1]</sup>	high ohmic <sup>[1]</sup>	AS_PowerOff, AS_Reset

[1] Internal pull-up resistor (R<sub>pu</sub>) to V<sub>BUF</sub>.

Table 5. TRXD0/1 interface configured as input

TRXD0	TRXD1	V <sub>IO</sub> UV detected	RXD	Bus	Operating mode
X	falling edge	no	HIGH	DATA_1	AS_Normal <sup>[1]</sup>
HIGH	HIGH	no	HIGH	idle	AS_Normal
falling edge	X	X	LOW	DATA_0	AS_Normal <sup>[1]</sup>
X	falling edge	yes	LOW	DATA_1	AS_Normal <sup>[1]</sup>
HIGH	HIGH	yes	LOW	idle	AS_Normal
LOW	LOW	X	LOW	DATA_0	collision detected on TRXD0/1

[1] Activity detected on TRXD0/TRXD1.

## 6.6 Bus error detection

The TJA1085 provides bus error detection on each branch during data transmission. When a transmit error (TxE\_BRx = 1) is detected on a branch, an EVENT\_BRx interrupt is generated to notify the host.

The following conditions trigger bus error detection:

- Short circuit BP to BM
- Short-circuit BP to GND
- Short-circuit BM to GND
- Short-circuit BP to V<sub>CC</sub> or V<sub>BAT</sub>
- Short-circuit BM to V<sub>CC</sub> or V<sub>BAT</sub>

## 6.7 Interrupt generation

Interrupts are generated when specific events take place or associated status bits in the General or Branch X status registers are set. When an interrupt is generated, the relevant interrupt status bit is set in the Interrupt Status register (see [Table 9](#)) and pin INTN is forced LOW.

Some interrupt status bits (PWON, WU, SPI\_ERROR and HC\_ERROR) are reset immediately after the Interrupt Status register has been read successfully (i.e. a rising edge on SCSN with no SPI\_ERROR).

The UV\_ERROR, CLAMP\_ERROR, TEMP\_ERROR and EVENT\_BRx status bits are reset after the flag (or flags) that triggered the interrupt has been reset and a successful read operation had been performed (these two events can occur in any order). Resetting these bits triggers a further falling edge on INTN to indicate to the host that the issue that triggered the interrupt has been resolved (except in the case of EVENT\_BRx if a branch wake-up event triggered the interrupt). See [Section 6.10.2.3](#) for further details.

INTN signaling conforms to the FlexRay Electrical Physical Layer specification V3.0.1 (see [Ref. 1](#)).

## 6.8 Operating modes

The TJA1085 features five operating modes.

AS\_PowerOff, AS\_Sleep and AS\_Standby are low-power modes in which the transceiver is unable to transmit or receive data streams on the bus. In AS\_PowerOff mode, only power-on reset detection is active. The SPI, the low-power receiver and wake-up detection are active in AS\_Sleep mode. Undervoltage detection is enabled on  $V_{CC}$ ,  $V_{BAT}$  and  $V_{BUF}$  in AS\_Standby and AS\_Normal modes.  $V_{IO}$  undervoltage detection is always enabled, except when the TJA1085 is in AS\_PowerOff mode.

In AS\_Normal mode, the TJA1085 can transmit and receive data streams on the bus.

Pin INH is HIGH in AS\_Normal, AS\_Standby and AS\_Reset, and floating in AS\_PowerOff and AS\_Sleep.

The dStarGoToSleep timer is started when the TJA1085 switches to AS\_Standby or AS\_Normal, or when idle is detected on the bus. The timer is halted and reset when activity is detected on the bus.

### 6.8.1 Operating mode transitions

#### 6.8.1.1 AS\_PowerOff

The TJA1085 switches to AS\_PowerOff from any mode if the internal supply to the state machine,  $V_{DIG}$ , falls below the power-on detection threshold voltage ( $V_{th(det)POR}$ ). It remains in AS\_PowerOff until  $V_{DIG}$  rises above the power-on recovery threshold voltage ( $V_{th(rec)POR}$ ), when it switches to AS\_Standby. Pins INTN and SDO are switched to a high-impedance state in AS\_PowerOff mode.

#### 6.8.1.2 AS\_Reset

The TJA1085 switches to AS\_Reset from any mode if pin RSTN goes LOW with no undervoltage detected on  $V_{IO}$ . It remains in AS\_Reset until pin RSTN goes HIGH, when it switches to AS\_Standby.

#### 6.8.1.3 AS\_Standby

The TJA1085 switches to AS\_Standby:

- from AS\_PowerOff when  $V_{DIG}$  rises above the power-on recovery threshold voltage ( $V_{th(rec)POR}$ )
- from AS\_Reset when pin RSTN goes HIGH
- from AS\_Normal when a  $V_{CC}$  undervoltage event is detected ( $V_{CC} < V_{uvd}(V_{CC})$ ) for longer than  $t_{det(uv)}(V_{CC})$

- from AS\_Normal in response to a host 'AS\_Standby' command (HC mode)
- from AS\_Sleep in response to a host 'AS\_Standby' command (HC mode)
- from AS\_Sleep when a wake-up event is detected

The TJA1085 switches from AS\_Standby:

- to AS\_Normal when a wake-up event is detected, provided  $V_{BUF} > V_{uvr(VBUF)}$
- to AS\_Normal when a  $V_{CC}$  undervoltage recovery event is detected ( $V_{CC} > V_{uvr(VCC)}$ ) for longer than  $t_{rec(uv)(VCC)}$ , provided  $V_{BUF} > V_{uvr(BUF)}$
- to AS\_Normal in response to a host 'AS\_Normal' command (HC mode)
- to AS\_Sleep if the dStarGoToSleep timer expires (AP mode)
- to AS\_Sleep if a  $V_{CC}$  undervoltage event lasts longer than  $t_{to(und)(VCC)}$  (HC mode)
- to AS\_Sleep in response to a host 'AS\_Sleep' command (HC mode)

#### 6.8.1.4 AS\_Sleep

A wake-up event will trigger a transition to AS\_Standby (followed by a transition to AS\_Normal if  $V_{BUF} > V_{uvr(VBUF)}$ ).

The TJA1085 switches to AS\_Sleep:

- from AS\_Standby in response to a host 'AS\_Sleep' command (HC mode)
- from AS\_Standby if the dStarGoToSleep timer expires (AP mode)
- from AS\_Standby if a  $V_{CC}$  undervoltage event lasts longer than  $t_{to(und)(VCC)}$  (HC mode)
- from AS\_Normal in response to a host 'AS\_Sleep' command (HC mode)
- from AS\_Normal if the dStarGoToSleep timer expires (AP mode)

The TJA1085 switches from AS\_Sleep:

- to AS\_Standby in response to a host 'AS\_Standby' command (HC mode)
- to AS\_Standby when a wake-up event is detected.
- to AS\_Normal in response to a host 'AS\_Normal' command (HC mode)

#### 6.8.1.5 AS\_Normal

The TJA1085 switches to AS\_Normal:

- from AS\_Standby if a  $V_{CC}$  undervoltage recovery event is detected ( $V_{CC} > V_{uvr(VCC)}$ ) for longer than  $t_{rec(uv)(VCC)}$ , provided  $V_{BUF} > V_{uvr(BUF)}$
- from AS\_Standby if a wake-up event is detected, provided  $V_{BUF} > V_{uvr(VBUF)}$  for longer than  $t_{rec(uv)(VBUF)}$
- from AS\_Standby or AS\_Sleep in response to a host 'AS\_Normal' command

The TJA1085 switches from AS\_Normal:

- to AS\_Standby when a  $V_{CC}$  undervoltage event is detected ( $V_{CC} < V_{udv(VCC)}$ ) for longer than  $t_{det(uv)(VCC)}$

- if the TJA1085 is in HC mode, it will switch from AS\_Standby to AS\_Sleep if the  $V_{CC}$  undervoltage persists for longer than  $t_{to(uvd)(VCC)}$
- if the TJA1085 is in AP mode, it will switch to AS\_Sleep when the dStarGoToSleep timer expires
- to AS\_Standby in response to a host 'AS\_Standby' command (HC mode)
- to AS\_Sleep in response to a host 'AS\_Sleep' command (HC mode)
- to AS\_Sleep if the dStarGoToSleep timer expires (AP mode)

6.8.1.6 Operating mode transition diagram

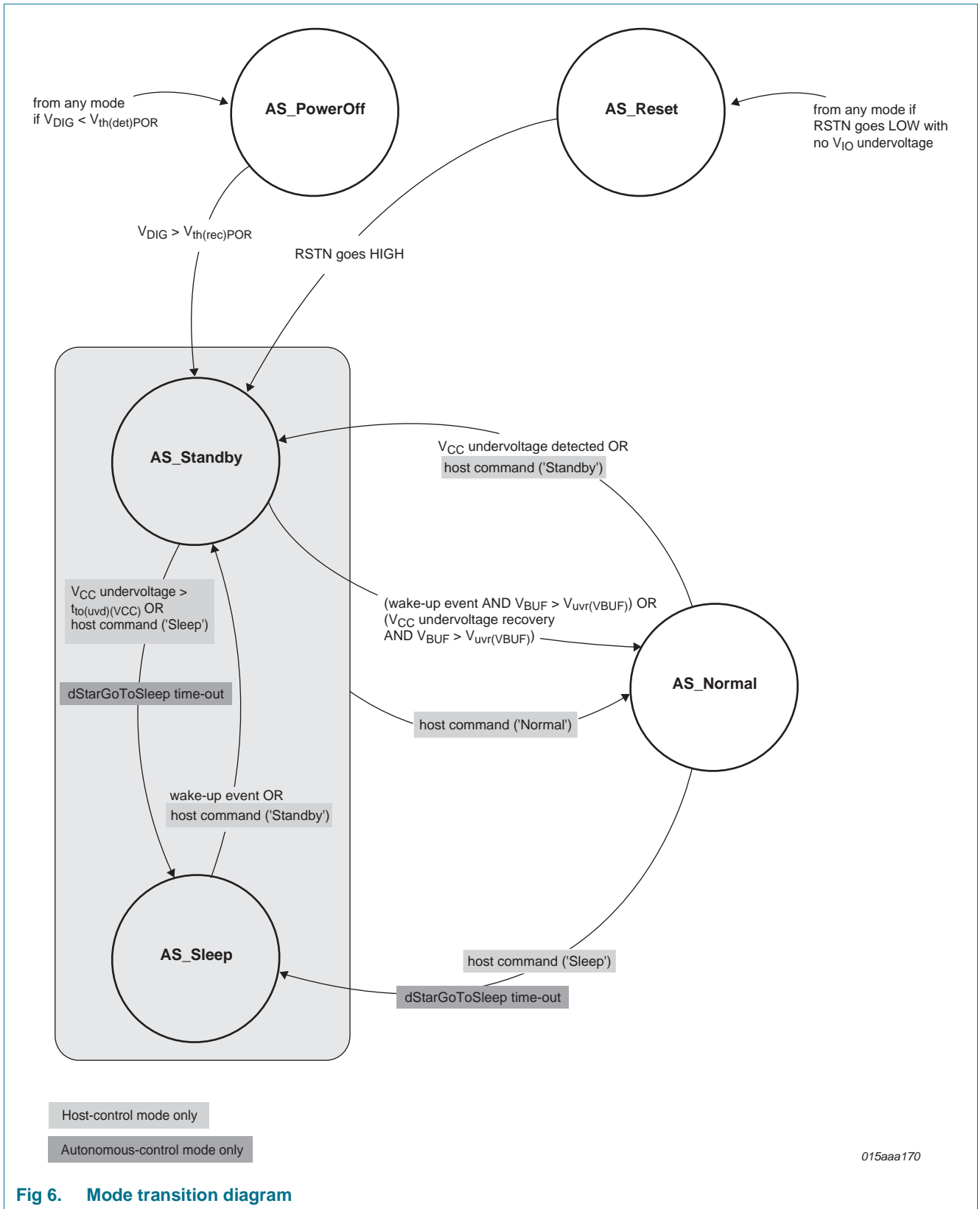

Fig 6. Mode transition diagram

## 6.9 Branch operating modes

Each of the four branches in the TJA1085 features six branch operating modes:

- **Branch\_Off**  
All branches are in Branch\_Off mode when the TJA1085 is in AS\_PowerOff or AS\_Reset mode. The transmitter, normal receiver, low-power receiver and bus error detection are disabled. The bus pins are floating.
- **Branch\_LowPower**  
All branches are in Branch\_LowPower mode when the TJA1085 is in AS\_Standby or AS\_Sleep mode. The transmitter, the normal receiver and bus error detection are disabled. The low-power receiver is active (i.e. remote wake-up is possible). The bus pins are biased to ground.
- **Branch\_Disabled**  
The TJA1085 switches to Branch\_Disabled if an overtemperature is detected. The 'Branch\_Disabled' and 'Branch\_Normal' commands allow the host to enable/disable a branch without affecting the remaining branches. The transmitter, normal receiver and bus error detection are disabled. Only the low-power receiver is active (remote wake-up is possible). The bus pins are biased to  $V_{o(idle)(BP)}$  and  $V_{o(idle)(BM)}$ .
- **Branch\_Normal**  
When a branch is in Branch\_Normal, the TJA1085 will be in AS\_Normal. The transmitter, normal receiver and bus error detection are active. The bus pins are biased to  $V_{o(idle)(BP)}$  and  $V_{o(idle)(BM)}$ .
- **Branch\_TxOnly1**  
In Branch\_TxOnly1 mode, the receiver is disabled, i.e. the received data is not forwarded to the signal router. The transmitter is active and bus error detection is active. The bus pins are biased to  $V_{o(idle)(BP)}$  and  $V_{o(idle)(BM)}$ .
- **Branch\_TxOnly2**  
This mode is host-controlled only and is operationally identical to Branch\_TxOnly1. It allows the host to switch off the receiver in response to error conditions.
- **Branch\_FailSilent**  
The transmitter, the low-power receiver and bus error detection are disabled. Only the receiver remains active to monitor the branch for idle or activity. Received data is not forwarded to the signal router. The bus pins are biased to  $V_{o(idle)(BP)}$  and  $V_{o(idle)(BM)}$ .

### 6.9.1 Branch operating mode transitions

Branch-related host commands can only be issued when the TJA1085 is in AS\_Normal mode.

#### 6.9.1.1 Branch\_Off

When the TJA1085 enters AS\_PowerOff or AS\_Reset, all four branches switch to Branch-Off. When the TJA1085 subsequently switches to AS\_Standby, all four branches switch to Branch\_LowPower.

#### 6.9.1.2 Branch\_LowPower

All four branches switch to Branch\_LowPower when the TJA1085 enters AS\_Standby or AS\_Sleep. All branches remain in this mode until the TJA1085 enters AS\_Normal. When this transition happens, branches that were in Branch\_Disabled before switching to Branch\_LowPower return to Branch\_Disabled. The remaining branches switch to Branch\_Normal.



### 6.9.1.3 Branch\_Disabled

An overtemperature event (TEMP\_HIGH flag set) triggers a transition from Branch\_Normal to Branch\_Disabled in all branches.

If an overtemperature event triggered the transition from Branch\_Normal to Branch\_Disabled, all branches return to Branch\_Normal when the overtemperature problem has been resolved (TEMP\_WARN flag reset).

The 'Branch\_Disabled' and 'Branch\_Normal' commands can be used to enable/disable individual branches. A host command is also available to trigger a transition from Branch\_Disabled to Branch\_TxOnly1 ('Branch\_TxOnly').

If a branch switches from Branch\_Disabled to Branch\_LowPower because the TJA1085 has entered AS\_Standby or AS\_Sleep, it will return to Branch\_Disabled when the TJA1085 enters AS\_Normal.

### 6.9.1.4 Branch\_FailSilent

A branch switches to Branch\_FailSilent:

- from Branch\_Normal if a branch is clamped (Clamp\_BRx flag set), provided clamp-detection is enabled (bit CLAMP\_DET set; see [Table 8](#))
- from Branch\_Normal if a transmit error (TxE\_BRx = 1) is detected, provided autonomous error confinement is enabled (bit AEC set; see [Table 8](#))
- from Branch\_TxOnly1 if a transmit error (TxE\_BRx = 1) is detected.

The branch remains in Branch\_FailSilent until idle is detected on all branches, when it switches to Branch\_TxOnly1 (a 'Branch\_TxOnly' command is needed in HC mode).

### 6.9.1.5 Branch\_TxOnly1

A branch switches to Branch\_TxOnly1:

- from Branch\_Disabled in response to a 'Branch\_TxOnly' command (HC mode)
- from Branch\_FailSilent in response to a 'Branch\_TxOnly' command when all branches are idle (HC mode)
- from Branch\_FailSilent when all branches are idle (AP mode)

A branch switches from Branch\_TxOnly1:

- to Branch\_Normal when a transmission ends without error
- to Branch\_FailSilent if a transmit error is detected (TxE\_BRx = 1)

### 6.9.1.6 Branch\_TxOnly2

This mode is purely host controlled. A branch switches to Branch\_TxOnly2 only in response to a 'Branch\_TxOnly' command issued in Branch\_Normal mode. The branch remains in Branch\_TxOnly2 mode until a 'Branch\_Normal' command is received.

### 6.9.1.7 Branch\_Normal

A branch switches to Branch\_Normal:

- from Branch\_LowPower when the TJA1085 enters AS\_Normal mode (provided it was not in Branch\_Disabled before the transition to Branch\_LowPower mode)

- from Branch\_TxOnly2 in response to a host 'Branch\_Normal' command
- from Branch\_TxOnly1 when a transmission ends without error
- from Branch\_Disabled in response to a host 'Branch\_Normal' command
- from Branch\_Disabled when an overtemperature is resolved (TEMP\_WARN = 0), provided the overtemperature triggered the earlier transition to Branch\_Disabled.

A branch switches from Branch\_Normal:

- to Branch\_FailSilent if a branch is clamped, provided clamp-detection is enabled (CLAMP\_DET = 1)
- to Branch\_FailSilent if a transmit error is detected, provided bit AEC = 1
- to Branch\_TxOnly2 if a host 'Branch\_TxOnly' command is received
- to Branch\_Disabled if an overtemperature event is detected (TEMP\_HIGH = 1)

6.9.1.8 Branch operating mode transition diagram

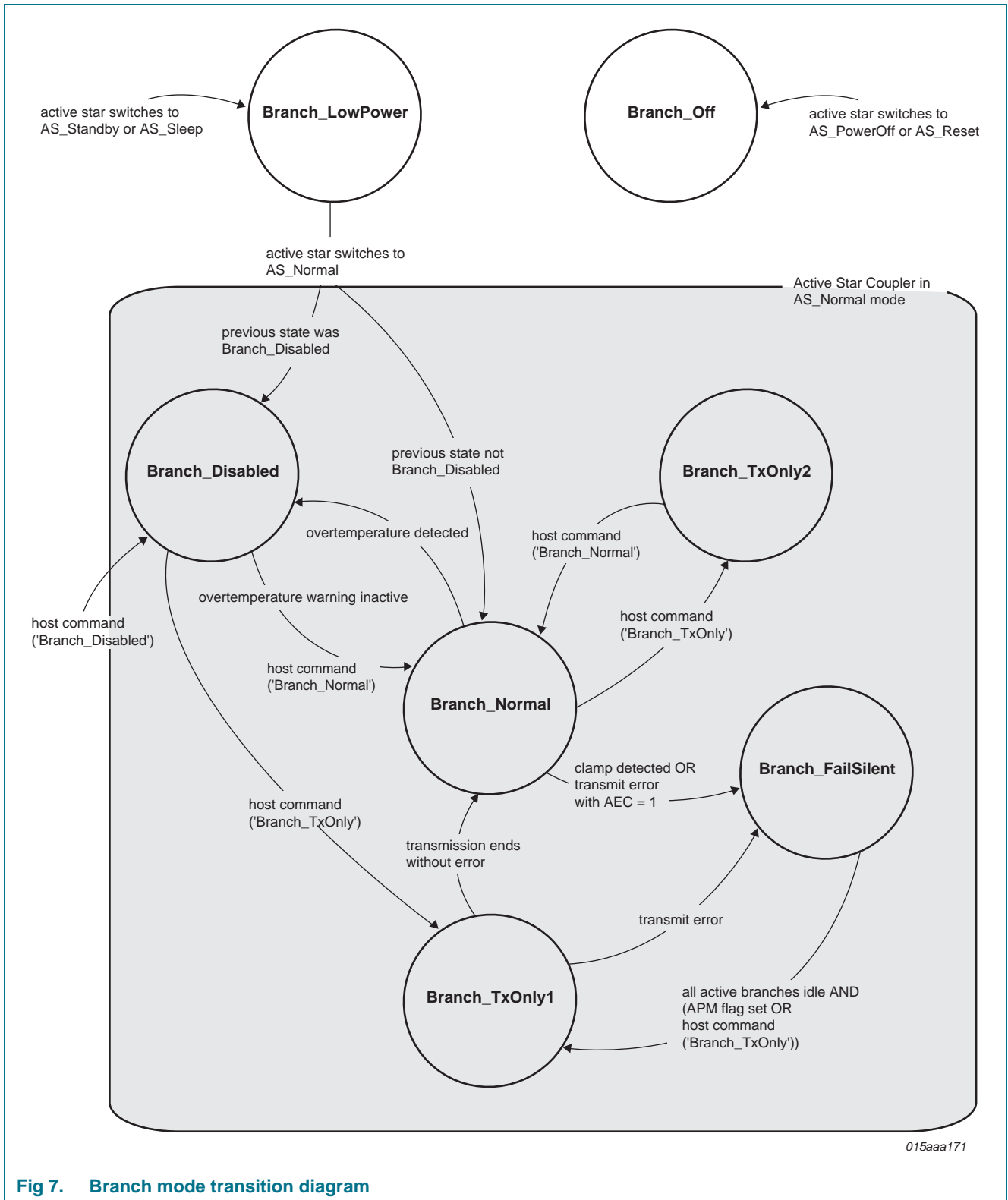

Fig 7. Branch mode transition diagram

6.10 SPI interface

The TJA1085 contains a bidirectional 16-bit Serial Peripheral Interface (SPI) for communicating with a host. The SPI allows the host to configure the TJA1085 and to access error and status information.

6.10.1 Register access

The SPI supports full duplex data transfer, so status information is read out on pin SDO while control data is being shifted in on pin SDI. Bit sampling is performed on the falling edge of the clock signal on pin SCLK and data is shifted on the rising edge (MSB first; see Figure 8).

The clock signal must be LOW when SCSN goes LOW to initiate an SPI register access cycle.

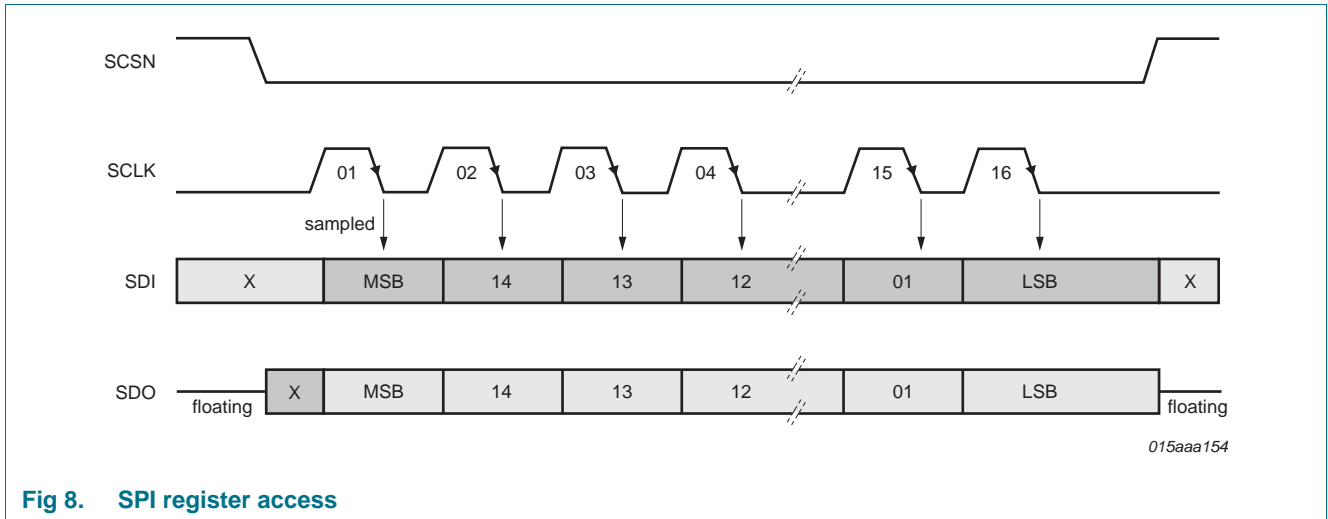

Fig 8. SPI register access

6.10.2 SPI registers

The SPI register structure in the TJA1085 is illustrated in Figure 9. The three MSBs (bits 15 to 13) contain the 3-bit register address. Bit 12 defines the selected register access as read/write or read only. If bit 12 is 1, the SPI data transfer will be read only and all data on the SDI pin will be ignored. If bit 12 is 0, data bits 11 to 0 will be written to the selected register.

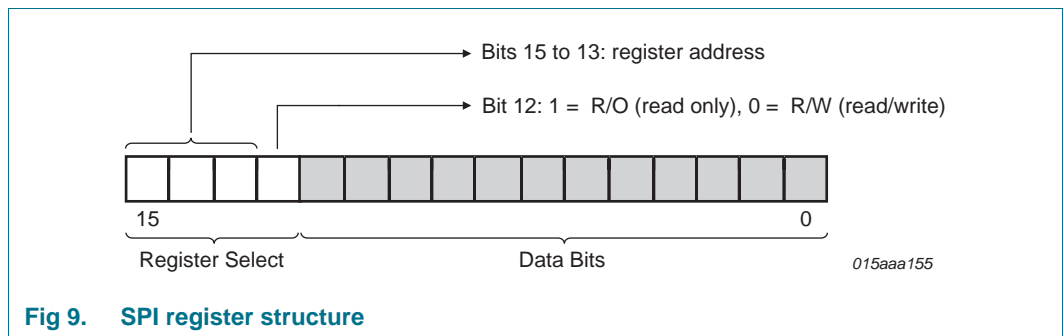

Fig 9. SPI register structure

The assignment of control and status register addresses is detailed in [Table 6](#). Data can only be written to the Control and Configuration registers (status registers are read-only by definition). Therefore the state of bit 12 is only evaluated when these registers are being accessed.

**Table 6. Register map**

Address bits 15, 14 and 13	Write access bit 12 <sup>[1]</sup>	Register
000	0 =R/W, 1 = R/O	Control register; see <a href="#">Table 7</a>
001	1 = R/O	Interrupt status register; see <a href="#">Table 9</a>
010	1 = R/O	General status register; see <a href="#">Table 10</a>
011	1 = R/O	Branch 1 status register; see <a href="#">Table 11</a>
100	1 = R/O	Branch 2 status register; see <a href="#">Table 11</a>
101	1 = R/O	Branch 3 status register; see <a href="#">Table 11</a>
110	1 = R/O	Branch 4 status register; see <a href="#">Table 11</a>
111	0 =R/W, 1 = R/O	Configuration register; see <a href="#">Table 8</a>

[1] Bit 12 is assumed to be 1 for status registers

The following subsections provide details of the bits in these registers and the control and status functionality assigned to each.

### 6.10.2.1 Control register

The read/write Control register allows the host controller to set the operating modes and to switch the TJA1085 between HC and AP modes.

**Table 7. Control register bit description**

Bit	Symbol	Access	Default	Description
11:10	OPM	R/W	00	operating mode: 00: no change 01: AS_Standby 10: AS_Sleep 11: AS_Normal
9:8	CTRL_BR1	R/W	00	branch 1 control: 00: no change 01: Branch_Normal 10: Branch_TxOnly 11: Branch_Disabled
7:6	CTRL_BR2	R/W	00	branch 2 control: 00: no change 01: Branch_Normal 10: Branch_TxOnly 11: Branch_Disabled
5:4	CTRL_BR3	R/W	00	branch 3 control: 00: no change 01: Branch_Normal 10: Branch_TxOnly 11: Branch_Disabled
3:2	CTRL_BR4	R/W	00	branch 4 control: 00: no change 01: Branch_Normal 10: Branch_TxOnly 11: Branch_Disabled
1	APM <sup>[1]</sup>	R/W	1	Autonomous Power mode 0: disabled 1: enabled
0	RESET_ERROR <sup>[2]</sup>	R/W	0	reset error flags and status bits 0: no change 1: reset flags/bits

[1] The TJA1085 sets the APM flag at power-on, in response to a wake-up event (local, remote or TRXD), if a  $V_{CC}$  undervoltage is detected in AS\_Normal or a  $V_{IO}$  undervoltage is detected for longer than  $t_{to(und)}(V_{IO})$ .

[2] Setting the RESET\_ERROR bit resets all error status bits in the General Status (bits 8 to 1) and Branch Status registers (bits 7 to 4).

### 6.10.2.2 Configuration register

The read/write Configuration register allows the host controller to configure a number of TJA1085 parameters and functions.

**Table 8. Configuration register bit description**

Bit	Symbol	Access	Default	Description
11	AEC	R/W	0	Autonomous error confinement: 0: disabled 1: enabled
10	BFT	R/W	1	Bus failure timer 0: disabled 1: enabled
9	WUD_BR1	R/W	1	wake-up detection on branch 1: 0: disabled 1: enabled
8	WUD_BR2	R/W	1	wake-up detection on branch 2: 0: disabled 1: enabled
7	WUD_BR3	R/W	1	wake-up detection on branch 3: 0: disabled 1: enabled
6	WUD_BR4	R/W	1	wake-up detection on branch 4: 0: disabled 1: enabled
5	CC_EN	R/W	0	CC interface enable (TXD and TXEN inputs; RXD output): 0: disabled 1: enabled
4	TRXD_EN	R/W	1	TRXD interface enable: 0: disabled 1: enabled
3	reserved			always 0
2	CLAMP_DET	R/W	1	clamping detection: 0: disabled 1: enabled
1	BIT_LATCHING	R/W	0	status bit latching: 0: disabled 1: enabled
0	PARITY	R	-	parity bit - odd parity (including parity bit)

**Autonomous Error Confinement (AEC):**

Setting the AEC bit enables the autonomous error confinement feature of the TJA1085.

When AEC is enabled, a bus error (TxE\_BRx = 1) triggers a transition from Branch\_Normal to Branch\_FailSilent. AEC is disabled by default.

**Bus Failure Timer (BFT):**

Setting the BFT bit enables the bus failure timer.

When the BFT is enabled, pulses shorter than  $t_{to(BFT)}$  are ignored, resulting in more robust bus error detection. The BFT is enabled by default.

**Wake-up detection on branch x (WUD\_BRx):**

Setting the WUD\_BRx bit enables wake-up detection on the specified branch.

Each branch in a TJA1085 star network contains a low-power receiver for detecting remote wake-up events. These events can be enabled and disabled individually. This feature makes it possible to minimize quiescent current consumption, especially in AS\_Sleep mode. Wake-up detection is enabled by default on all branches.

**Communication Controller interface Enable (CC\_EN):**

Setting bit CC\_EN enables the communication controller interface.

A communication controller can be connected to the TJA1085 when CC\_EN = 1. If CC\_EN = 0, the RXD output driver is switched off to minimize current consumption in AS\_Normal mode. The CC interface is disabled by default.

**TRXD0/1 interface Enable (TRXD\_EN):**

Setting bit TRXD\_EN enables the TRXD0 and TRXD1 interfaces.

When the TRXD0/1 interfaces are enabled, several TJA1085 devices can be connected together to form a single active star. If only one TJA1085 is needed at any time, the TRXD0/1 interfaces can be disabled to minimize current consumption in AS\_Normal mode. The TRXD0 and TRXD1 interfaces are enabled by default.

**Clamp detection (CLAMP\_DET):**

Setting bit CLAMP\_DET enables clamp detection on TXEN, TRXD and on the four branches.

When clamp detection is enabled, a CLAMP\_ERROR interrupt is generated if clamping is detected on TXEN (CLAMP\_TXEN = 1), TRXD (CLAMP\_TRXD = 1) or on a branch (CLAMP\_BRx). Clamp detection is enabled by default.

**Bit latching (BIT\_LATCHING):**

When bit latching is enabled (BIT\_LATCHING = 1), the status bits in the General and Branch X status registers reflect the latched state until the register is read. Once the register has been read, latching is released and the bits then reflect the current 'live' status. When bit latching is disabled, the status bits reflect the 'live' status at all times. Bit latching is disabled by default.



### 6.10.2.3 Interrupt Status register

The Interrupt Status register is read-only. When the TJA1085 sets a bit in this register, it triggers a falling edge on pin INTN. Bits PWON, WU, SPI\_ERROR and HC\_ERROR are reset after a successful read operation. The remaining bits are reset after the flag (or flags) that triggered the interrupt has been reset and a successful read operation has been performed (see [Section 6.7](#)).

**Table 9. Interrupt status register**

Bit	Symbol	Description
11	PWON	power-on detection: 0: no power-on detected 1: power-on detected
10	WU	wake-up event detection (any): 0: no wake-up event detected 1: wake-up event detected
9	EVENT_BR1	wake-up or bus error detection on branch 1: 0: no wake-up or bus error detected 1: wake-up or bus error detected
8	EVENT_BR2	wake-up or bus error detection on branch 2: 0: no wake-up or bus error detected 1: wake-up or bus error detected
7	EVENT_BR3	wake-up or bus error detection on branch 3: 0: no wake-up or bus error detected 1: wake-up or bus error detected
6	EVENT_BR4	wake-up or bus error detection on branch 4: 0: no wake-up or bus error detected 1: wake-up or bus error detected
5	UV_ERROR	undervoltage detected on $V_{BAT}$ , $V_{CC}$ or $V_{IO}$ : 0: no undervoltage detected 1: undervoltage detected
4	CLAMP_ERROR	clamp error on TRXD, TXEN or branch or collision on TRXD: 0: no clamping error detected 1: clamping error detected
3	SPI_ERROR	SPI communication error: 0: not detected 1: detected
2	HC_ERROR	host command error: 0: not detected 1: detected
1	TEMP_ERROR	overtemperature error: 0: not detected 1: detected
0	PARITY	parity bit - odd parity (including parity bit)

**PWON:** A PWON interrupt is generated to signal a power-on event.

The PWON interrupt status bit is set when the TJA1085 leaves AS\_PowerOff or AS\_Reset. It is reset after a successful read operation on the Interrupt Status register.

**WU:** A WU interrupt indicates the occurrence of a wake-up event.

The WU interrupt status bit is set when a wake-up event is detected on a branch (WU\_BRx = 1), on TRXD0/1 (WU\_TRXD = 1), or on LWU (WU\_LOCAL = 1). It is reset after a successful read operation on the Interrupt Status register.

**EVENT\_BRx:** An EVENT\_BRx interrupt signals the occurrence of a significant event on the relevant branch.

The EVENT\_BRx interrupt status bit is set when any of the following events is detected on a branch:

- a wake-up event (WU\_BRx = 1)
- a bus error (TxE\_BRx = 1)
- clamping (CLAMP\_BRx = 1)

It is reset after the flag (or flags) that triggered the interrupt has been reset and the Interrupt Status register has been read successfully. Resetting EVENT\_BRx will trigger a falling edge on INTN to indicate to the host that the event that triggered the interrupt has been resolved (except when the interrupt was triggered by a branch wake-up event).

**UV\_ERROR:** A UV\_ERROR interrupt indicates that an undervoltage has occurred.

The UV\_ERROR interrupt status bit is set when a V<sub>BAT</sub> (UV\_VBAT = 1), V<sub>CC</sub> (UV\_VCC = 1) or V<sub>IO</sub> (UV\_VIO = 1) undervoltage is detected. It is reset after the flag (or flags) that triggered the interrupt has been reset and the Interrupt Status register has been read successfully. Resetting UV\_ERROR triggers a falling edge on INTN to indicate to the host that the undervoltage condition is no longer present.

**CLAMP\_ERROR:** A CLAMP\_ERROR interrupt indicates that an input channel has become clamped or a collision has occurred on the TRXD0/1 interface.

The CLAMP\_ERROR interrupt status bit is set when clamping is detected on TRXD (CLAMP\_TRXD = 1), on TXEN (CLAMP\_TXEN = 1) or on a branch (CLAMP\_BRx = 1) or if a collision is detected on TRXD0/TRXD1 (COLL\_TRXD = 1). It is reset after the flag (or flags) that triggered the interrupt has been reset and the Interrupt Status register has been read successfully. Resetting CLAMP\_ERROR triggers a falling edge on INTN to indicate to the host that the clamp or collision error has been corrected.

**SPI\_ERROR:** An SPI\_ERROR interrupt indicates that an error has occurred during SPI communications.

The SPI\_ERROR interrupt status bit is set if the number of SCLK cycles generated during a LOW phase on SCSN does not equal 16. It is reset after a successful read operation on the Interrupt Status register.

**HC\_ERROR:** A HC\_ERROR interrupt indicates that an invalid host command has been received.

The HC\_ERROR interrupt status bit is set when the host requests an illegal mode transition (as defined in the [Section 6.8.1](#) and [Section 6.9.1](#)). It is reset after a successful read operation on the Interrupt Status register.

**TEMP\_ERROR:** A TEMP\_ERROR interrupt signals the presence of an overtemperature condition.

The TEMP\_ERROR interrupt status bit is set when the temperature warning level (TEMP\_WARN = 1) or temperature high level (TEMP\_HIGH = 1) is exceeded. It is reset after the flag (or flags) that triggered the interrupt has been reset and the Interrupt Status register has been read successfully. Resetting TEMP\_ERROR triggers a falling edge on INTN to indicate to the host that the overtemperature condition is no longer present.

### 6.10.2.4 General Status register

The read-only General Status register contains status information not included in the Interrupt status register.

**Table 10. General status register**

Bit	Symbol	Description
11	WU_LOCAL	local wake-up on pin LWU: 0: no wake-up detected 1: wake-up detected
10	WU_TRXD	wake-up via TRXD0/TRXD1 0: no wake-up detected 1: wake-up detected
9	BGE_FB	BGE status feedback: 0: if BGE is LOW 1: if BGE is HIGH
8	UV_VBAT	V <sub>BAT</sub> undervoltage 0: no undervoltage detected 1: undervoltage detected
7	UV_VCC	V <sub>CC</sub> undervoltage 0: no undervoltage detected 1: undervoltage detected
6	UV_VIO	V <sub>IO</sub> undervoltage 0: no undervoltage detected 1: undervoltage detected
5	TEMP_WARN	temperature warning level 0: not exceeded 1: exceeded
4	TEMP_HIGH	temperature high level 0: not exceeded 1: exceeded
3	CLAMP_TRXD	clamping detection on TRXD: 0: not detected 1: detected
2	CLAMP_TXEN	clamping detection on TXEN: 0: not detected 1: detected
1	COLL_TRXD	collision detection on TRXD0 and TRXD1: 0: not detected 1: detected
0	PARITY	parity bit - odd parity (including parity bit)

**WU\_LOCAL:**

WU\_LOCAL is set when a local wake-up event is detected. A WU interrupt is generated.

WU\_LOCAL is reset after the General Status register has been read successfully or when the TJA1085 switches from AS\_Normal to AS\_Standby or AS\_Sleep. This ensures that a new wake-up event will be detected.

**WU\_TRXD:**

WU\_TRXD is set when a wake-up event is detected on the TRXD0/1 interface. A WU interrupt is generated.

WU\_TRXD is reset after the General Status register has been read successfully or when the TJA1085 switches from AS\_Normal to AS\_Standby or AS\_Sleep. This ensures that a new wake-up event will be detected.

**BGE\_FB:**

Bit BGE\_FB provides information about the voltage level on pin BGE.

BGE\_FB is set when the voltage on BGE is HIGH and reset when the voltage on BGE is LOW.

**UV\_VBAT:**

UV\_VBAT is set when a  $V_{BAT}$  undervoltage is detected, generating a UV\_ERROR interrupt.

If bit latching is enabled ( $BIT\_LATCHING = 1$ ), UV\_VBAT will remain set until the General Status register has been read, after which it will reflect the current 'live' situation (set if  $V_{BAT} < V_{uvd}(VBAT)$  for longer than  $t_{det(uv)}(VBAT)$  and reset if  $V_{BAT} > V_{uvr}(VBAT)$  for longer than  $t_{rec(uv)}(VBAT)$ ). If bit latching is not enabled, UV\_VBAT will reflect the 'live' situation at all times.

**UV\_VCC:**

UV\_VCC is set when a  $V_{CC}$  undervoltage is detected, generating a UV\_ERROR interrupt.

If bit latching is enabled ( $BIT\_LATCHING = 1$ ), UV\_VCC will remain set until the General Status register has been read, after which it will reflect the current 'live' situation (set if  $V_{CC} < V_{uvd}(VCC)$  for longer than  $t_{to(und)}(VCC)$  and reset if  $V_{CC} > V_{uvr}(VCC)$  for longer than  $t_{to(uvr)}(VCC)$ ). If bit latching is not enabled, UV\_VCC will reflect the 'live' situation at all times.

**UV\_VIO:**

UV\_VIO is set when a  $V_{IO}$  undervoltage is detected, generating a UV\_ERROR interrupt.

If bit latching is enabled ( $BIT\_LATCHING = 1$ ), UV\_VIO will remain set until the General Status register has been read, after which it will reflect the current 'live' situation (set if  $V_{IO} < V_{uvd}(VIO)$  for longer than  $t_{to(und)}(VIO)$  and reset if  $V_{IO} > V_{uvr}(VIO)$  for longer than  $t_{to(uvr)}(VIO)$ ). If bit latching is not enabled, UV\_VIO will reflect the 'live' situation at all times.

When a  $V_{IO}$  undervoltage is active, the digital inputs are disabled and the TJA1085 is unable to accept Host commands. If the  $V_{IO}$  undervoltage persists for longer than  $t_{to(und)}(VIO)$ , the APM flag is set and the TJA1085 switches from Host control to Autonomous control.

**TEMP\_WARN:**

TEMP\_WARN is set when the junction temperature rises above the temperature warning level, generating a TEMP\_ERROR interrupt.

If bit latching is enabled (BIT\_LATCHING = 1), TEMP\_WARN will remain set until the General Status register has been read, after which it will reflect the current 'live' situation (set when  $T_j > T_{j(\text{warn})}$  and reset when  $T_j < T_{j(\text{warn})}$  with no activity on the bus or on the CC and TRXD0/1 interfaces). If bit latching is not enabled, TEMP\_WARN will reflect the 'live' situation at all times.

**TEMP\_HIGH:**

TEMP\_HIGH is set when the junction temperature rises above the temperature high level. The output driver on the TRXD0/1 interface is disabled along with the branch transmitters (all branches switch to Branch\_Disabled). A TEMP\_ERROR interrupt is generated.

If bit latching is enabled (BIT\_LATCHING = 1), TEMP\_HIGH will remain set until the General Status register has been read, after which it will reflect the current 'live' situation (set when  $T_j > T_{j(\text{high})}$  and reset when  $T_j < T_{j(\text{high})}$  with no activity on the bus or on the CC and TRXD0/1 interfaces). If bit latching is not enabled, TEMP\_HIGH will reflect the 'live' situation at all times.

**CLAMP\_TRXD:**

CLAMP\_TRXD is set when the TRXD0/1 interface is configured as an input and TRXD0 or TRXD1 is clamped LOW for longer than  $t_{\text{detCL}}(\text{TRXD})$ . The output driver on the TRXD0/1 interface is disabled and data on the inputs is ignored. A CLAMP\_ERROR interrupt is generated.

If bit latching is enabled, CLAMP\_TRXD will remain set until the General Status register has been read, after which it will reflect the current 'live' situation (set when TRXD0 or TRXD1 clamped LOW and reset when TRXD0 and TRXD1 are HIGH). If bit latching is not enabled, CLAMP\_TRXD will reflect the 'live' situation at all times.

**CLAMP\_TXEN:**

CLAMP\_TXEN is set when the TXEN is clamped LOW for longer than  $t_{\text{detCL}}(\text{TXEN})$ . Data on TXD/TXEN is ignored and a CLAMP\_ERROR interrupt is generated.

If bit latching is enabled, CLAMP\_TXEN will remain set until the General Status register has been read, after which it will reflect the current 'live' situation (set when TXEN clamped LOW and reset when TXEN is HIGH). If bit latching is not enabled, CLAMP\_TXEN will reflect the 'live' situation at all times.

**COLL\_TRXD:**

COLL\_TRXD is set when a collision is detected on the TRXD0/1 interface (TRXD0 and TRXD1 LOW for longer than  $t_{\text{det(col)}}(\text{TRXD})$ ). A CLAMP\_ERROR interrupt is generated.

COLL\_TRXD is reset once the General Status register has been read.

### 6.10.2.5 Branch X status registers

There is a dedicated read-only status register for each branch, i.e. there are four Branch X status registers in total. Each register contains relevant status information of a branch.

**Table 11. Branch X status register**

Bit	Symbol	Description
11-9	STATE_BRx	state of active branch: 000: Branch_Normal mode 001: Branch_Disabled mode 010: Branch_LowPower mode 011: Branch_TxOnly_2 mode 100: Branch_FailSilent mode 101: Branch_TxOnly_1 mode
8	WU_BRx	wake-up status 0: no wake-up detected 1: wake-up detected
7	reserved	always 0
6	TxE_BRx	transmit error on branch 0: not detected 1: detected
5	reserved	always 0
4	CLAMP_BRx	clamp detection on branch 0: not detected 1: detected
3	reserved	always 0
2	reserved	always 1
1	reserved	always 0
0	PARITY	parity bit - odd parity (including parity bit)

**STATE\_BRx:**

Bits STATE\_BRx indicate the current branch operating mode.

**WU\_BRx:**

WU\_BRx is set when a remote wake-up event is detected on a branch. A WU interrupt is generated along with an EVENT\_BRx interrupt to indicate the branch where the wake-up pattern or dedicated data frame was detected.

WU\_BRx is reset after the Branch Status register has been read successfully or when the TJA1085 switches from AS\_Normal to AS\_Standby or AS\_Sleep. This ensures that a new wake-up event will be detected.

**TxE\_BRx:**

TxE\_BRx is set when a transmit error is detected on a branch, generating an EVENT\_BRx interrupt. A transmit error is detected when there is a mismatch between the transmitted and received signals.

If bit latching is enabled (BIT\_LATCHING = 1), TxE\_BRx will remain set until the register has been read, after which it is reset if no mismatch is found between transmitted and received signals or the branch leaves Branch\_Normal. If bit latching is not enabled, TxE\_BRx is reset if no mismatch is found in a data frame or the branch leaves Branch\_Normal.

**CLAMP\_BRx:**

CLAMP\_BRx is set when a branch is clamped for longer than  $t_{\text{detCL}(\text{bus})}$ , generating a CLAMP\_ERROR interrupt along with an EVENT\_BRx interrupt to indicate the branch.

If bit latching is enabled (BIT\_LATCHING = 1), CLAMP\_BRx will remain set until the register has been read, after which it is reset when idle is detected on the branch. If bit latching is not enabled, CLAMP\_BRx is reset when idle is detected on the branch.



## 7. Limiting values

**Table 12. Limiting values**

In accordance with the Absolute Maximum Rating System (IEC 60134). All voltages are referenced to GND.

Symbol	Parameter	Conditions	Min	Max	Unit	
V <sub>CC</sub>	supply voltage	no time limit	-0.3	+5.5	V	
V <sub>BAT</sub>	battery supply voltage	no time limit	-0.3	+48	V	
		during load dump (400 ms max.)	-0.3	+60	V	
V <sub>BUF</sub>	supply voltage on pin V <sub>BUF</sub>	no time limit	-0.3	+5.5	V	
V <sub>IO</sub>	supply voltage on pin V <sub>IO</sub>	no time limit	-0.3	+5.5	V	
V <sub>INH</sub>	voltage on pin INH	no time limit	-0.3	V <sub>BAT</sub> + 0.3	V	
I <sub>INH</sub>	current on pin INH	AS_Normal, AS_Standby or AS_Reset no time limit	-1	0	mA	
V <sub>LWU</sub>	voltage on pin LWU	no time limit	-0.3	V <sub>BAT</sub> + 0.3	V	
V <sub>TRXD0</sub>	voltage on pin TRXD0	no time limit	-0.3	+5.5	V	
V <sub>TRXD1</sub>	voltage on pin TRXD1	no time limit	-0.3	+5.5	V	
V <sub>BGE</sub>	voltage on pin BGE	no time limit	-0.3	+5.5	V	
V <sub>TXD</sub>	voltage on pin TXD	no time limit	-0.3	+5.5	V	
V <sub>TXEN</sub>	voltage on pin TXEN	no time limit	-0.3	+5.5	V	
V <sub>RXD</sub>	voltage on pin RXD	no time limit	-0.3	min(V <sub>IO</sub> + 0.3, 5.5)	V	
V <sub>RSTN</sub>	voltage on pin RSTN	no time limit	-0.3	+5.5	V	
V <sub>INTN</sub>	voltage on pin INTN	no time limit	-0.3	+5.5	V	
V <sub>SCSN</sub>	voltage on pin SCSN	no time limit	-0.3	+5.5	V	
V <sub>SCLK</sub>	voltage on pin SCLK	no time limit	-0.3	+5.5	V	
V <sub>SDI</sub>	voltage on pin SDI	no time limit	-0.3	+5.5	V	
V <sub>SDO</sub>	voltage on pin SDO	no time limit	-0.3	+5.5	V	
V <sub>BP</sub>	voltage on pin BP	on any BP pin with respect to other BP/BM pins and GND; no time limit	-60	+60	V	
V <sub>BM</sub>	voltage on pin BM	on any BM pin with respect to other BP/BM pins and GND; no time limit	-60	+60	V	
I <sub>O(LWU)</sub>	output current on pin LWU	no time limit	-15	-	mA	
V <sub>tt</sub>	transient voltage	on pins LWU, V <sub>BAT</sub> , BP and BM	[1]	-100	-	V
			[2]	-	75	V
			[3]	-150	-	V
			[4]	-	100	V
T <sub>amb</sub>	ambient temperature		-40	+125	°C	
T <sub>vj</sub>	virtual junction temperature		[5]	-40	+150	°C
T <sub>stg</sub>	storage temperature		-55	+150	°C	

**Table 12. Limiting values ...continued**

In accordance with the Absolute Maximum Rating System (IEC 60134). All voltages are referenced to GND.

Symbol	Parameter	Conditions	Min	Max	Unit	
V <sub>ESD</sub>	electrostatic discharge voltage	IEC61000-4-2 on pins BP and BM to GND	[6]	-6.0	+6.0	kV
		IEC61000-4-2 on pin LWU to GND	[6][10]	-6.0	+6.0	kV
		IEC61000-4-2 on pin V <sub>BAT</sub> to GND	[6][11]	-6.0	+6.0	kV
		HBM on pins BP and BM to GND	[7]	-8.0	+8.0	kV
		HBM on pins LWU and V <sub>BAT</sub> to GND	[7][12]	-6.0	+6.0	kV
		HBM on any other pin	[7]	-4.0	+4.0	kV
		MM on all pins	[8]	-200	+200	kV
		CDM on all pins	[9]	-1000	+1000	kV

[1] According to ISO7637, test pulse 1, class C; verified by an external test house.

[2] According to ISO7637, test pulse 2a, class C; verified by an external test house.

[3] According to ISO7637, test pulse 3a, class C; verified by an external test house.

[4] According to ISO7637, test pulse 3b, class C; verified by an external test house.

[5] In accordance with IEC 60747-1. An alternative definition of T<sub>vj</sub> is:  $T_{vj} = T_{amb} + P \times R_{th(j-a)}$ , where R<sub>th(j-a)</sub> is a fixed value used in the calculation of T<sub>vj</sub>. The rating for T<sub>vj</sub> limits the allowable combinations of power dissipation (P) and ambient temperature (T<sub>amb</sub>).

[6] IEC61000-4-2: C = 150 pF; R = 330 Ω; verified by an external test house. The test result is equal to or better than ±6 kV (unaided).

[7] HBM: with respect to GND (and to each other); C = 100 pF; R = 1.5 kΩ;

[8] MM: C = 200 pF; L = 0.75 μH; R = 10 Ω.

[9] CDM: R = 1 Ω.

[10] With 3.3 kΩ in series.

[11] With 100 nF from V<sub>BAT</sub> to GND.

[12] Guaranteed only when all n.c. pins are connected to GND.

## 8. Thermal characteristics

**Table 13. Thermal characteristics**

Symbol	Parameter	Conditions	Typ	Unit
R <sub>th(j-a)</sub>	thermal resistance from junction to ambient	[1] in free air	24	K/W
R <sub>th(j-c)</sub>	thermal resistance from junction to case	in free air	2.5	K/W

[1] TJA1085 mounted on a JEDEC 2s2p board with 36 vias between layer 1 and layer 2; via diameter: 0.5 mm, wall thickness: 18 μm.

## 9. Static characteristics

**Table 14. Static characteristics**

All parameters are guaranteed for  $V_{BAT} = 4.45\text{ V to }60\text{ V}$ ;  $V_{CC} = 4.45\text{ V to }5.25\text{ V}$ ;  $V_{BUF} = 4.45\text{ V to }5.25\text{ V}$ ;  $V_{IO} = 2.55\text{ V to }5.25\text{ V}$ ;  $T_{vj} = -40\text{ }^{\circ}\text{C to }+150\text{ }^{\circ}\text{C}$ ;  $C_{bus} = 100\text{ pF}$ ;  $R_{bus} = 40\text{ }\Omega\text{ to }55\text{ }\Omega$ ;  $C_{RXD} = 15\text{ pF}$  and  $C_{TRXD0} = C_{TRXD1} = 50\text{ pF}$  unless otherwise specified. All voltages are defined with respect to ground; positive currents flow into the IC.

Symbol	Parameter	Conditions	Min	Typ	Max	Unit
<b>Power-on reset for <math>V_{DIG}</math></b>						
$V_{th(det)POR}$	power-on reset detection threshold voltage	of internal digital circuitry	3	-	3.4	V
$V_{th(rec)POR}$	power-on reset recovery threshold voltage	of internal digital circuitry	3.1	-	3.5	V
$V_{hys(POR)}$	power-on reset hysteresis voltage	of internal digital circuitry	100	-	500	mV
$\Delta V_{(VCC-VDIG)}$	voltage difference between $V_{CC}$ and $V_{DIG}$	$V_{CC} = 4.45\text{ V}$ ; $V_{BAT} = V_{BUF} = 0\text{ V}$	-	-	1.0	V
$\Delta V_{(VBAT-VDIG)}$	voltage difference between $V_{BAT}$ and $V_{DIG}$	$V_{BAT} = 4.45\text{ V}$ ; $V_{CC} = V_{BUF} = 0\text{ V}$	-	-	1.0	V
$\Delta V_{(VBUF-VDIG)}$	voltage difference between $V_{BUF}$ and $V_{DIG}$	$V_{BUF} = 4.45\text{ V}$ ; $V_{CC} = V_{BAT} = 0\text{ V}$	-	-	1.0	V
<b>Supply: pin <math>V_{BAT}</math></b>						
$V_{BAT}$	battery supply voltage	operating range	4.75	-	60	V
$I_{BAT}$	battery supply current	AS_Normal; no load on INH	-	0.1	1	mA
		AS_Standby; no load on INH; wake-up enabled on all branches	-	50	100	$\mu\text{A}$
		AS_Sleep; wake-up enabled on all branches	-	50	100	$\mu\text{A}$
		AS_Sleep; wake-up enabled on all branches; $T_{vj} \leq 85\text{ }^{\circ}\text{C}$	-	50	90	$\mu\text{A}$
		AS_Sleep; wake-up disabled on all branches	-	25	55	$\mu\text{A}$
		AS_Sleep; wake-up disabled on all branches; $T_{vj} \leq 85\text{ }^{\circ}\text{C}$	-	25	45	$\mu\text{A}$
$V_{uvd}$	undervoltage detection voltage		4.45	-	4.715	V
$V_{uvr}$	undervoltage recovery voltage		4.475	-	4.74	V
$V_{uvhys}$	undervoltage hysteresis voltage		25	-	290	mV
<b>Supply: pins <math>V_{CC1}</math> and <math>V_{CC2}</math> (connected on the PCB)</b>						
$V_{CC}$	supply voltage	operating range	4.75	-	5.25	V

**Table 14. Static characteristics ...continued**

All parameters are guaranteed for  $V_{BAT} = 4.45\text{ V to }60\text{ V}$ ;  $V_{CC} = 4.45\text{ V to }5.25\text{ V}$ ;  $V_{BUF} = 4.45\text{ V to }5.25\text{ V}$ ;  $V_{IO} = 2.55\text{ V to }5.25\text{ V}$ ;  $T_{vj} = -40\text{ °C to }+150\text{ °C}$ ;  $C_{bus} = 100\text{ pF}$ ;  $R_{bus} = 40\text{ }\Omega\text{ to }55\text{ }\Omega$ ;  $C_{RXD} = 15\text{ pF}$  and  $C_{TRXD0} = C_{TRXD1} = 50\text{ pF}$  unless otherwise specified. All voltages are defined with respect to ground; positive currents flow into the IC.

Symbol	Parameter	Conditions	Min	Typ	Max	Unit
$I_{CC}$	supply current	AS_Normal; $V_{TXEN} = 0\text{ V}$ ; $V_{BGE} = V_{IO}$ ; $R_{bus} = 45\text{ }\Omega$ ; all branches in Branch_Normal	[1] -	180	240	mA
		AS_Normal; $V_{TXEN} = V_{IO}$ ; $V_{BGE} = 0\text{ V}$ ; $R_{bus} = 45\text{ }\Omega$ ; all branches in Branch_Normal and/or Branch_Disabled	[1] -	-	80	mA
		AS_Standby	[1][2] -	4	35	$\mu\text{A}$
		AS_Standby; $T_{vj} \leq 85\text{ °C}$	[1][2] -	4	15	$\mu\text{A}$
		AS_Sleep, AS_Reset	[1][2] -	0	30	$\mu\text{A}$
		AS_Sleep, AS_Reset; $T_{vj} \leq 85\text{ °C}$	[1][2] -	0	10	$\mu\text{A}$
$V_{uvd}$	undervoltage detection voltage		4.45	-	4.715	V
$V_{uvr}$	undervoltage recovery voltage		4.475	-	4.74	V
$V_{uvhys}$	undervoltage hysteresis voltage		25	-	290	mV
<b>Supply: pins <math>V_{BUF1}</math> and <math>V_{BUF2}</math> (connected on the PCB)</b>						
$V_{BUF}$	supply voltage on pin $V_{BUF}$	$5.5\text{ V} \leq V_{BAT} \leq 60\text{ V}$ ; $V_{CC} \leq V_{uvd}(V_{CC})$	4.5	-	5.25	V
		$4.5\text{ V} \leq V_{BAT} \leq 5.5\text{ V}$ ; $V_{CC} \leq V_{uvd}(V_{CC})$	3.5	-	5.25	V
$\Delta V_{(V_{CC}-V_{BUF})}$	voltage difference between $V_{CC}$ and $V_{BUF}$	$V_{CC} \geq V_{uvr}(V_{CC})$	0	-	0.25	V
$I_{ch}(V_{BAT}-V_{BUF})$	charge current from $V_{BAT}$ to $V_{BUF}$	$5.5\text{ V} \leq V_{BAT} \leq 60\text{ V}$ ; $V_{CC} \leq V_{uvd}(V_{CC})$ ; $0\text{ V} \leq V_{BUF} \leq 4\text{ V}$	-200	-100	-30	$\mu\text{A}$
$V_{uvd}$	undervoltage detection voltage		4.2	-	4.474	V
$V_{uvr}$	undervoltage recovery voltage		4.225	-	4.499	V
$V_{uvhys}$	undervoltage hysteresis voltage		25	-	299	mV
<b>Supply: pin <math>V_{IO}</math></b>						
$V_{IO}$	supply voltage on pin $V_{IO}$	operating range	2.8	-	5.25	V
$I_{IO}$	supply current on pin $V_{IO}$	AS_Normal; $V_{TXD} = V_{IO}$	-	-	1000	$\mu\text{A}$
		AS_Standby; AS_Sleep; AS_PowerOff; $V_{SCSN} = V_{TXEN} = V_{RSTN} = V_{VIO}$	-	2	7	$\mu\text{A}$
$I_r$	reverse current	from digital input pin to $V_{IO}$ ; AS_PowerOff; $V_{TXEN} = V_{TXD} = V_{BGE} = V_{SCSN} =$ $V_{SCLK} = V_{SDI} = V_{RSTN} = 5.25\text{ V}$ ; $V_{CC} = V_{IO} = 0\text{ V}$	-5	-	+5	$\mu\text{A}$

**Table 14. Static characteristics ...continued**

All parameters are guaranteed for  $V_{BAT} = 4.45\text{ V to }60\text{ V}$ ;  $V_{CC} = 4.45\text{ V to }5.25\text{ V}$ ;  $V_{BUF} = 4.45\text{ V to }5.25\text{ V}$ ;  $V_{IO} = 2.55\text{ V to }5.25\text{ V}$ ;  $T_{vj} = -40\text{ }^{\circ}\text{C to }+150\text{ }^{\circ}\text{C}$ ;  $C_{bus} = 100\text{ pF}$ ;  $R_{bus} = 40\text{ }\Omega\text{ to }55\text{ }\Omega$ ;  $C_{RXD} = 15\text{ pF}$  and  $C_{TRXD0} = C_{TRXD1} = 50\text{ pF}$  unless otherwise specified. All voltages are defined with respect to ground; positive currents flow into the IC.

Symbol	Parameter	Conditions	Min	Typ	Max	Unit
$V_{uvd}$	undervoltage detection voltage		2.55	-	2.765	V
$V_{uvr}$	undervoltage recovery voltage		2.575	-	2.79	V
$V_{uvhys}$	undervoltage hysteresis voltage		25	-	240	mV
<b>Pin TXEN</b>						
$V_{IH}$	HIGH-level input voltage	AS_Normal	$0.7V_{IO}$	-	5.5	V
$V_{IL}$	LOW-level input voltage	AS_Normal	-0.3	-	$0.3V_{IO}$	V
$I_{IH}$	HIGH-level input current	$V_{TXEN} = V_{IO}$	-2	-	+2	$\mu\text{A}$
$I_{IL}$	LOW-level input current	$V_{TXEN} = 0.3V_{IO}$	-300	-	-50	$\mu\text{A}$
<b>Pin TXD</b>						
$V_{IH}$	HIGH-level input voltage	AS_Normal	$0.6V_{IO}$	-	5.5	V
$V_{IL}$	LOW-level input voltage	AS_Normal	-0.3	-	$0.4V_{IO}$	V
$R_{pd}$	pull-down resistance	to GND	50	150	400	k $\Omega$
$C_i$	input capacitance	with respect to all other pins at ground; $V_{TXD} = 100\text{ mV}$ ; $f = 5\text{ MHz}$	<a href="#">3</a> -	-	10	pF
<b>Pin BGE</b>						
$V_{IH}$	HIGH-level input voltage	AS_Normal	$0.7V_{IO}$	-	5.5	V
$V_{IL}$	LOW-level input voltage	AS_Normal	-0.3	-	$0.3V_{IO}$	V
$R_{pd}$	pull-down resistance	to GND	50	150	400	k $\Omega$
<b>Pin RXD</b>						
$I_{OH}$	HIGH-level output current	$V_{RXD} = V_{IO} - 0.4\text{ V}$	-15	-	-1	mA
$I_{OL}$	LOW-level output current	$V_{RXD} = 0.4\text{ V}$	1	-	15	mA
$V_{OH}$	HIGH-level output voltage	$I_{OH(RXD)} = -1\text{ mA}$	$V_{IO}$ -0.4	-	$V_{IO}$	V
$V_{OL}$	LOW-level output voltage	$I_{OL(RXD)} = 1\text{ mA}$	-	-	0.4	V
$V_O$	output voltage	when undervoltage on $V_{IO}$ ; $V_{CC} \geq 4.75\text{ V}$ ; $R_L = 100\text{ k}\Omega$ to GND	-	-	500	mV
		$V_{CC} = V_{BAT} = V_{BUF} = 0\text{ V}$ ; $R_L = 100\text{ k}\Omega$ to $V_{IO}$	$V_{IO}$ -500	-	$V_{IO}$	mV
<b>Pin RSTN</b>						
$V_{IH}$	HIGH-level input voltage		$0.7V_{IO}$	-	5.5	V
$V_{IL}$	LOW-level input voltage		-0.3	-	$0.3V_{IO}$	V
$I_{IH}$	HIGH-level input current	$V_{RSTN} = V_{IO}$	-1	-	+1	$\mu\text{A}$
$I_{IL}$	LOW-level input current	$V_{RSTN} = 0.3V_{IO}$	-300	-	-30	$\mu\text{A}$
<b>Pins TRXD0 and TRXD1</b>						
$V_{IH}$	HIGH-level input voltage		$0.7V_{BUF}$	-	5.5	V
$V_{IL}$	LOW-level input voltage		-0.3	-	$0.3V_{BUF}$	V
$V_{OL}$	LOW-level output voltage	$R_{pu} = 200\text{ }\Omega$	-0.3	-	+0.8	V

**Table 14. Static characteristics ...continued**

All parameters are guaranteed for  $V_{BAT} = 4.45\text{ V to }60\text{ V}$ ;  $V_{CC} = 4.45\text{ V to }5.25\text{ V}$ ;  $V_{BUF} = 4.45\text{ V to }5.25\text{ V}$ ;  $V_{IO} = 2.55\text{ V to }5.25\text{ V}$ ;  $T_{vj} = -40\text{ }^{\circ}\text{C to }+150\text{ }^{\circ}\text{C}$ ;  $C_{bus} = 100\text{ pF}$ ;  $R_{bus} = 40\text{ }\Omega\text{ to }55\text{ }\Omega$ ;  $C_{RXD} = 15\text{ pF}$  and  $C_{TRXD0} = C_{TRXD1} = 50\text{ pF}$  unless otherwise specified. All voltages are defined with respect to ground; positive currents flow into the IC.

Symbol	Parameter	Conditions	Min	Typ	Max	Unit
$C_i$	input capacitance	with respect to all other pins at GND; $V_{TXD} = 100\text{ mV}$ ; $f = 5\text{ MHz}$	[3] -	-	15	pF
$R_{pu}$	pull-up resistance	to $V_{BUF}$	2.5	5	10	k $\Omega$
<b>Pins BP and BM</b>						
$V_{IH(dif)}$	differential HIGH-level input voltage	AS_Normal; $-10\text{ V} \leq V_{cm} \leq +15\text{ V}$	[4] 150	-	300	mV
$V_{iL(dif)}$	differential LOW-level input voltage	AS_Normal; $-10\text{ V} \leq V_{cm} \leq +15\text{ V}$	[4] -300	-	-150	mV
		AS_Standby; AS_Sleep; $-10\text{ V} \leq V_{cm} \leq +15\text{ V}$	[4] -400	-	-125	mV
$\Delta V_{i(dif)(H-L)}$	differential input voltage difference between HIGH-level and LOW-level	$V_{cm} = 2.5\text{ V}$ ; AS_Normal	[4] -30	-	+30	mV
$V_{OH(dif)}$	differential HIGH-level output voltage	$4.75\text{ V} \leq V_{BUF} \leq 5.25\text{ V}$	900	-	2000	mV
		$4.45\text{ V} \leq V_{BUF} \leq 5.25\text{ V}$	700	-	2000	mV
$V_{OL(dif)}$	differential LOW-level output voltage	$4.75\text{ V} \leq V_{BUF} \leq 5.25\text{ V}$	-2000	-	-900	mV
		$4.45\text{ V} \leq V_{BUF} \leq 5.25\text{ V}$	-2000	-	-700	mV
$V_{o(idle)(BP)}$	idle output voltage on pin BP	Branch_Normal	$0.4V_{BUF}$	-	$0.6V_{BUF}$	V
		Branch_LowPower	-0.1	-	+0.1	V
$V_{o(idle)(BM)}$	idle output voltage on pin BM	Branch_Normal	$0.4V_{BUF}$	-	$0.6V_{BUF}$	V
		Branch_LowPower	-0.1	-	+0.1	V
$I_{o(idle)BP}$	idle output current on pin BP	$-60\text{ V} \leq V_{BP} \leq +60\text{ V}$ ; no bus load	-7.5	-	+7.5	mA
$I_{o(idle)BM}$	idle output current on pin BM	$-60\text{ V} \leq V_{BM} \leq +60\text{ V}$ ; no bus load	-7.5	-	+7.5	mA
$V_{o(idle)(dif)}$	differential idle output voltage		-25	0	+25	mV
$ V_{i(dif)det(act)} $	activity detection differential input voltage (absolute value)	AS_Normal; $-10\text{ V} \leq V_{cm} \leq +15\text{ V}$	[4] 150	-	300	mV
$V_{cm(bus)(DATA_0)}$	DATA_0 bus common-mode voltage	Branch_Transmit	$0.4V_{BUF}$	-	$0.65 \times V_{BUF}$	V
$V_{cm(bus)(DATA_1)}$	DATA_1 bus common-mode voltage	Branch_Transmit	$0.4V_{BUF}$	-	$0.65 \times V_{BUF}$	V
$R_i$	input resistance	$R_{bus} = \infty\text{ }\Omega$	10	20	40	k $\Omega$
$R_{i(dif)(BP-BM)}$	differential input resistance between pin BP and pin BM	$R_{bus} = \infty\text{ }\Omega$	20	40	80	k $\Omega$
$Z_{o(eq)TX}$	transmitter equivalent output impedance	$C_{bus} = 100\text{ pF}$ ; $R_{bus} = 40\text{ }\Omega$ or $100\text{ }\Omega$	[5] 10	-	600	$\Omega$
$C_{i(BP)}$	input capacitance on pin BP	with respect to all other pins at GND; $V_{BP} = 100\text{ mV}$ ; $f = 5\text{ MHz}$	[3] -	-	15	pF
$C_{i(BM)}$	input capacitance on pin BM	with respect to all other pins at GND; $V_{BM} = 100\text{ mV}$ ; $f = 5\text{ MHz}$	[3] -	-	15	pF
$C_{i(dif)(BP-BM)}$	differential input capacitance between pin BP and pin BM	$V_{BP} = 100\text{ mV}$ ; $V_{BM} = 100\text{ mV}$ ; $f = 5\text{ MHz}$	[3] -	-	5	pF

**Table 14. Static characteristics ...continued**

All parameters are guaranteed for  $V_{BAT} = 4.45\text{ V}$  to  $60\text{ V}$ ;  $V_{CC} = 4.45\text{ V}$  to  $5.25\text{ V}$ ;  $V_{BUF} = 4.45\text{ V}$  to  $5.25\text{ V}$ ;  $V_{IO} = 2.55\text{ V}$  to  $5.25\text{ V}$ ;  $T_{vj} = -40\text{ }^{\circ}\text{C}$  to  $+150\text{ }^{\circ}\text{C}$ ;  $C_{bus} = 100\text{ pF}$ ;  $R_{bus} = 40\text{ }\Omega$  to  $55\text{ }\Omega$ ;  $C_{RXD} = 15\text{ pF}$  and  $C_{TRXD0} = C_{TRXD1} = 50\text{ pF}$  unless otherwise specified. All voltages are defined with respect to ground; positive currents flow into the IC.

Symbol	Parameter	Conditions	Min	Typ	Max	Unit
$I_{L(BP)}$	input leakage current on pin BP	AS_PowerOff; $V_{BP} = V_{BM}$ ; $0\text{ V} \leq V_{BP} \leq 5\text{ V}$	-5	0	+5	$\mu\text{A}$
		loss of ground; $V_{BP} = V_{BM} = 0\text{ V}$ ; all other pins connected to $16\text{ V}$ via $0\text{ }\Omega$	[3] -1600	-	+1600	$\mu\text{A}$
$I_{L(BM)}$	input leakage current on pin BM	AS_PowerOff; $V_{BP} = V_{BM}$ ; $0\text{ V} \leq V_{BM} \leq 5\text{ V}$	-5	0	+5	$\mu\text{A}$
		loss of ground; $V_{BP} = V_{BM} = 0\text{ V}$ ; all other pins connected to $16\text{ V}$ via $0\text{ }\Omega$	[3] -1600	-	+1600	$\mu\text{A}$
$ I_{O(sc)} $	short-circuit output current (absolute value)	on pin BP; $-5\text{ V} \leq V_{BP} \leq +60\text{ V}$ ; $R_{sc} \leq 1\text{ }\Omega$ ; $t_{sc} \geq 1500\text{ }\mu\text{s}$	[6][8] -	-	72	$\text{mA}$
		on pin BP; $-5\text{ V} \leq V_{BP} \leq +27\text{ V}$ ; $R_{sc} \leq 1\text{ }\Omega$ ; $t_{sc} \geq 1500\text{ }\mu\text{s}$	[6][8] -	-	60	$\text{mA}$
		on pin BM; $-5\text{ V} \leq V_{BM} \leq +60\text{ V}$ ; $R_{sc} \leq 1\text{ }\Omega$ ; $t_{sc} \geq 1500\text{ }\mu\text{s}$	[6][8] -	-	72	$\text{mA}$
		on pin BM; $-5\text{ V} \leq V_{BM} \leq +27\text{ V}$ ; $R_{sc} \leq 1\text{ }\Omega$ ; $t_{sc} \geq 1500\text{ }\mu\text{s}$	[6][8] -	-	60	$\text{mA}$
		on pins BP and BM; $V_{BP} = V_{BM}$ ; $R_{sc} \leq 1\text{ }\Omega$ ; $t_{sc} \geq 1500\text{ }\mu\text{s}$	[7][8] -	-	60	$\text{mA}$
<b>Pin INH</b>						
$V_{OH}$	HIGH-level output voltage	$I_{INH} = -0.2\text{ mA}$ ; AS_Normal; AS_Standby; AS_Reset	$V_{BAT} - 0.8$	-	$V_{BAT}$	$\text{V}$
$I_L$	leakage current	AS_Sleep; AS_PowerOff	-3	-	+3	$\mu\text{A}$
$I_{O(sc)}$	short-circuit output current	$V_{INH} = 0\text{ V}$ ; AS_Normal; AS_Standby; AS_Reset	-7	-	-1	$\text{mA}$
<b>Pin LWU</b>						
$V_{th(wake)LWU}$	wake-up threshold voltage on pin LWU	AS_Sleep; AS_Standby	2	-	3.75	$\text{V}$
$V_{hys(wake)LWU}$	wake-up hysteresis voltage on pin LWU		0.3	-	1.2	$\text{V}$
$I_{IL}$	LOW-level input current	$V_{LWU} = 2\text{ V}$ for $t > t_{det(wake)(LWU)}$	3	-	11	$\mu\text{A}$
		$V_{LWU} = 0\text{ V}$	-2	-	-0.3	$\mu\text{A}$
$I_{IH}$	HIGH-level input current	$V_{LWU} = 3.75\text{ V}$ for $t > t_{det(wake)(LWU)}$ ; $4.75\text{ V} \leq V_{BAT} \leq +60\text{ V}$	-11	-	-3	$\mu\text{A}$
		$V_{LWU} = V_{BAT}$	0.2	-	1.2	$\mu\text{A}$
<b>Pin SDO</b>						
$V_{OH}$	HIGH-level output voltage	$I_{OH(SDO)} = -0.5\text{ mA}$	$V_{IO} - 0.4$	-	$V_{IO}$	$\text{V}$
$V_{OL}$	LOW-level output voltage	$I_{OL(SDO)} = 0.5\text{ mA}$	-	-	0.4	$\text{V}$
$I_{OH}$	HIGH-level output current	$V_{SDO} = V_{IO} - 0.4\text{ V}$	-8	-2	-0.5	$\text{mA}$
$I_{OL}$	LOW-level output current	$V_{SDO} = 0.4\text{ V}$	0.5	2	8	$\text{mA}$
$I_L$	leakage current	SCSN HIGH	-5	-	+5	$\mu\text{A}$

**Table 14. Static characteristics ...continued**

All parameters are guaranteed for  $V_{BAT} = 4.45\text{ V to }60\text{ V}$ ;  $V_{CC} = 4.45\text{ V to }5.25\text{ V}$ ;  $V_{BUF} = 4.45\text{ V to }5.25\text{ V}$ ;  $V_{IO} = 2.55\text{ V to }5.25\text{ V}$ ;  $T_{vj} = -40\text{ }^{\circ}\text{C to }+150\text{ }^{\circ}\text{C}$ ;  $C_{bus} = 100\text{ pF}$ ;  $R_{bus} = 40\text{ }\Omega\text{ to }55\text{ }\Omega$ ;  $C_{RXD} = 15\text{ pF}$  and  $C_{TRXD0} = C_{TRXD1} = 50\text{ pF}$  unless otherwise specified. All voltages are defined with respect to ground; positive currents flow into the IC.

Symbol	Parameter	Conditions	Min	Typ	Max	Unit
$V_O$	output voltage	when undervoltage on $V_{IO}$ ; $V_{CC} \geq 4.75\text{ V}$ ; $R_L = 100\text{ k}\Omega$ to GND	-	-	500	mV
		$V_{CC} = V_{BAT} = V_{BUF} = 0\text{ V}$ ; $R_L = 100\text{ k}\Omega$ to GND	-	-	500	mV
<b>Pin SDI</b>						
$V_{IH}$	HIGH-level input voltage		$0.7V_{IO}$	-	5.5	V
$V_{IL}$	LOW-level input voltage		-0.3	-	$0.3V_{IO}$	V
$R_{pd}$	pull-down resistance	to GND	50	150	400	k $\Omega$
<b>Pin SCSN</b>						
$V_{IH}$	HIGH-level input voltage		$0.7V_{IO}$	-	5.5	V
$V_{IL}$	LOW-level input voltage		-0.3	-	$0.3V_{IO}$	V
$I_{IH}$	HIGH-level input current	$V_{SCSN} = V_{IO}$	-1	-	+1	$\mu\text{A}$
$I_{IL}$	LOW-level input current	$V_{SCSN} = 0.3V_{IO}$	-15	-	-3	$\mu\text{A}$
<b>Pin SCLK</b>						
$V_{IH}$	HIGH-level input voltage		$0.7V_{IO}$	-	5.5	V
$V_{IL}$	LOW-level input voltage		-0.3	-	$0.3V_{IO}$	V
$R_{pd}$	pull-down resistance	to GND	50	150	400	k $\Omega$
<b>Pin INTN</b>						
$V_{OL}$	LOW-level output voltage	$I_{OL(INTN)} = 0.5\text{ mA}$	-	-	0.4	V
$V_O$	output voltage	when undervoltage on $V_{IO}$ ; $V_{CC} \geq 4.75\text{ V}$ ; $R_L = 100\text{ k}\Omega$ to GND	-	-	500	mV
		$V_{CC} = V_{BAT} = V_{BUF} = 0\text{ V}$ ; $R_L = 100\text{ k}\Omega$ to GND	-	-	500	mV
<b>Temperature protection</b>						
$T_{j(warn)}$	warning junction temperature		155	-	190	$^{\circ}\text{C}$
$T_{j(high)}$	high junction temperature		165	-	200	$^{\circ}\text{C}$
$\Delta T_{j(high-warn)}$	difference between high and warning junction temperature		10	-	45	$^{\circ}\text{C}$

- [1] Specified current is the sum of currents  $I_{CC1}$  and  $I_{CC2}$ .
- [2] These values are guaranteed under the condition that the internal digital block is supplied from  $V_{BAT}$ .
- [3] Guaranteed by design.
- [4]  $V_{cm}$  is the BP/BM common mode voltage.
- [5]  $Z_{O(eq)(TX)} = 50\text{ }\Omega \times (V_{bus(100)} - V_{bus(40)}) / (2.5 \times V_{bus(40)} - V_{bus(100)})$  where:
  - $V_{bus(100)}$  is the differential output voltage on a load of  $100\text{ }\Omega$  and  $100\text{ pF}$  in parallel
  - $V_{bus(40)}$  is the differential output voltage on a load of  $40\text{ }\Omega$  and  $100\text{ pF}$  in parallel when driving a DATA\_1.
- [6]  $R_{sc}$  is the short-circuit resistance; voltage difference between bus pins BP and BM is  $60\text{ V max}$ .
- [7]  $R_{sc}$  is the short-circuit resistance between BP and BM.
- [8]  $t_{sc}$  is the minimum duration of the short-circuit



## 10. Dynamic characteristics

**Table 15. Dynamic characteristics**

All parameters are guaranteed for  $V_{BAT} = 4.45\text{ V to }60\text{ V}$ ;  $V_{CC} = 4.45\text{ V to }5.25\text{ V}$ ;  $V_{BUF} = 4.45\text{ V to }5.25\text{ V}$ ;  $V_{IO} = 2.55\text{ V to }5.25\text{ V}$ ;  $T_{vj} = -40\text{ }^{\circ}\text{C to }+150\text{ }^{\circ}\text{C}$ ;  $R_{bus} = 40\ \Omega$ ,  $C_{bus} = 100\text{ pF}$ ;  $C_{RXD} = 15\text{ pF}$ ;  $C_{TRXD0} = C_{TRXD1} = 50\text{ pF}$  and  $C_{SDO} = 50\text{ pF}$  unless otherwise specified. All voltages are defined with respect to ground; positive currents flow into the IC.

Symbol	Parameter	Conditions	Min	Typ	Max	Unit
<b>Undervoltage detection</b>						
$t_{det(uv)(VBAT)}$	undervoltage detection time on pin $V_{BAT}$	$V_{BAT} = 4.35\text{ V}$	5	-	150	$\mu\text{s}$
$t_{rec(uv)(VBAT)}$	undervoltage recovery time on pin $V_{BAT}$	$V_{BAT} = 4.85\text{ V}$	5	-	150	$\mu\text{s}$
$t_{det(uv)(VCC)}$	undervoltage detection time on pin $V_{CC}$	$V_{CC} = 4.35\text{ V}$	5	-	100	$\mu\text{s}$
$t_{rec(uv)(VCC)}$	undervoltage recovery time on pin $V_{CC}$	$V_{CC} = 4.85\text{ V}$	5	-	100	$\mu\text{s}$
$t_{det(uv)(VBUF)}$	undervoltage detection time on pin $V_{BUF}$	$V_{BUF} = 4.10\text{ V}$	5	-	100	$\mu\text{s}$
$t_{rec(uv)(VBUF)}$	undervoltage recovery time on pin $V_{BUF}$	$V_{BUF} = 4.6\text{ V}$	5	-	100	$\mu\text{s}$
$t_{det(uv)(VIO)}$	undervoltage detection time on pin $V_{IO}$	$V_{IO} = 2.45\text{ V}$	5	-	100	$\mu\text{s}$
$t_{rec(uv)(VIO)}$	undervoltage recovery time on pin $V_{IO}$	$V_{IO} = 2.9\text{ V}$	5	-	100	$\mu\text{s}$
$t_{to(ugd)(VCC)}$	undervoltage detection time-out time on pin $V_{CC}$		100	-	670	ms
$t_{to(ugd)(VIO)}$	undervoltage detection time-out time on pin $V_{IO}$		100	-	670	ms
$t_{to(ugvr)(VCC)}$	undervoltage recovery time-out time on pin $V_{CC}$		1	-	5	ms
$t_{to(ugvr)(VIO)}$	undervoltage recovery time-out time on pin $V_{IO}$		1	-	5	ms
<b>SPI</b>						
$t_{cy}(clk)$	clock cycle time		0.5	-	100	$\mu\text{s}$
$t_{SPILEAD}$	SPI enable lead time		250	-	-	ns
$t_{SPILAG}$	SPI enable lag time		250	-	-	ns
$t_{su}(D)$	data input set-up time		150	-	-	ns
$t_{h}(D)$	data input hold time		100	-	-	ns
$t_{d}(SCLK-SDO)$	delay time from SCLK to SDO		-	-	200	ns
$t_{WH}(S)$	chip select pulse width HIGH		10	-	-	$\mu\text{s}$
$t_{d}(SCSNHL-SDOL)$	SCSN falling edge to SDO LOW-level delay time		-	-	250	ns
$t_{d}(SCSNLH-SDOZ)$	SCSN rising edge to SDO three-state delay time		-	-	500	ns

**Table 15. Dynamic characteristics ...continued**

All parameters are guaranteed for  $V_{BAT} = 4.45\text{ V to }60\text{ V}$ ;  $V_{CC} = 4.45\text{ V to }5.25\text{ V}$ ;  $V_{BUF} = 4.45\text{ V to }5.25\text{ V}$ ;  $V_{IO} = 2.55\text{ V to }5.25\text{ V}$ ;  $T_{vj} = -40\text{ }^{\circ}\text{C to }+150\text{ }^{\circ}\text{C}$ ;  $R_{bus} = 40\ \Omega$ ,  $C_{bus} = 100\text{ pF}$ ;  $C_{RXD} = 15\text{ pF}$ ;  $C_{TRXD0} = C_{TRXD1} = 50\text{ pF}$  and  $C_{SDO} = 50\text{ pF}$  unless otherwise specified. All voltages are defined with respect to ground; positive currents flow into the IC.

Symbol	Parameter	Conditions	Min	Typ	Max	Unit
<b>Transmit path</b>						
$t_{d(\text{TXD-bus})}$	delay time from TXD to bus	AS_Normal; see <a href="#">Figure 10</a>	<a href="#">[1]</a>			
		DATA_0	-	-	75	ns
		DATA_1	-	-	75	ns
$\Delta t_{d(\text{TXD-bus})}$	delay time difference from TXD to bus	between DATA_0 and DATA_1; AS_Normal	<a href="#">[1]</a> <a href="#">[2]</a>	-5	+5	ns
$t_{d(\text{TXD-TRXD})}$	delay time from TXD to TRXD	AS_Normal; see <a href="#">Figure 10</a>	<a href="#">[1]</a>			
		DATA_0	-	-	60	ns
		DATA_1	-	-	60	ns
$\Delta t_{d(\text{TXD-TRXD})}$	delay time difference from TXD to TRXD	between DATA_0 and DATA_1; AS_Normal	<a href="#">[1]</a>	-5	+5	ns
$t_{d(\text{TRXD-bus})}$	delay time from TRXD to bus	AS_Normal; see <a href="#">Figure 12</a>				
		DATA_0	-	-	75	ns
		DATA_1	-	-	75	ns
$\Delta t_{d(\text{TRXD-bus})}$	delay time difference from TRXD to bus	between DATA_0 and DATA_1; AS_Normal	<a href="#">[2]</a>	-5	+5	ns
$t_{d(\text{TXEN-busact})}$	delay time from TXEN to bus active	AS_Normal; from idle to active	-	-	150	ns
$t_{d(\text{TXEN-busidle})}$	delay time from TXEN to bus idle	AS_Normal; from active to idle	-	-	150	ns
$t_{d(\text{TXEN-RXD})}$	delay time from TXEN to RXD		-	-	150	ns
$t_{d(\text{TRXD-busact})}$	delay time from TRXD to bus active	$t_{\text{det(act)}(\text{TRXD})} + t_{d(\text{TRXD-bus})}$	-	-	275	ns
$t_{d(\text{TRXD-busidle})}$	delay time from TRXD to bus idle	$t_{\text{det(idle)}(\text{TRXD})} + t_{d(\text{TRXD-bus})}$	-	-	275	ns
$t_{d(\text{busact-TRXD})}$	delay time from bus active to TRXD	$t_{\text{det(act)}(\text{bus})} + t_{d(\text{bus-TRXD})}$	-	-	285	ns
$t_{d(\text{busidle-TRXD})}$	delay time from bus idle to TRXD	$t_{\text{det(idle)}(\text{bus})} + t_{d(\text{bus-TRXD})}$	-	-	275	ns
$t_{d(\text{TRXDact-RXD})}$	delay time from TRXD activity detection to RXD	$t_{\text{det(act)}(\text{TRXD})} + t_{d(\text{TRXD-RXD})}$	-	-	260	ns
$t_{d(\text{busact-bus})}$	delay time from bus active to bus	from one branch to another, including activity detection time; $t_{\text{det(act)}(\text{bus})} + t_{d(\text{bus-bus})}$	-	-	310	ns
$t_{d(\text{busidle-bus})}$	delay time from bus idle to bus	from one branch to another, including idle detection time; $t_{\text{det(idle)}(\text{bus})} + t_{d(\text{bus-bus})}$	-	-	300	ns
<b>Receive path</b>						
$t_{d(\text{bus-TRXD})}$	delay time from bus to TRXD	AS_Normal; see <a href="#">Figure 11</a>				
		DATA_0	-	-	75	ns
		DATA_1	-	-	75	ns
$\Delta t_{d(\text{bus-TRXD})}$	delay time difference from bus to TRXD	between DATA_0 and DATA_1 AS_Normal; $V_{cm} = 2.5\text{ V}$ $R_{pu} = 200\ \Omega$	<a href="#">[2]</a> <a href="#">[3]</a>	-5	+5	ns

**Table 15. Dynamic characteristics ...continued**

All parameters are guaranteed for  $V_{BAT} = 4.45\text{ V to }60\text{ V}$ ;  $V_{CC} = 4.45\text{ V to }5.25\text{ V}$ ;  $V_{BUF} = 4.45\text{ V to }5.25\text{ V}$ ;  $V_{IO} = 2.55\text{ V to }5.25\text{ V}$ ;  $T_{vj} = -40\text{ }^{\circ}\text{C to }+150\text{ }^{\circ}\text{C}$ ;  $R_{bus} = 40\ \Omega$ ,  $C_{bus} = 100\text{ pF}$ ;  $C_{RXD} = 15\text{ pF}$ ;  $C_{TRXD0} = C_{TRXD1} = 50\text{ pF}$  and  $C_{SDO} = 50\text{ pF}$  unless otherwise specified. All voltages are defined with respect to ground; positive currents flow into the IC.

Symbol	Parameter	Conditions	Min	Typ	Max	Unit
$t_{d(\text{bus-RXD})}$	delay time from bus to RXD	AS_Normal; see <a href="#">Figure 11</a>				
		DATA_0	-	-	75	ns
		DATA_1	-	-	75	ns
$\Delta t_{d(\text{bus-RXD})}$	delay time difference from bus to RXD	between DATA_0 and DATA_1 AS_Normal; $V_{cm} = 2.5\text{ V}$	<a href="#">[2]</a> -5	-	+5	ns
$t_{d(\text{TRXD-RXD})}$	delay time from TRXD to RXD	AS_Normal; see <a href="#">Figure 12</a>				
		DATA_0	-	-	60	ns
		DATA_1	-	-	60	ns
$\Delta t_{d(\text{TRXD-RXD})}$	delay time difference from TRXD to RXD	between DATA_0 and DATA_1 AS_Normal	-5	-	+5	ns
$t_{d(\text{TXD-RXD})}$	delay time from TXD to RXD	AS_Normal; see <a href="#">Figure 10</a>	<a href="#">[1]</a>			
		DATA_0	-	30	60	ns
		DATA_1	-	30	60	ns
$t_{d(\text{bus-bus})}$	delay time from bus to bus	from one branch to another AS_Normal; see <a href="#">Figure 11</a>				
		DATA_0	-	-	100	ns
		DATA_1	-	-	100	ns
$\Delta t_{d(\text{bus-bus})}$	delay time difference from bus to bus	between DATA_0 and DATA_1 AS_Normal	-8	-	+8	ns
<b>Bus slope</b>						
$t_{r(\text{dif})(\text{bus})}$	bus differential rise time	DATA_0 to DATA_1; 20 % to 80 %	6	-	18.75	ns
		DATA_0 to idle; -300 mV to -30 mV	-	-	30	ns
$t_{f(\text{dif})(\text{bus})}$	bus differential fall time	DATA_1 to DATA_0; 20 % to 80 %	6	-	18.75	ns
		DATA_1 to idle; 300 mV to 30 mV	-	-	30	ns
		idle to DATA_0; -30 mV to -300 mV	-	-	30	ns
$\Delta t_{(r-f)(\text{dif})}$	difference between differential rise and fall time	between DATA_0 and DATA_1	-3	-	+3	ns
<b>Pin RXD</b>						
$t_r$	rise time	20 % to 80 %	-	-	9	ns
$t_f$	fall time	80 % to 20 %	-	-	9	ns
$t_{(r+f)}$	sum of rise and fall time	20 % to 80 % and 80 % to 20 %	-	-	13	ns
$\Delta t_{(r-f)}$	difference between rise and fall time	20 % to 80 %	-5	-	+5	ns
<b>Pin RSTN</b>						
$t_{\text{def}(\text{rst})}$	reset detection time		5	-	20	$\mu\text{s}$
<b>Pin BGE</b>						
$t_{d(\text{BGE-busact})}$	delay time from BGE to bus active	activity detected on TXEN	-	-	100	ns
$t_{d(\text{BGE-busidle})}$	delay time from BGE to bus idle	activity detected on TXEN	-	-	100	ns

**Table 15. Dynamic characteristics ...continued**

All parameters are guaranteed for  $V_{BAT} = 4.45\text{ V to }60\text{ V}$ ;  $V_{CC} = 4.45\text{ V to }5.25\text{ V}$ ;  $V_{BUF} = 4.45\text{ V to }5.25\text{ V}$ ;  $V_{IO} = 2.55\text{ V to }5.25\text{ V}$ ;  $T_{vj} = -40\text{ }^{\circ}\text{C to }+150\text{ }^{\circ}\text{C}$ ;  $R_{bus} = 40\text{ }\Omega$ ,  $C_{bus} = 100\text{ pF}$ ;  $C_{RXD} = 15\text{ pF}$ ;  $C_{TRXD0} = C_{TRXD1} = 50\text{ pF}$  and  $C_{SDO} = 50\text{ pF}$  unless otherwise specified. All voltages are defined with respect to ground; positive currents flow into the IC.

Symbol	Parameter	Conditions	Min	Typ	Max	Unit
<b>Activity detection</b>						
$t_{det(act)}(TXEN)$	activity detection time on pin TXEN	AS_Normal; from idle to active	20	-	70	ns
$t_{det(idle)}(TXEN)$	idle detection time on pin TXEN	AS_Normal; from active to idle	20	-	70	ns
$\Delta t_{det(act-idle)}$	difference between active and idle detection time					
	on pin TXEN	AS_Normal	-25	-	+25	ns
	on pin TRXD	pins TRXD0 and TRXD1; AS_Normal	-50	-	+50	ns
	on bus	AS_Normal	-50	-	+50	ns
$t_{det(act)}(TRXD)$	activity detection time on pin TRXD	pins TRXD0 and TRXD1; AS_Normal; from idle to active	100	-	200	ns
$t_{det(idle)}(TRXD)$	idle detection time on pin TRXD	pins TRXD0 and TRXD1; AS_Normal; from active to idle	100	-	200	ns
$t_{det(act)}(bus)$	activity detection time on bus pins	AS_Normal; from idle to active	100	-	210	ns
$t_{det(idle)}(bus)$	idle detection time on bus pins	AS_Normal; from active to idle	100	-	200	ns
$t_{det(int)}$	interrupt detection time	from interrupt detection to falling edge on INTN	-	-	100	$\mu\text{s}$
$t_{INTNH(min)}$	minimum INTN HIGH time		10	-	40	$\mu\text{s}$
<b>Wake-up detection</b>						
$t_{det(wake)}DATA\_0$	DATA_0 wake-up detection time	$-10\text{ V} \leq V_{cm} \leq +15\text{ V}$	[3]	1	-	4 $\mu\text{s}$
$t_{det(wake)}idle$	idle wake-up detection time	$-10\text{ V} \leq V_{cm} \leq +15\text{ V}$	[3]	1	-	4 $\mu\text{s}$
$t_{det(wake)}tot$	total wake-up detection time	$-10\text{ V} \leq V_{cm} \leq +15\text{ V}$	[3]	50	-	115 $\mu\text{s}$
$t_{sup(int)}wake$	wake-up interruption suppression time	$-10\text{ V} \leq V_{cm} \leq +15\text{ V}$	[3]	130	-	1000 ns
$t_{d(bus)}(wake-act)$	bus delay time from wake-up to active		-	-	18	$\mu\text{s}$
$t_{det(wake)}(LWU)$	wake-up detection time on pin LWU		2.9	-	175	$\mu\text{s}$
$t_{det(wake)}(TRXD)$	wake-up detection time on pin TRXD	falling edge on TRXD_0 or TRXD_1	100	-	400	ns
$t_{d(LWUwake-INHH)}$	delay time from LWU wake-up to INH HIGH	falling edge on LWU to INH HIGH AS_Sleep; $5.5\text{ V} < V_{BAT} < 27\text{ V}$ $R_{L(INH-GND)} = 100\text{ k}\Omega$	[4]	2.9	-	100 $\mu\text{s}$
		falling edge on LWU to INH HIGH AS_Sleep; $27\text{ V} < V_{BAT} < 60\text{ V}$ $R_{L(INH-GND)} = 100\text{ k}\Omega$	[4]	-	-	175 $\mu\text{s}$
$t_{d(buswake-INHH)}$	delay time from bus wake-up to INH HIGH	AS_Sleep; $V_{BAT} > 5.5\text{ V}$ $R_{L(INH-GND)} = 100\text{ k}\Omega$	[4]	-	-	55 $\mu\text{s}$
$t_{d(buswake-INTNL)}$	delay time from bus wake-up to INTN LOW	AS_Sleep; AS_Standby $V_{BAT} > 5.5\text{ V}$	-	-	10	$\mu\text{s}$
$t_{d(TRXDwake-INHH)}$	delay time from TRXD wake-up to INH HIGH	falling edge on TRXDx to INH HIGH AS_Sleep; $R_{L(INH-GND)} = 100\text{ k}\Omega$	[4]	-	-	55 $\mu\text{s}$

**Table 15. Dynamic characteristics ...continued**

All parameters are guaranteed for  $V_{BAT} = 4.45\text{ V to }60\text{ V}$ ;  $V_{CC} = 4.45\text{ V to }5.25\text{ V}$ ;  $V_{BUF} = 4.45\text{ V to }5.25\text{ V}$ ;  $V_{IO} = 2.55\text{ V to }5.25\text{ V}$ ;  $T_{vj} = -40\text{ }^{\circ}\text{C to }+150\text{ }^{\circ}\text{C}$ ;  $R_{bus} = 40\ \Omega$ ,  $C_{bus} = 100\text{ pF}$ ;  $C_{RXD} = 15\text{ pF}$ ;  $C_{TRXD0} = C_{TRXD1} = 50\text{ pF}$  and  $C_{SDO} = 50\text{ pF}$  unless otherwise specified. All voltages are defined with respect to ground; positive currents flow into the IC.

Symbol	Parameter	Conditions	Min	Typ	Max	Unit
<b>Bus error diagnosis</b>						
$t_{to(BFT)}$	BFT time-out time		80	-	180	ns
<b>Clamp detection</b>						
$t_{detCL(bus)}$	bus clamp detection time		650	-	2600	$\mu\text{s}$
$t_{detCL(TRXD)}$	TRXD clamp detection time		650	-	2600	$\mu\text{s}$
$t_{detCL(TXEN)}$	TXEN clamp detection time		650	-	2600	$\mu\text{s}$
$t_{det(col)(TRXD)}$	TRXD collision detection time		40	-	120	ns
<b>Transition timing</b>						
$t_{to\_stargotosleep}$	dStarGoToSleep time-out time		640	-	6400	ms
$t_{t(bnorm-bdis)}$	branch normal to branch disabled transition time	AS_Normal; after a host 'Branch_Disabled' command; rising edge on SCSN to transmitter deactivated	-	-	1	$\mu\text{s}$
$t_{t(bdis-bnorm)}$	branch disabled to branch normal transition time	AS_Normal; after a host 'Branch_Normal' command; rising edge on SCSN to transmitter activated	-	-	1	$\mu\text{s}$
$t_{t(bnorm-btx2)}$	branch normal to branch TxOnly2 transition time	AS_Normal; after a host 'Branch_TxOnly' command; rising edge on SCSN to deactivating receive function	-	-	1	$\mu\text{s}$
$t_{t(btx2-bnorm)}$	branch TxOnly2 to branch normal transition time	AS_Normal; after a host 'Branch_Normal' command; rising edge on SCSN to activating receive function	-	-	1	$\mu\text{s}$
$t_{t(moch)}$	mode change transition time	after host command AS_Sleep to AS_Standby rising edge on SCSN to rising edge on INH	-	-	25	$\mu\text{s}$

[1] Sum of rise and fall times on TXD (20 % to 80 % on  $V_{IO}$ ) is 9 ns (max).

[2] Guaranteed for  $V_{bus(dif)} = \pm 300\text{ mV}$  and  $V_{bus(dif)} = \pm 150\text{ mV}$ ;  $V_{bus(dif)}$  is the differential bus voltage,  $V_{BP} - V_{BM}$ .

[3]  $V_{cm}$  is the BP/BM common mode voltage ( $V_{cm} = (V_{BP} + V_{BM})/2$ ).

[4] Defined for  $V_{INH} = 2\text{ V}$ .

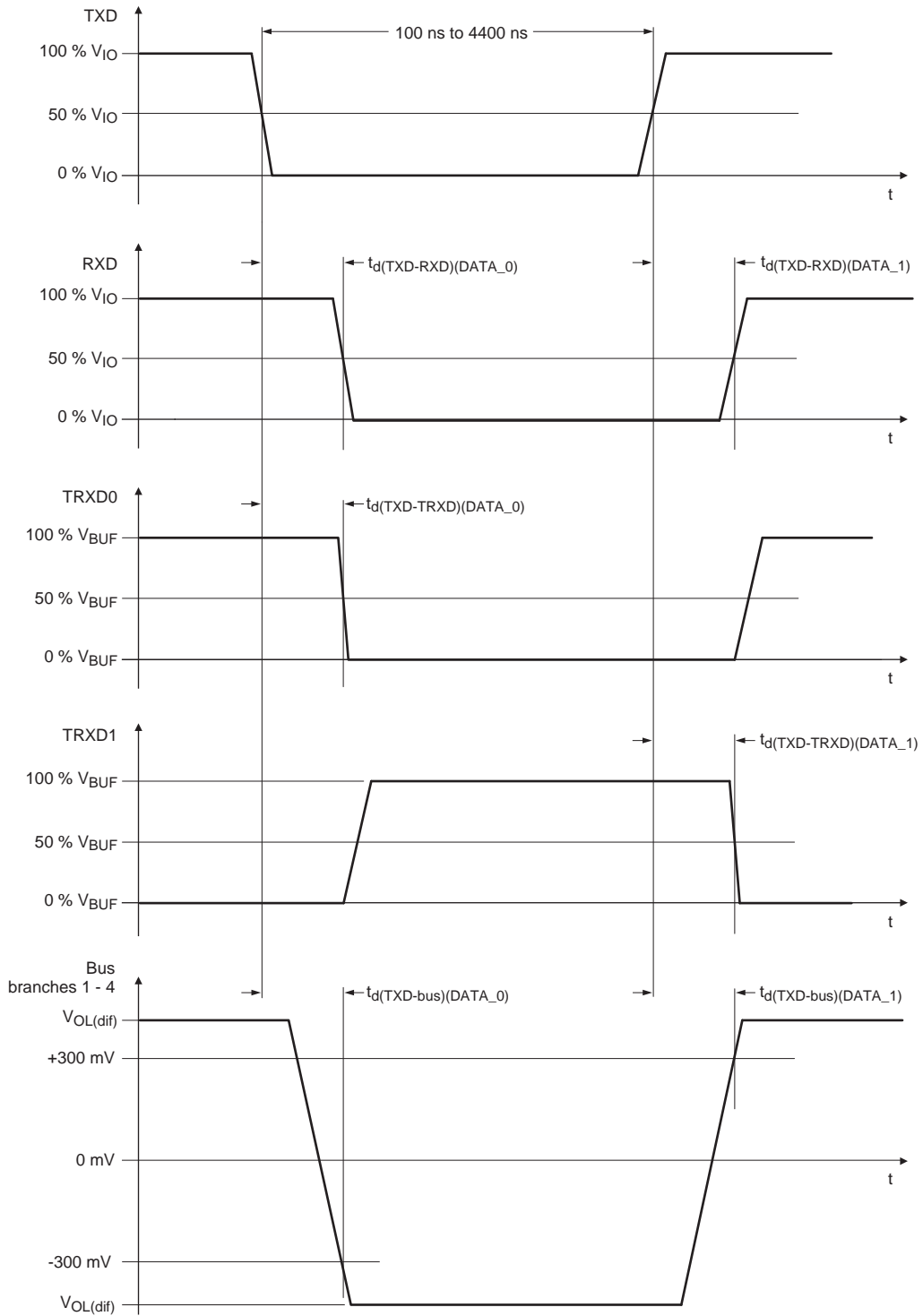

015aaa172

Fig 10. Timing diagram when the CC interface is the input channel

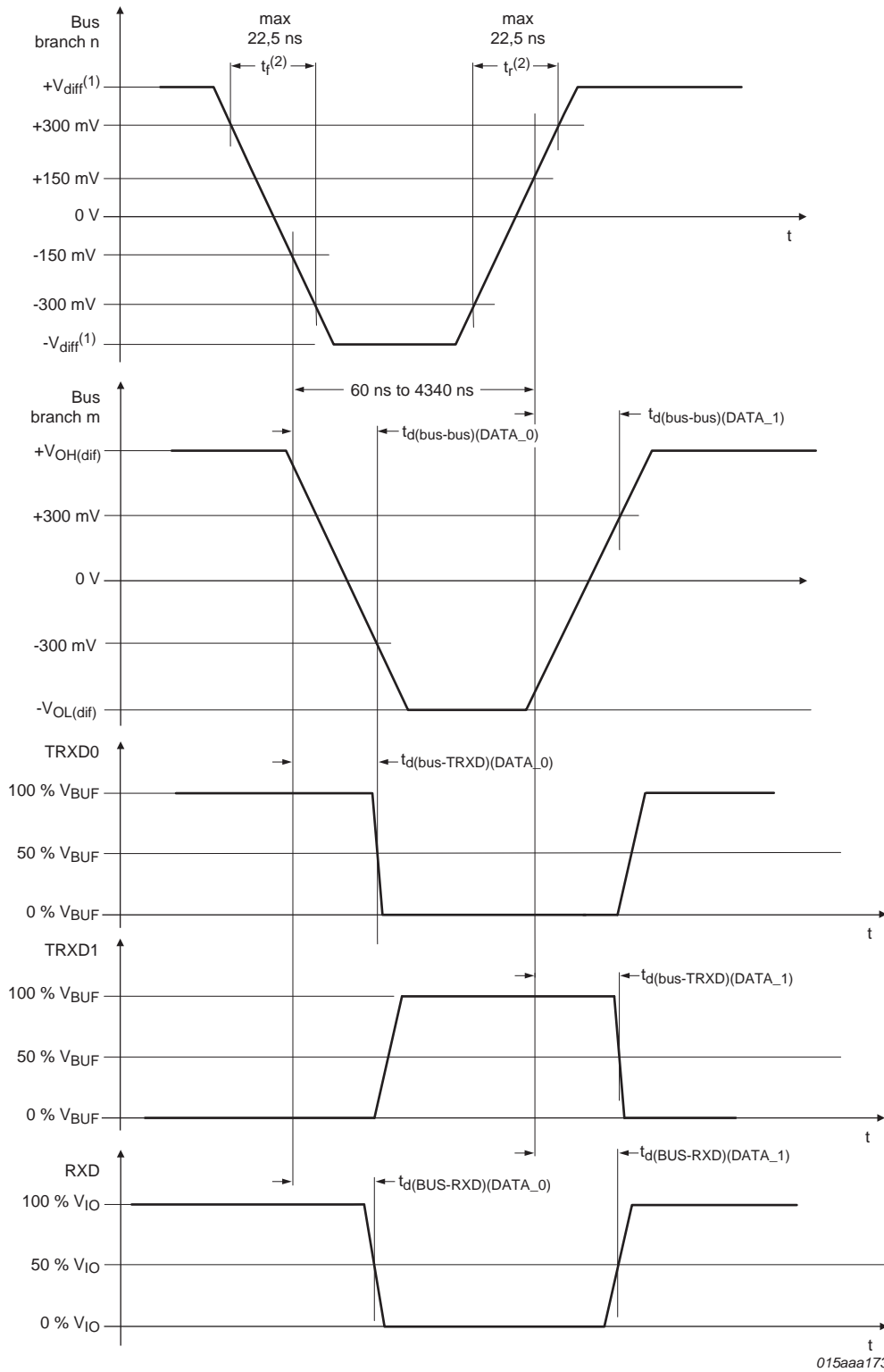

- (1)  $V_{diff} = 400 \text{ mV to } 3000 \text{ mV}$ .
- (2)  $t_r$  and  $t_f$ , defined between  $\pm 300 \text{ mV}$ , are both  $22.5 \text{ ns}$  for bus amplitudes of  $800 \text{ mV}$  (max), and lower for higher bus amplitudes.

**Fig 11. Timing diagram when one of the branches is the input channel**

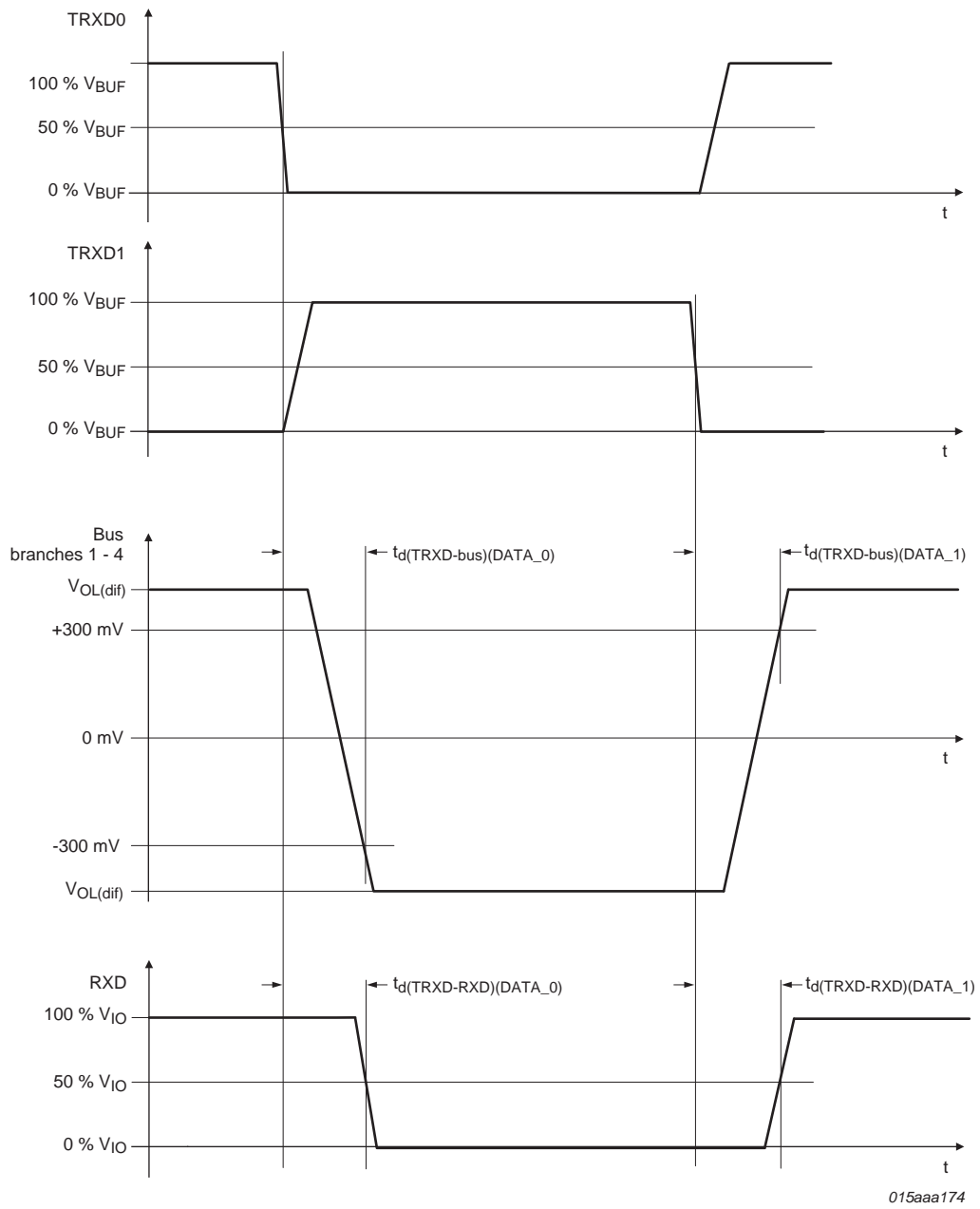

015aaa174

Fig 12. Timing diagram when the internal bus (TRXD0/1) is the input channel



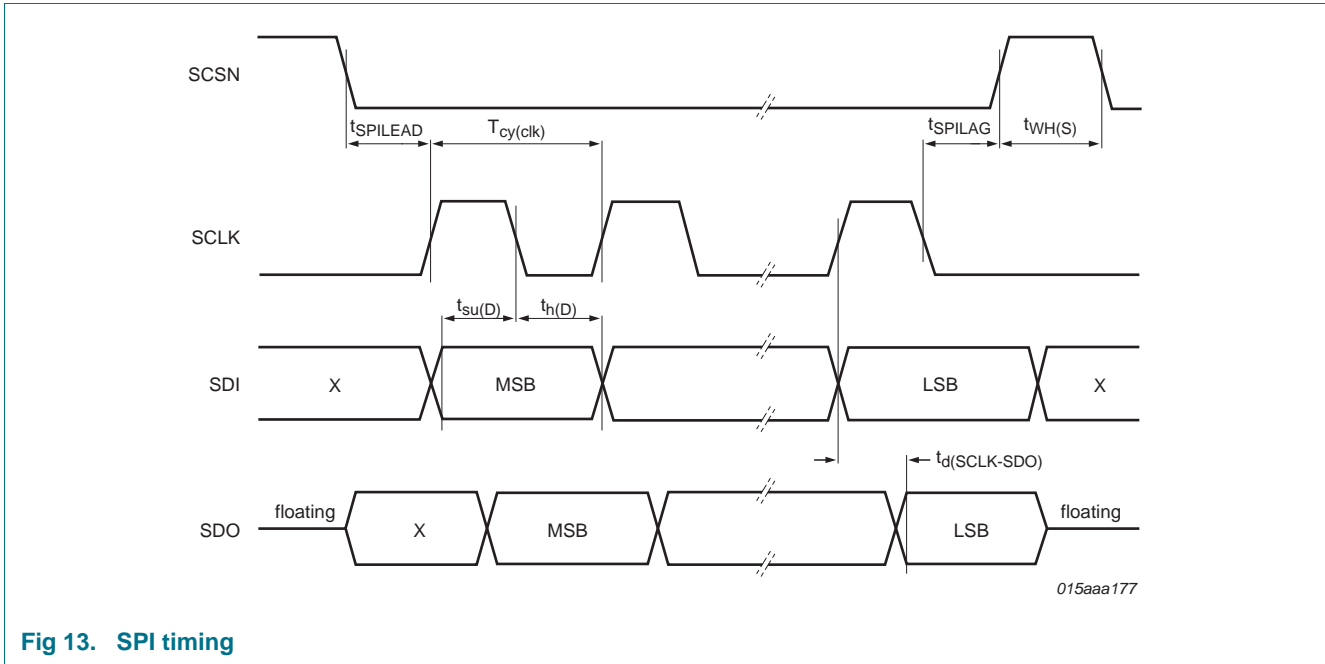

Fig 13. SPI timing

11. Package outline

HVQFN44: plastic thermal enhanced very thin quad flat package; no leads  
44 terminals; body 9 x 9 mm

SOT1113-1

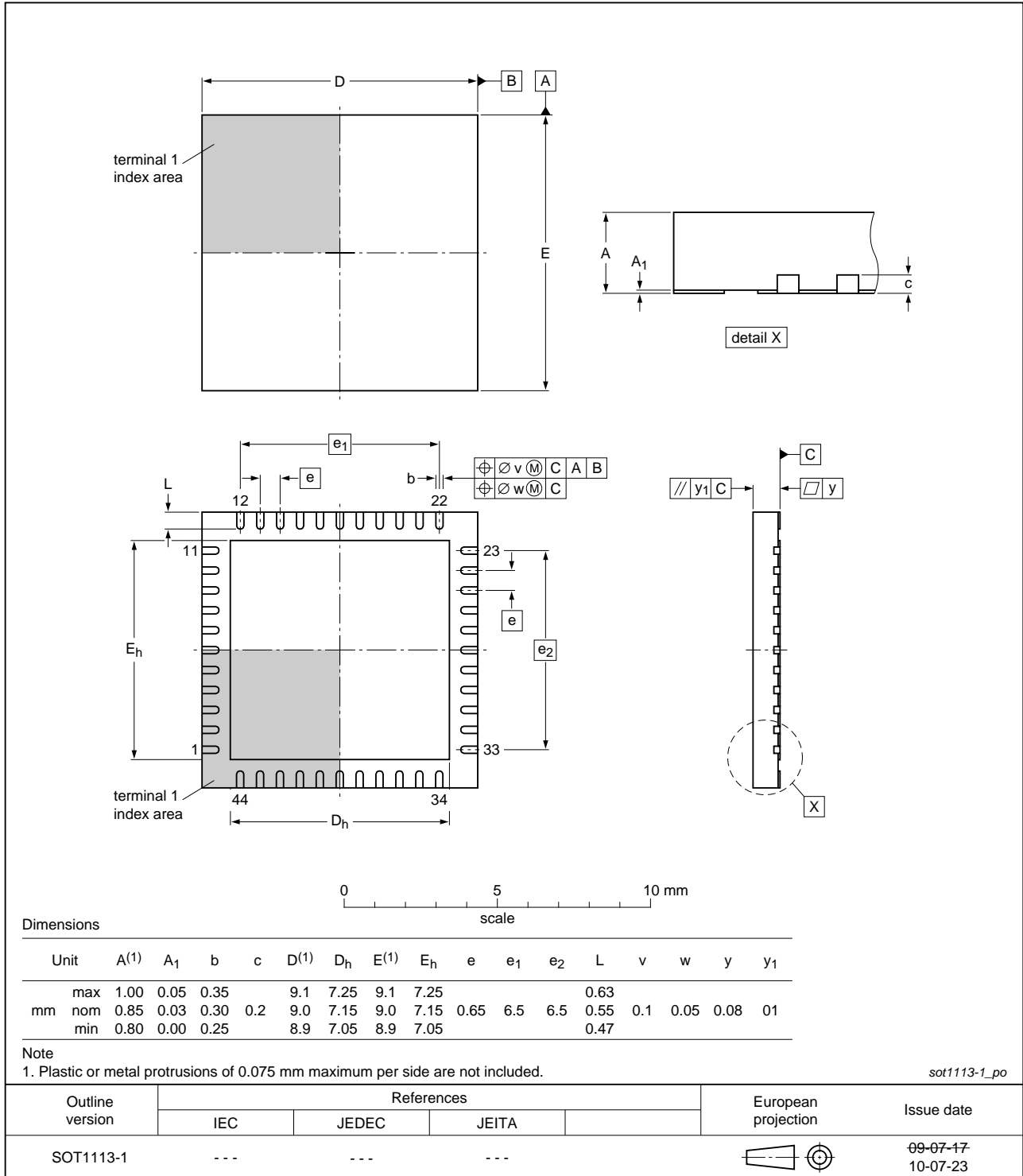

Fig 14. Package outline SOT1113-1 (HVQFN44)

## 12. Soldering of SMD packages

This text provides a very brief insight into a complex technology. A more in-depth account of soldering ICs can be found in Application Note *AN10365 "Surface mount reflow soldering description"*.

### 12.1 Introduction to soldering

Soldering is one of the most common methods through which packages are attached to Printed Circuit Boards (PCBs), to form electrical circuits. The soldered joint provides both the mechanical and the electrical connection. There is no single soldering method that is ideal for all IC packages. Wave soldering is often preferred when through-hole and Surface Mount Devices (SMDs) are mixed on one printed wiring board; however, it is not suitable for fine pitch SMDs. Reflow soldering is ideal for the small pitches and high densities that come with increased miniaturization.

### 12.2 Wave and reflow soldering

Wave soldering is a joining technology in which the joints are made by solder coming from a standing wave of liquid solder. The wave soldering process is suitable for the following:

- Through-hole components
- Leaded or leadless SMDs, which are glued to the surface of the printed circuit board

Not all SMDs can be wave soldered. Packages with solder balls, and some leadless packages which have solder lands underneath the body, cannot be wave soldered. Also, leaded SMDs with leads having a pitch smaller than ~0.6 mm cannot be wave soldered, due to an increased probability of bridging.

The reflow soldering process involves applying solder paste to a board, followed by component placement and exposure to a temperature profile. Leaded packages, packages with solder balls, and leadless packages are all reflow solderable.

Key characteristics in both wave and reflow soldering are:

- Board specifications, including the board finish, solder masks and vias
- Package footprints, including solder thieves and orientation
- The moisture sensitivity level of the packages
- Package placement
- Inspection and repair
- Lead-free soldering versus SnPb soldering

### 12.3 Wave soldering

Key characteristics in wave soldering are:

- Process issues, such as application of adhesive and flux, clinching of leads, board transport, the solder wave parameters, and the time during which components are exposed to the wave
- Solder bath specifications, including temperature and impurities

## 12.4 Reflow soldering

Key characteristics in reflow soldering are:

- Lead-free versus SnPb soldering; note that a lead-free reflow process usually leads to higher minimum peak temperatures (see [Figure 15](#)) than a SnPb process, thus reducing the process window
- Solder paste printing issues including smearing, release, and adjusting the process window for a mix of large and small components on one board
- Reflow temperature profile; this profile includes preheat, reflow (in which the board is heated to the peak temperature) and cooling down. It is imperative that the peak temperature is high enough for the solder to make reliable solder joints (a solder paste characteristic). In addition, the peak temperature must be low enough that the packages and/or boards are not damaged. The peak temperature of the package depends on package thickness and volume and is classified in accordance with [Table 16](#) and [17](#)

**Table 16. SnPb eutectic process (from J-STD-020C)**

Package thickness (mm)	Package reflow temperature (°C)	
	Volume (mm <sup>3</sup> )	
	< 350	≥ 350
< 2.5	235	220
≥ 2.5	220	220

**Table 17. Lead-free process (from J-STD-020C)**

Package thickness (mm)	Package reflow temperature (°C)		
	Volume (mm <sup>3</sup> )		
	< 350	350 to 2000	> 2000
< 1.6	260	260	260
1.6 to 2.5	260	250	245
> 2.5	250	245	245

Moisture sensitivity precautions, as indicated on the packing, must be respected at all times.

Studies have shown that small packages reach higher temperatures during reflow soldering, see [Figure 15](#).

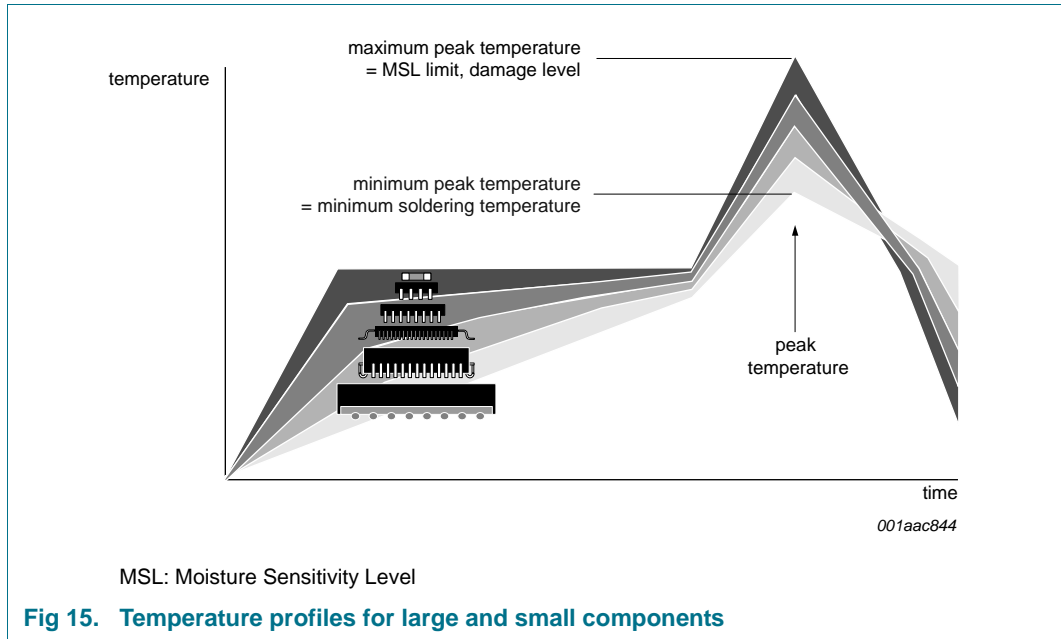

For further information on temperature profiles, refer to Application Note AN10365 “Surface mount reflow soldering description”.

## 13. Appendix: EPL 3.0.1 to TJA1085 parameter conversion

Table 18. EPL 3.0.1 to TJA1085 conversion

EPL 3.0.1				TJA1085			
Symbol	Min	Max	Unit	Symbol	Min	Max	Unit
dBusTx01	6	18.75	ns	$t_{r(dif)(bus)}$	6	18.75	ns
dBusTx10	6	18.75	ns	$t_{f(dif)(bus)}$	6	18.75	ns
uStarTxactive	600	2000	mV	$ V_{OH(dif)} ,  V_{OL(dif)} $	900	2000	mV
uStarTxidle	0	30	mV	$ V_{o(idle)(dif)} $	0	25	mV
dBranchRxActiveMax	650	2600	$\mu$ s	$t_{detCL(bus)}$	650	2600	$\mu$ s
$R_{CM1}, R_{CM2}$	10	40	k $\Omega$	$R_i$ (pins BP and BM)	10	40	k $\Omega$
uCM	-10	+15	V	$V_{cm}$ <sup>[1]</sup>	-10	+15	V
uStarUVV <sub>BAT</sub>	4	5.5	V	$V_{uvd}(VBAT)$	4.45	4.715	V
uStarUVV <sub>CC</sub>	4	-	V	$V_{uvd}(VCC)$	4.45	4.715	V
dStarUVV <sub>CC</sub>	-	1000	ms	$t_{det(uv)(VCC)}$	5	100	$\mu$ s
iBP <sub>Leak</sub>	-	25	$\mu$ A	$ I_{LI}(BP) $	-	5	$\mu$ A
iBM <sub>Leak</sub>	-	25	$\mu$ A	$ I_{LI}(BM) $	-	5	$\mu$ A
iBM <sub>GNDShortMax</sub>	-	60	mA	$ I_{O(sc)} $ (pin BM)	-	60	mA
iBP <sub>GNDShortMax</sub>	-	60	mA	$ I_{O(sc)} $ (pin BP)	-	60	mA
iBM <sub>BAT48ShortMax</sub>	-	72	mA	$ I_{O(sc)} $ (pin BM)	-	72	mA
iBP <sub>BAT48ShortMax</sub>	-	72	mA	$ I_{O(sc)} $ (pin BP)	-	72	mA
iBM <sub>BAT27ShortMax</sub>	-	60	mA	$ I_{O(sc)} $ (pin BM)	-	60	mA
iBP <sub>BAT27ShortMax</sub>	-	60	mA	$ I_{O(sc)} $ (pin BP)	-	60	mA
functional class: Active Star - bus guardian interface	implemented (see <a href="#">Section 2.4</a> )						
dStarDelay10	-	150	ns	$t_{d(bus-TRXD)} + t_{d(TRXD-bus)}$	-	150	ns
dStarDelay01	-	150	ns	$t_{d(bus-TRXD)} + t_{d(TRXD-bus)}$	-	150	ns
dStarAsym	0	8	ns	$ \Delta t_{d(bus-bus)} $	-	8	ns
dStarAsym2	0	10	ns	$ \Delta t_{d(bus-TRXD)}  +  \Delta t_{d(TRXD-bus)} $	-	10	ns
dStarSetUpDelay	-	500	ns	$t_{det(act)(TXEN)} + t_{d(TXD-TRXD)}$	20	110	ns
				$t_{det(act)(bus)} + t_{d(bus-TRXD)}$	100	285	ns
dStarGoToSleep	640	6400	ms	$t_{to\_stargotosleep}$	640	6400	ms
dStarWakeupReactionTime	-	70	$\mu$ s	$t_{d(bus)(wake-act)}$	-	18	$\mu$ s
device qualification according to AEC-Q100 (Rev. F)	see <a href="#">Section 2.1</a>						
$T_{AMB\_Class1}$	-40	+125	$^{\circ}$ C	$T_{amb}$	-40	+125	$^{\circ}$ C
iBM <sub>-5VshortMax</sub>	-	60	mA	$ I_{O(sc)} $ (pin BM)	-	60	mA
iBP <sub>-5VshortMax</sub>	-	60	mA	$ I_{O(sc)} $ (pin BP)	-	60	mA
functional class: Active Star - voltage regulator control	implemented (see <a href="#">Section 2.4</a> )						
iBM <sub>BPSshortMax</sub>	-	60	mA	$ I_{O(sc)} $ (BP to BM)	-	60	mA
iBP <sub>BMSshortMax</sub>	-	60	mA	$ I_{O(sc)} $ (BM to BP)	-	60	mA
iBM <sub>BAT60ShortMax</sub>	-	90	mA	$ I_{O(sc)} $ (pin BP)	-	72	mA
iBP <sub>BAT60ShortMax</sub>	-	90	mA	$ I_{O(sc)} $ (pin BM)	-	72	mA
uBias - Non-Low Power	1800	3200	mV	$V_{o(idle)(BP)}, V_{o(idle)(BM)}$ <sup>[2]</sup>	1800	3150	mV
uBias - Low Power	-200	+200	mV	$V_{o(idle)(BP)}, V_{o(idle)(BM)}$ <sup>[3]</sup>	-100	+100	mV

Table 18. EPL 3.0.1 to TJA1085 conversion ...continued

EPL 3.0.1				TJA1085			
Symbol	Min	Max	Unit	Symbol	Min	Max	Unit
dStarUVV <sub>BAT</sub>	-	1000	ms	t <sub>det(uv)</sub> (VBAT)	5	150	μs
uStarUVV <sub>IO</sub>	2	-	V	V <sub>uvd</sub> (VIO)	2.55	2.765	V
dStarUVV <sub>IO</sub>	-	1000	ms	t <sub>det(uv)</sub> (VIO)	5	100	μs
uINH1 <sub>Not_Sleep</sub>	uVBAT - 1 V	-	V	V <sub>OH</sub> (pin INH)	V <sub>BAT</sub> - 0.8 V	V <sub>BAT</sub>	V
iINH1 <sub>Leak</sub>	-	10	μA	I <sub>L</sub> (pin INH)	-3	+3	μA
dStarTSSLengthChange	-450	0	ns	-(t <sub>det(act)</sub> (bus) + t <sub>det(act)</sub> (TRXD))	-410	-	ns
				-t <sub>det(act)</sub> (bus)	-	-100	ns
dStarFES1LengthChange	0	450	ns	t <sub>det(idle)</sub> (bus)	100	-	ns
				t <sub>det(idle)</sub> (bus) + t <sub>det(idle)</sub> (TRXD)	-	400	ns
dStarUVV <sub>Supply</sub>	-	1	ms	t <sub>det(uv)</sub> (VBUF)	5	100	μs
dStarRV <sub>Supply</sub>	-	10	ms	t <sub>rec(uv)</sub> (VBUF)	5	100	μs
uStarUVV <sub>Supply</sub>	4	-	V	V <sub>uvd</sub> (VBUF)	4.2	4.474	V
dStarRV <sub>BAT</sub>	-	10	ms	t <sub>rec(uv)</sub> (VBAT)	5	150	μs
dStarRV <sub>CC</sub>	-	10	ms	t <sub>rec(uv)</sub> (VCC)	5	100	μs
dStarRV <sub>IO</sub>	-	10	ms	t <sub>rec(uv)</sub> (VIO)	5	100	μs
dWU <sub>Interrupt</sub>	0.13	1	μs	t <sub>sup(int)</sub> wake	130	1000	ns
dWU <sub>0Detect</sub>	1	4	μs	t <sub>det(wake)</sub> DATA_0	1	4	μs
dWU <sub>IdleDetect</sub>	1	4	μs	t <sub>det(wake)</sub> idle	1	4	μs
dWU <sub>Timeout</sub>	48	140	μs	t <sub>det(wake)</sub> tot	50	115	μs
dStarWakePulseFilter	1	500	μs	t <sub>det(wake)</sub> (LWU)	2.9	175	μs
iBP <sub>LeakGND</sub>	-	1600	μA	I <sub>L</sub> (BP)	-	1600	μA
iBM <sub>LeakGND</sub>	-	1600	μA	I <sub>L</sub> (BM)	-	1600	μA
dStarWakeUpReaction <sub>local</sub>	-	100	μs	t <sub>d</sub> (LWUwake-INHH)	0	100	μs
dStarSymbolLengthChange	-300	+450	ns	Δt <sub>det(act-idle)</sub> (bus) + Δt <sub>det(act-idle)</sub> (TRXD)	-100	+100	ns
functional class: Active Star - logic level adaptation				implemented (see <a href="#">Section 2.4</a> )			
functional class: Active Star - increased voltage amplitude transmitter				implemented (see <a href="#">Section 2.4</a> )			
uESD <sub>EXT</sub>	6	-	kV	V <sub>ESD</sub>  : HBM on pins BP and BM to GND	8	-	kV
				V <sub>ESD</sub>  : HBM on pins LWU and V <sub>BAT</sub> to GND	6	-	kV
uESD <sub>INT</sub>	2	-	kV	V <sub>ESD</sub>   (HBM on any other pin)	4	-	kV
uESD <sub>IEC</sub>	6	-	kV	IEC61000-4-2 on pins BP and BM to GND	6	-	kV
uV <sub>BAT-WAKE</sub>	-	7	V	V <sub>BAT</sub>	4.75	60	V
dBusTxai	-	30	ns	t <sub>r(dif)</sub> (bus) (DATA_0 to idle)	-	30	ns
dBusTxia	-	30	ns	t <sub>r(dif)</sub> (bus) (idle to DATA_0)	-	30	ns
valid operating modes when V <sub>StarSupply</sub> = nominal; V <sub>BAT</sub> ≥ 7 V; V <sub>CC</sub> = nominal				AS_Sleep, AS_Standby, AS_Normal			

Table 18. EPL 3.0.1 to TJA1085 conversion ...continued

EPL 3.0.1				TJA1085			
Symbol	Min	Max	Unit	Symbol	Min	Max	Unit
valid operating modes when $V_{StarSupply} = \text{nominal}$ ; $V_{BAT} \geq 5.5 \text{ V}$ ; $V_{CC} = \text{nominal}$				AS_Sleep, AS_Standby, AS_Normal			
dBusTxDif	-	3	ns	$ \Delta t_{(r-f)(dif)} $	-	3	ns
RStarTransmitter	product-specific			$Z_{o(eq)}(TX)$	10	600	$\Omega$
dStarSymbolEndLengthChange	0	450	ns	$t_{det(idle)(bus)}$	100	-	ns
				$t_{det(idle)(bus)} + t_{det(idle)(TRXD)}$	-	400	ns
<b>Active star with communication controller interface</b>							
dStarRxAsym	-	10	ns	$ \Delta t_{d(bus-TRXD)}  +  \Delta t_{d(TRXD-RXD)} $	-	10	ns
dStarRx10	-	225	ns	$t_{d(bus-TRXD)} + t_{d(TRXD-RXD)}$	-	135	ns
dStarRx01	-	225	ns	$t_{d(bus-TRXD)} + t_{d(TRXD-RXD)}$	-	135	ns
dStarRxai	50	550	ns	$t_{det(idle)(bus)} + t_{d(bus-RXD)}$	100	-	ns
				$t_{det(idle)(bus)} + t_{d(bus-TRXD)} + t_{det(idle)(TRXD)} + t_{d(TRXD-RXD)}$	-	535	ns
dStarRxia	100	550	ns	$t_{det(act)(bus)} + t_{d(bus-RXD)}$	100	-	ns
				$t_{det(act)(bus)} + t_{d(bus-TRXD)} + t_{det(act)(TRXD)} + t_{d(TRXD-RXD)}$	-	545	ns
dStarTxAsym	-	10	ns	$ \Delta t_{d(TXD-TRXD)}  + \Delta t_{d(TRXD-bus)}$	-	10	ns
dStarTx10	-	225	ns	$t_{d(TXD-TRXD)} + t_{d(TRXD-bus)}$	-	135	ns
dStarTx01	-	225	ns	$t_{d(TXD-TRXD)} + t_{d(TRXD-bus)}$	-	135	ns
dStarTxai	-	550	ns	$t_{det(idle)(TXEN)} + t_{d(TXD-TRXD)} + t_{det(idle)(TRXD)} + t_{d(TRXD-bus)}$	-	385	ns
dStarTxia	-	550	ns	$t_{det(act)(TXEN)} + t_{d(TXD-TRXD)} + t_{det(act)(TRXD)} + t_{d(TRXD-bus)}$	-	385	ns
uVDIG-OUT-HIGH	80	100	%	$V_{OH}$ (pin RXD)	$V_{IO} - 0.4$	$V_{IO}$	V
uVDIG-OUT-LOW	-	20	%	$V_{OL}$ (pin RXD)	-	0.4	V
uVDIG-IN-HIGH	-	70	%	$V_{IH}$ (pins TXEN and BGE)	$0.7V_{IO}$	5.5	V
uVDIG-IN-LOW	30	-	%	$V_{IL}$ (pins TXEN and BGE)	-0.3	$0.3V_{IO}$	V
uData0	-300	-150	mV	$V_{IL(dif)}$ (pins BP and BM)	-300	-150	mV
uData1	150	300	mV	$V_{IH(dif)}$ (pins BP and BM)	150	300	mV
uData1 -  uData0	-30	+30	mV	$\Delta V_{i(dif)(H-L)}$	-30	+30	mV
uStarLogic_1	-	60	%	$V_{IH}$ (pin TXD)	$0.6V_{IO}$	5.5	V
uStarLogic_0	40	-	%	$V_{IL}$ (pin TXD)	-0.3	$0.4V_{IO}$	V
dStarRxD <sub>R15</sub> + dStarRxD <sub>F15</sub>	-	13	ns	$t_{(r+f)}$ (pin RXD)	-	13	ns
functional class: Active Star - communication controller interface				implemented			
dStarTxRxai	-	325	ns	$t_{d(TXEN-RXD)}$	-	150	ns
C_StarTxD	-	10	pF	$C_i$ (pin TXD)	-	10	pF
uVDIG-OUT-UV	-	500	mV	$V_O$ (pin RXD) <sup>[4]</sup>	-	500	mV
uData0_LP	-400	-100	mV	$V_{IL(dif)}$ (pins BP and BM)	-400	-125	mV
uVDIG-OUT-OFF	product specific			$V_O$ (pin RXD) <sup>[5]</sup>	$V_{IO} - 500$	$V_{IO}$	mV



Table 18. EPL 3.0.1 to TJA1085 conversion ...continued

EPL 3.0.1				TJA1085			
Symbol	Min	Max	Unit	Symbol	Min	Max	Unit
dStarTSSLengthChange_TxD_Bus	-450	0	ns	$-(t_{det(act)}(TXEN) + t_{det(act)}(TRXD))$	-250	-	ns
				$-t_{det(act)}(TXEN)$	-	-20	ns
dStarFES1LengthChange_TxD_Bus	0	450	ns	$t_{det(idle)}(TXEN)$	20	-	ns
				$t_{det(idle)}(TXEN) + t_{det(idle)}(TRXD)$	-	250	ns
dStarSymbolLengthChange_TxD_Bus	-300	+400	ns	$\Delta t_{det(act-idle)}(TXEN) + \Delta t_{det(act-idle)}(TRXD)$	-75	+75	ns
dStarTSSLengthChange_Bus_RxD	-450	0	ns	$-(t_{det(act)}(bus) + t_{det(act)}(TRXD))$	-410	-	ns
				$-t_{det(act)}(bus)$	-	-100	ns
dStarFES1LengthChange_Bus_RxD	0	450	ns	$t_{det(idle)}(bus)$	100	-	ns
				$t_{det(idle)}(bus) + t_{det(idle)}(TRXD)$	-	400	ns
dStarSymbolLengthChange_Bus_RxD	-300	+400	ns	$\Delta t_{det(act-idle)}(bus) + \Delta t_{det(act-idle)}(TRXD)$	-100	+100	ns
dStarActivityDetection	100	250	ns	$t_{det(act)}(bus)$	100	210	ns
dStarIdleDetection	50	200	ns	$t_{det(idle)}(bus)$	100	200	ns
$ dStarRxD_{R15} - dStarRxD_{F15} $	-	5	ns	$ \Delta t_{(r-f)} $ (pin RXD)	-	5	ns
dStarTxActiveMax	650	2600	$\mu$ s	$t_{detCL}(TXEN)$	650	2600	$\mu$ s
dStarTx <sub>reaction</sub>	-	75	ns	$t_{det(idle)}(TXEN)$	20	50	ns
<b>Active Star with host interface</b>							
dStarModeChange <sub>SPI</sub>	-	100	$\mu$ s	$t_t(moch)$	-	25	$\mu$ s
dStarReactionTime <sub>SPI</sub>	-	200	$\mu$ s	$t_{det(int)}$	-	100	$\mu$ s
$uV_{DIG-OUT-HIGH}$	80	100	%	$V_{OH}$ (pin SDO)	$V_{IO} - 0.4$	$V_{IO}$	V
$uV_{DIG-OUT-LOW}$	-	20	%	$V_{OL}$ (pins SDO, INTN)	-	0.4	V
$uV_{DIG-IN-HIGH}$	-	70	%	$V_{IH}$ (pins SDI, SCSN, SCLK)	$0.7V_{IO}$	5.5	V
$uV_{DIG-IN-LOW}$	30	-	%	$V_{IL}$ (pins SDI, SCSN, SCLK)	-0.3	$0.3V_{IO}$	V
Functional class: Active Star - host interface				implemented			
SPI	0.01	1	Mbit/s	$t_{cl}(clk)$	0.5	100	$\mu$ s
$uV_{DIG-OUT-UV}$	-	500	mV	$V_O$ (pins SDO, INTN) <sup>[4]</sup>	-	500	mV
$uV_{DIG-OUT-OFF}$	product specific			$V_O$ (pins SDO, INTN) <sup>[5]</sup>	-	500	mV
behavior when SCK not connected				pull-down behavior on SCLK			
behavior when SDI not connected				pull-down behavior on SDI			
behavior when SCSN not connected				pull-up behavior on SCSN			

[1]  $V_{cm}$  is the BP/BM common mode voltage,  $(V_{BP} + V_{BM})/2$ , and is specified in conditions column for parameters  $V_{IH(dif)}$  and  $V_{IL(dif)}$  for pins BP and BM; see Table 14.  $V_{cm}$  is tested on a receiving bus driver with a transmitting bus driver that has a ground offset voltage in the range -12.5 V to +12.5 V and transmits a 50/50 pattern.

[2] Min:  $V_{o(idle)}(BP) = V_{o(idle)}(BM) = 0.4V_{BUF} = 0.4 \times 4.5 V = 1800 mV$ ; max value:  $V_{o(idle)}(BP) = V_{o(idle)}(BM) = 0.6V_{BUF} = 0.6 \times 5.25 V = 3150 mV$ ; the nominal voltage is 2500 mV.

[3] The nominal voltage is 0 mV.

[4] When undervoltage on  $V_{IO}$

[5] When  $V_{CC} = V_{BAT} = V_{BUF} = 0 V$ .

## 14. Abbreviations

Table 19. Abbreviations

Abbreviation	Description
CC	Communication Controller
ECU	Engine Control Unit
EMC	Electro Magnetic Compatibility
ESD	ElectroStatic Discharge

## 15. References

- [1] **EPL** — FlexRay Communications System Electrical Physical Layer Specification Version 3.0.1, FlexRay Consortium

## 16. Revision history

Table 20. Revision history

Document ID	Release date	Data sheet status	Change notice	Supersedes
TJA1085 v.1	20121023	Product data sheet	-	-

## 17. Legal information

### 17.1 Data sheet status

Document status <sup>[1][2]</sup>	Product status <sup>[3]</sup>	Definition
Objective [short] data sheet	Development	This document contains data from the objective specification for product development.
Preliminary [short] data sheet	Qualification	This document contains data from the preliminary specification.
Product [short] data sheet	Production	This document contains the product specification.

[1] Please consult the most recently issued document before initiating or completing a design.

[2] The term 'short data sheet' is explained in section "Definitions".

[3] The product status of device(s) described in this document may have changed since this document was published and may differ in case of multiple devices. The latest product status information is available on the Internet at URL <http://www.nxp.com>.

### 17.2 Definitions

**Draft** — The document is a draft version only. The content is still under internal review and subject to formal approval, which may result in modifications or additions. NXP Semiconductors does not give any representations or warranties as to the accuracy or completeness of information included herein and shall have no liability for the consequences of use of such information.

**Short data sheet** — A short data sheet is an extract from a full data sheet with the same product type number(s) and title. A short data sheet is intended for quick reference only and should not be relied upon to contain detailed and full information. For detailed and full information see the relevant full data sheet, which is available on request via the local NXP Semiconductors sales office. In case of any inconsistency or conflict with the short data sheet, the full data sheet shall prevail.

**Product specification** — The information and data provided in a Product data sheet shall define the specification of the product as agreed between NXP Semiconductors and its customer, unless NXP Semiconductors and customer have explicitly agreed otherwise in writing. In no event however, shall an agreement be valid in which the NXP Semiconductors product is deemed to offer functions and qualities beyond those described in the Product data sheet.

### 17.3 Disclaimers

**Limited warranty and liability** — Information in this document is believed to be accurate and reliable. However, NXP Semiconductors does not give any representations or warranties, expressed or implied, as to the accuracy or completeness of such information and shall have no liability for the consequences of use of such information. NXP Semiconductors takes no responsibility for the content in this document if provided by an information source outside of NXP Semiconductors.

In no event shall NXP Semiconductors be liable for any indirect, incidental, punitive, special or consequential damages (including - without limitation - lost profits, lost savings, business interruption, costs related to the removal or replacement of any products or rework charges) whether or not such damages are based on tort (including negligence), warranty, breach of contract or any other legal theory.

Notwithstanding any damages that customer might incur for any reason whatsoever, NXP Semiconductors' aggregate and cumulative liability towards customer for the products described herein shall be limited in accordance with the *Terms and conditions of commercial sale* of NXP Semiconductors.

**Right to make changes** — NXP Semiconductors reserves the right to make changes to information published in this document, including without limitation specifications and product descriptions, at any time and without notice. This document supersedes and replaces all information supplied prior to the publication hereof.

**Suitability for use in automotive applications** — This NXP Semiconductors product has been qualified for use in automotive applications. Unless otherwise agreed in writing, the product is not designed, authorized or warranted to be suitable for use in life support, life-critical or safety-critical systems or equipment, nor in applications where failure or malfunction of an NXP Semiconductors product can reasonably be expected to result in personal injury, death or severe property or environmental damage. NXP Semiconductors and its suppliers accept no liability for inclusion and/or use of NXP Semiconductors products in such equipment or applications and therefore such inclusion and/or use is at the customer's own risk.

**Applications** — Applications that are described herein for any of these products are for illustrative purposes only. NXP Semiconductors makes no representation or warranty that such applications will be suitable for the specified use without further testing or modification.

Customers are responsible for the design and operation of their applications and products using NXP Semiconductors products, and NXP Semiconductors accepts no liability for any assistance with applications or customer product design. It is customer's sole responsibility to determine whether the NXP Semiconductors product is suitable and fit for the customer's applications and products planned, as well as for the planned application and use of customer's third party customer(s). Customers should provide appropriate design and operating safeguards to minimize the risks associated with their applications and products.

NXP Semiconductors does not accept any liability related to any default, damage, costs or problem which is based on any weakness or default in the customer's applications or products, or the application or use by customer's third party customer(s). Customer is responsible for doing all necessary testing for the customer's applications and products using NXP Semiconductors products in order to avoid a default of the applications and the products or of the application or use by customer's third party customer(s). NXP does not accept any liability in this respect.

**Limiting values** — Stress above one or more limiting values (as defined in the Absolute Maximum Ratings System of IEC 60134) will cause permanent damage to the device. Limiting values are stress ratings only and (proper) operation of the device at these or any other conditions above those given in the Recommended operating conditions section (if present) or the Characteristics sections of this document is not warranted. Constant or repeated exposure to limiting values will permanently and irreversibly affect the quality and reliability of the device.

**Terms and conditions of commercial sale** — NXP Semiconductors products are sold subject to the general terms and conditions of commercial sale, as published at <http://www.nxp.com/profile/terms>, unless otherwise agreed in a valid written individual agreement. In case an individual agreement is concluded only the terms and conditions of the respective agreement shall apply. NXP Semiconductors hereby expressly objects to applying the customer's general terms and conditions with regard to the purchase of NXP Semiconductors products by customer.

**No offer to sell or license** — Nothing in this document may be interpreted or construed as an offer to sell products that is open for acceptance or the grant, conveyance or implication of any license under any copyrights, patents or other industrial or intellectual property rights.

**Export control** — This document as well as the item(s) described herein may be subject to export control regulations. Export might require a prior authorization from competent authorities.

**Translations** — A non-English (translated) version of a document is for reference only. The English version shall prevail in case of any discrepancy between the translated and English versions.

## 17.4 Licenses

### NXP ICs with FlexRay functionality

This NXP product contains functionality that is compliant with the FlexRay specifications.

These specifications and the material contained in them, as released by the FlexRay Consortium, are for the purpose of information only. The FlexRay Consortium and the companies that have contributed to the specifications shall not be liable for any use of the specifications.

The material contained in these specifications is protected by copyright and other types of Intellectual Property Rights. The commercial exploitation of the material contained in the specifications requires a license to such Intellectual Property Rights.

These specifications may be utilized or reproduced without any modification, in any form or by any means, for informational purposes only. For any other purpose, no part of the specifications may be utilized or reproduced, in any form or by any means, without permission in writing from the publisher.

The FlexRay specifications have been developed for automotive applications only. They have neither been developed nor tested for non-automotive applications.

The word FlexRay and the FlexRay logo are registered trademarks.

## 17.5 Trademarks

Notice: All referenced brands, product names, service names and trademarks are the property of their respective owners.

## 18. Contact information

For more information, please visit: <http://www.nxp.com>

For sales office addresses, please send an email to: [salesaddresses@nxp.com](mailto:salesaddresses@nxp.com)

## 19. Contents

<b>1</b>	<b>General description</b> . . . . .	<b>1</b>	6.10.2	SPI registers . . . . .	20
<b>2</b>	<b>Features and benefits</b> . . . . .	<b>1</b>	6.10.2.1	Control register . . . . .	22
2.1	General . . . . .	1	6.10.2.2	Configuration register . . . . .	23
2.2	Functional . . . . .	1	6.10.2.3	Interrupt Status register . . . . .	25
2.3	Robustness . . . . .	2	6.10.2.4	General Status register . . . . .	28
2.4	Active star functional classes . . . . .	2	6.10.2.5	Branch X status registers . . . . .	31
<b>3</b>	<b>Ordering information</b> . . . . .	<b>2</b>	<b>7</b>	<b>Limiting values</b> . . . . .	<b>33</b>
<b>4</b>	<b>Block diagram</b> . . . . .	<b>3</b>	<b>8</b>	<b>Thermal characteristics</b> . . . . .	<b>34</b>
<b>5</b>	<b>Pinning information</b> . . . . .	<b>4</b>	<b>9</b>	<b>Static characteristics</b> . . . . .	<b>35</b>
5.1	Pinning . . . . .	4	<b>10</b>	<b>Dynamic characteristics</b> . . . . .	<b>41</b>
5.2	Pin description . . . . .	4	<b>11</b>	<b>Package outline</b> . . . . .	<b>50</b>
<b>6</b>	<b>Functional description</b> . . . . .	<b>6</b>	<b>12</b>	<b>Soldering of SMD packages</b> . . . . .	<b>51</b>
6.1	Supply voltage . . . . .	6	12.1	Introduction to soldering . . . . .	51
6.2	Host Control (HC) and Autonomous Power (AP) modes - APM flag . . . . .	6	12.2	Wave and reflow soldering . . . . .	51
6.3	Signal router . . . . .	6	12.3	Wave soldering . . . . .	51
6.3.1	TRXD collision . . . . .	6	12.4	Reflow soldering . . . . .	52
6.4	Wake-up . . . . .	7	<b>13</b>	<b>Appendix: EPL 3.0.1 to TJA1085 parameter conversion</b> . . . . .	<b>54</b>
6.4.1	Remote wake-up . . . . .	7	<b>14</b>	<b>Abbreviations</b> . . . . .	<b>58</b>
6.4.1.1	Bus wake-up via wake-up pattern . . . . .	7	<b>15</b>	<b>References</b> . . . . .	<b>58</b>
6.4.1.2	Bus wake-up via dedicated FlexRay data frame . . . . .	8	<b>16</b>	<b>Revision history</b> . . . . .	<b>58</b>
6.4.2	Local wake-up via pin LWU . . . . .	9	<b>17</b>	<b>Legal information</b> . . . . .	<b>59</b>
6.4.3	Wake-up via the TRXD0/1 interface . . . . .	9	17.1	Data sheet status . . . . .	59
6.5	Communication controller interface . . . . .	10	17.2	Definitions . . . . .	59
6.5.1	Bus activity and idle detection . . . . .	10	17.3	Disclaimers . . . . .	59
6.6	Bus error detection . . . . .	11	17.4	Licenses . . . . .	60
6.7	Interrupt generation . . . . .	11	17.5	Trademarks . . . . .	60
6.8	Operating modes . . . . .	12	<b>18</b>	<b>Contact information</b> . . . . .	<b>60</b>
6.8.1	Operating mode transitions . . . . .	12	<b>19</b>	<b>Contents</b> . . . . .	<b>61</b>
6.8.1.1	AS_PowerOff . . . . .	12			
6.8.1.2	AS_Reset . . . . .	12			
6.8.1.3	AS_Standby . . . . .	12			
6.8.1.4	AS_Sleep . . . . .	13			
6.8.1.5	AS_Normal . . . . .	13			
6.8.1.6	Operating mode transition diagram . . . . .	15			
6.9	Branch operating modes . . . . .	16			
6.9.1	Branch operating mode transitions . . . . .	16			
6.9.1.1	Branch_Off . . . . .	16			
6.9.1.2	Branch_LowPower . . . . .	16			
6.9.1.3	Branch_Disabled . . . . .	17			
6.9.1.4	Branch_FailSilent . . . . .	17			
6.9.1.5	Branch_TxOnly1 . . . . .	17			
6.9.1.6	Branch_TxOnly2 . . . . .	17			
6.9.1.7	Branch_Normal . . . . .	17			
6.9.1.8	Branch operating mode transition diagram . . . . .	19			
6.10	SPI interface . . . . .	20			
6.10.1	Register access . . . . .	20			

Please be aware that important notices concerning this document and the product(s) described herein, have been included in section 'Legal information'.

© NXP B.V. 2012.

All rights reserved.

For more information, please visit: <http://www.nxp.com>

For sales office addresses, please send an email to: [salesaddresses@nxp.com](mailto:salesaddresses@nxp.com)

Date of release: 23 October 2012

Document identifier: TJA1085