

RoHS Compliant Product
A suffix of "-C" specifies halogen & lead-free

FEATURES

- Low forward voltage drop
- High current capability
- High reliability
- High surge current capability
- Epitaxial construction

MECHANICAL DATA

- Case: Molded plastic
- Epoxy: UL94V-0 rate flame retardant
- Lead: Lead solderable per MIL-STD-202 method 208 guaranteed
- Polarity: As Marked
- Mounting position: Any
- Weight: 1.62 grams (approximate)

TO-262 (I²-PACK)

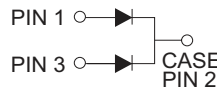
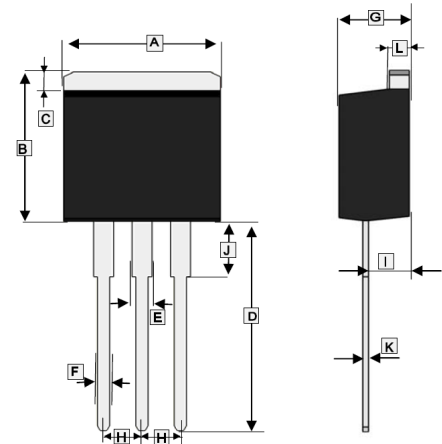

REF.	Millimeter		REF.	Millimeter	
	Min.	Max.		Min.	Max.
A	10.0	10.31	G	4.47	4.7
B	10.0	10.5	H	2.54 BSC	
C	1.27	1.4	I	2.5	2.9
D	13.7	14.1	J	4.0	4.2
E	1.2	1.4	K	0.25	0.35
F	0.68	0.91	L	1.15	1.37

MAXIMUM RATINGS AND ELECTRICAL CHARACTERISTICS

(Rating 25°C ambient temperature unless otherwise specified. Single phase half wave, 60Hz, resistive or inductive load.
For capacitive load, de-rate current by 20%.)

Parameter		Symbol	Rating	Unit
Maximum Recurrent Peak Reverse Voltage		V_{RRM}	100	V
Working Peak Reverse Voltage		V_{RSM}	100	V
Maximum DC Blocking Voltage		V_{DC}	100	V
Maximum Average Forward Rectified Current	Per Leg	I_F	10	A
	Per Device		20	
Peak Forward Surge Current, 8.3 ms single half sine-wave superimposed on rated load (JEDEC method)		I_{FSM}	320	A
Typical Instantaneous Forward Voltage	$I_F=10A, T_A=25^\circ C$, per leg	V_F	0.73	V
	$I_F=10A, T_A=125^\circ C$, per leg		0.59	
Maximum Instantaneous Forward Voltage	$I_F=10A, T_A=25^\circ C$, per leg		0.76	
	$I_F=10A, T_A=125^\circ C$, per leg		0.62	
Maximum DC Reverse Current at Rated DC Blocking Voltage ⁴	$T_A=25^\circ C$	I_R	5	μA
	$T_A=125^\circ C$		5	mA
Typical Junction Capacitance ¹		C_J	425	pF
Typical Thermal Resistance ²		$R_{\theta JC}$	6	$^\circ C / W$
Typical Thermal Resistance ³		$R_{\theta JA}$	25	$^\circ C / W$
Operating Temperature Range T_J		T_J	175	$^\circ C$
Storage Temperature Range T_{STG}		T_{STG}	-65~175	$^\circ C$

Notes:

1. Measured at 1MHz and applied reverse voltage of 4.0V D.C.
2. Thermal Resistance Junction to Case.
3. Thermal Resistance Junction to Ambient.
4. Pulse test: 300uS pulse width, 1% duty cycle.

RATINGS AND CHARACTERISTIC CURVES

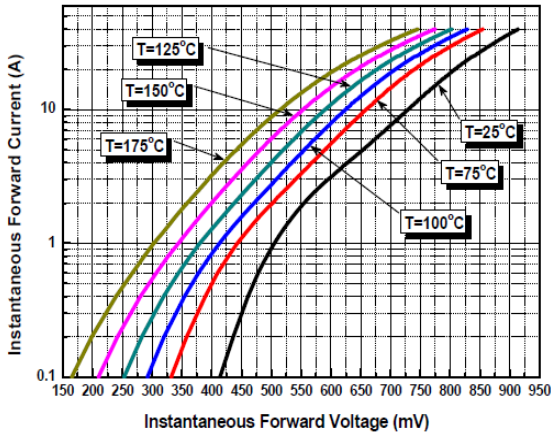

Figure 1. Typical Forward Characteristics per Diode

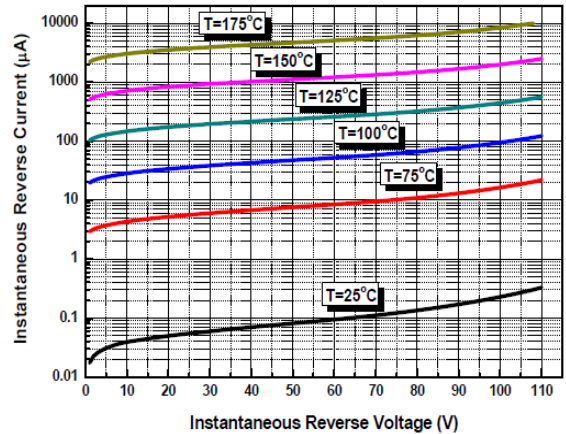

Figure 2. Typical Reverse Characteristics per Diode

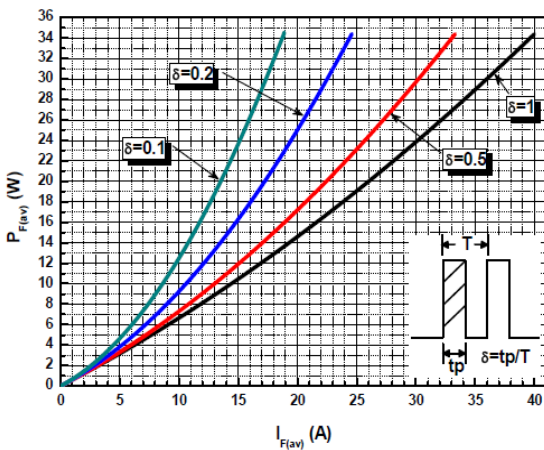

Figure 3. Average Forward Power Dissipation per Diode

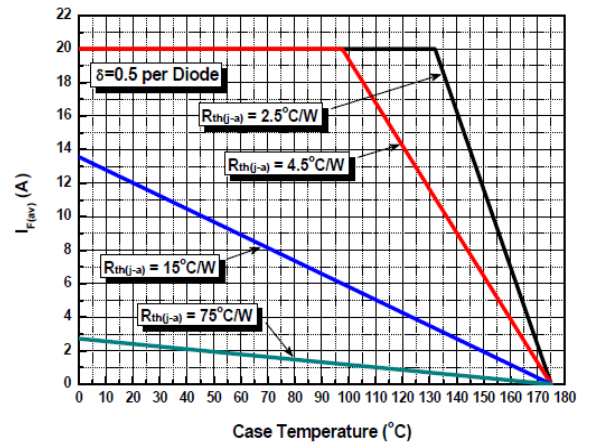

Figure 4. Current Derating Curves

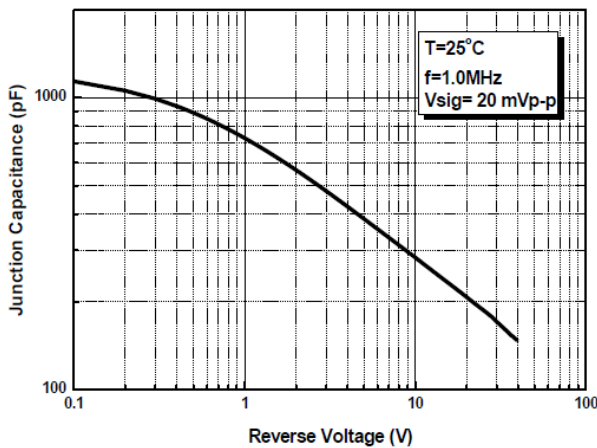

Figure 5. Typical Junction Capacitance per Diode